

AAVP



HIGH PRESSURE WITH BACKWARD IMPELLER

MANUFACTURING FEATURES:

- Fan made of Fe360 sheet. The fan paint finish is based on a Qualicoat polyester powder coating stoved at 200°C, with an average film thickness of 70 microns. Average heat resistance of coating is 180°C with peaks of 200°C.
- Fully welded housing.
- High efficiency simple inlet backward curved impeller made of Fe360 sheet statically and dynamically balanced. Impellers are painted with epoxy primer that resists temperatures up to 300°C.
- Standard asynchronous squirrel-cage motor with IP-55 protection and class F insulation. Manufactured with standard voltages: 230/400V 50Hz in three phase motors up to 4kW and 400/690V 50Hz for higher powers.
- Standard orientation LG270.
- It allows adjusting the orientation locally from models 400 to 630. Models sizes from 710 to 1120 size the orientation is fixed.

APPLICATIONS:

Designed for inline installation, they are suitable for:

- Industrial applications, extraction or injection of air.
- Cooling of machines and parts.
- Clean and slightly dusty air transport.
- Exhaust after filters, separators and cyclones.
- Pneumatic transport.
- Maximum working temperature: carried air: 130°C, ambient 60°C.

UNDER REQUEST:

- 60Hz fans and special voltages.
- 2 speed motors.
- Spark-proof fans with ATEX certified motor.
- Fan for air working temperatures up to 250°C with R/R (cooling impeller).
- Hot-dipped galvanised or stainless steel fans.
- Orientation: RD0, RD45, RD90, RD135, RD180, RD225, RD270, RD315, LG0, LG45, LG90, LG135, LG180. LG225, LG315.

Accessories



AC



BAD



EI



FILTRO
EMC



INT



RA



RI



SFC

Technical data

Three-phase motor / 2 poles

Code	Model	R.P.M.	Rated I. (A) 400V	Rated power kW	Max. Airflow m3/h	Sound db (A)*	Weight	Connect. diagram
502604016	AAVP/N 400 T2 0,55kW	2800	1,29	0,55	470	64	51	1
502604017	AAVP/N 400 T2 0,75kW	2800	1,58	0,75	650	64	55	1
502604518	AAVP/N 451 T2 1,1kW	2800	2,33	1,10	720	65	61	1
502604519	AAVP/N 452 T2 1,5kW	2800	3,14	1,50	870	66	67	1
502605027	AAVP/N 502 T2 2,2kW	2800	4,58	2,20	1.080	68	75	1
502605629	AAVP/N 562 T2 3kW	2870	5,92	3	1.230	71	99	1
502605632	AAVP/N 563 T2 4kW	2890	7,63	4	1.620	71	107	1
502606334	AAVP/N 632 T2 5,5kW	2900	10,6	5,50	1.620	74	145	1
502606336	AAVP/N 633 T2 7,5kW	2900	14,1	7,50	2.520	75	145	1
502607121	AAVP/N 712 T2 11kW	2930	20,8	11	2.520	77	222	1
502607124	AAVP/N 713 T2 15kW	2930	27,4	15	3.240	78	222	1
502608026	AAVP/N 802 T2 18,5kW	2935	34,4	18,50	3.600	80	280	1
502608028	AAVP/N 803 T2 22kW	2940	39,8	22	4.680	80	336	1
502609030	AAVP/N 902 T2 30kW	2950	56,6	30	3.960	84	508	1
502609031	AAVP/N 903 T2 37kW	2955	66,7	37	5.400	85	508	1
502610035	AAVP/N 1002 T2 55kW	2965	95	55	7.200	91	780	1
502610037	AAVP/N 1003 T2 75kW	2965	130	75	9.000	92	924	1
502611238	AAVP/N 1122 T2 90kW	2970	156	90	7.920	97	1.090	1
502611222	AAVP/N 1123 T2 110kW	2975	188	110	12.000	99	1.270	1
507405019	AAVP/NR 501 T2 1,5kW	2800	3,14	1,50	940	68	71	1
507405627	AAVP/NR 562 T2 2,2kW	2800	4,58	2,20	940	71	86	1
507405629	AAVP/NR 563 T2 3kW	2870	5,92	3	1.370	71	98	1
507406332	AAVP/NR 632 T2 4kW	2890	7,63	4	1.370	74	131	1
507406334	AAVP/NR 633 T2 5,5kW	2900	10,6	5,50	1.800	75	143	1
507407136	AAVP/NR 711 T2 7,5kW	2900	14,1	7,50	1.800	77	205	1
507407121	AAVP/NR 713 T2 11kW	2930	20,8	11	2.880	78	218	1
507408024	AAVP/NR 802 T2 15kW	2930	27,4	15	3.240	81	256	1
507408026	AAVP/NR 803 T2 18,5kW	2935	34,4	18,50	4.320	81	268	1
507409028	AAVP/NR 902 T2 22kW	2940	39,8	22	3.600	84	416	1
507409030	AAVP/NR 903 T2 30kW	2950	56,6	30	5.400	84	442	1
507410033	AAVP/NR 1002 T2 45kW	2960	78	45	6.120	89	680	1
507410035	AAVP/NR 1003 T2 55kW	2965	95	55	7.920	91	765	1
507411237	AAVP/NR 1122 T2 75kW	2965	130	75	7.920	96	1.085	1
507409038	AAVP/NR 1123 T2 90kW	2970	156	90	12.000	98	1.050	1

Notes:

* Total sound pressure level at the point of maximum flow measured in dB(A) in the suction measured in free field at a distance of 6m from the source

Dimensions

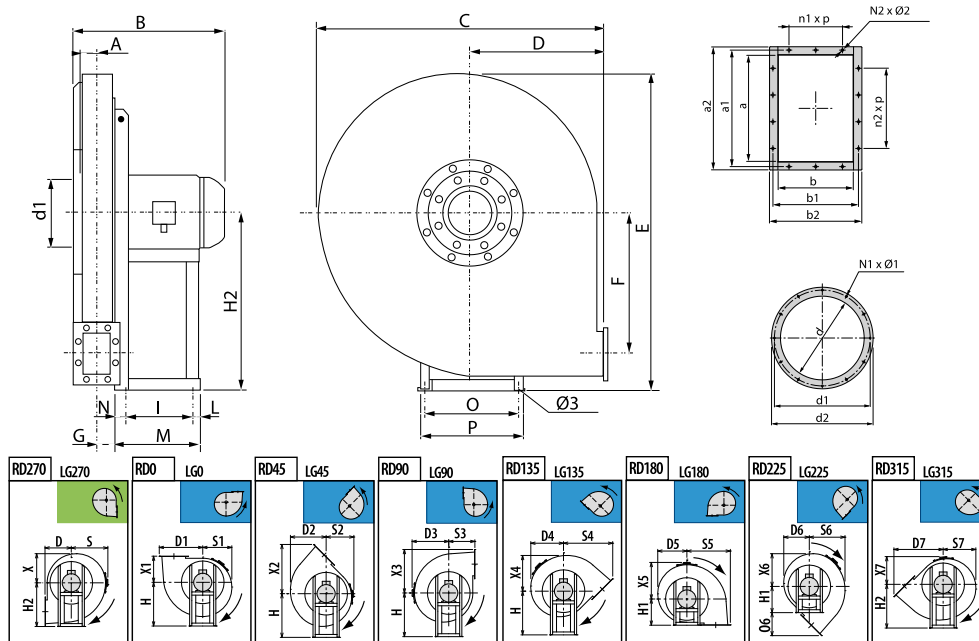

Model	A	B	C	D	D1	D2	D3	D4	D5
AAVP/N 400 T2 0,55kW	45	344	620	280	350	314	340	302	283
AAVP/N 400 T2 0,75kW	45	344	620	280	350	314	340	302	283
AAVP/N 451 T2 1,1kW	50	353	675	300	387	350	375	335	314
AAVP/N 452 T2 1,5kW	50	400	675	300	387	350	375	335	314
AAVP/N 502 T2 2,2kW	57	410	745	335	430	386	410	370	346
AAVP/N 562 T2 3kW	65	457	835	375	487	438	460	418	390
AAVP/N 563 T2 4kW	65	478	835	375	487	438	460	418	390
AAVP/N 632 T2 5,5kW	73	530	940	425	545	493	515	472	440
AAVP/N 633 T2 7,5kW	73	530	940	425	545	493	515	472	440
AAVP/N 712 T2 11kW	83	650	1045	475	606	547	570	522	493
AAVP/N 713 T2 15kW	83	650	1045	475	606	547	570	522	493
AAVP/N 802 T2 18,5kW	90	667	1170	530	678	622	640	592	555
AAVP/N 803 T2 22kW	90	748	1170	530	678	622	640	592	555
AAVP/N 902 T2 30kW	103	874	1315	600	759	696	715	668	628
AAVP/N 903 T2 37kW	103	874	1315	600	759	696	715	668	628
AAVP/N 1002 T2 55kW	110	1043	1460	670	845	775	790	735	690
AAVP/N 1003 T2 75kW	110	1046	1460	670	845	775	790	735	690
AAVP/N 1122 T2 90kW	115	1073	1630	750	950	898	880	857	770
AAVP/N 1123 T2 110kW	115	1285	1630	750	950	898	880	857	770
AAVP/NR 501 T2 1,5kW	57	410	745	335	430	386	410	370	346
AAVP/NR 562 T2 2,2kW	65	426	835	375	487	438	460	418	390

Model	A	B	C	D	D1	D2	D3	D4	D5
AAVP/NR 563 T2 3kW	65	457	835	375	487	438	460	418	390
AAVP/NR 632 T2 4kW	73	490	940	425	545	493	515	472	440
AAVP/NR 633 T2 5,5kW	73	530	940	425	545	493	515	472	440
AAVP/NR 711 T2 7,5kW	83	545	1045	475	606	547	570	522	493
AAVP/NR 713 T2 11kW	83	650	1045	475	606	547	570	522	493
AAVP/NR 802 T2 15kW	90	667	1170	530	678	622	640	592	555
AAVP/NR 803 T2 18,5kW	90	667	1170	530	678	622	640	592	555
AAVP/NR 902 T2 22kW	103	766	1315	600	759	696	715	668	628
AAVP/NR 903 T2 30kW	103	874	1315	600	759	696	715	668	628
AAVP/NR 1002 T2 45kW	110	935	1460	670	845	775	790	735	690
AAVP/NR 1003 T2 55kW	110	1043	1460	670	845	775	790	735	690
AAVP/NR 1122 T2 75kW	115	1073	1630	750	950	898	880	857	770
AAVP/NR 1123 T2 90kW	115	1073	1630	750	950	898	880	857	770

Model	D6	D7	E	F	G	H	H1	H2	I
AAVP/N 400 T2 0,55kW	293	445	658	267	42	375	375	375	121
AAVP/N 400 T2 0,75kW	293	445	658	267	42	375	375	375	121
AAVP/N 451 T2 1,1kW	319	486	714	298	47	400	400	400	121
AAVP/N 452 T2 1,5kW	319	486	714	298	47	400	400	400	133
AAVP/N 502 T2 2,2kW	350	541	796	334	52	450	450	450	133
AAVP/N 562 T2 3kW	392	610	890	379	58	500	500	500	197
AAVP/N 563 T2 4kW	392	610	890	379	58	500	500	500	197
AAVP/N 632 T2 5,5kW	438	688	1000	427	64	560	560	560	237
AAVP/N 633 T2 7,5kW	438	688	1000	427	64	560	560	560	237
AAVP/N 712 T2 11kW	489	764	1123	478	72	630	630	630	337
AAVP/N 713 T2 15kW	489	764	1123	478	72	630	630	630	337
AAVP/N 802 T2 18,5kW	545	854	1265	539	80	710	710	710	337
AAVP/N 803 T2 22kW	545	854	1265	539	80	710	710	710	357
AAVP/N 902 T2 30kW	617	961	1428	608	89	800	800	800	381
AAVP/N 903 T2 37kW	617	961	1428	608	89	800	800	800	381
AAVP/N 1002 T2 55kW	670	1074	1590	681	99	900	900	900	501
AAVP/N 1003 T2 75kW	670	1074	1590	681	99	900	900	900	591
AAVP/N 1122 T2 90kW	713	1202	1770	766	111	1000	1000	1000	591
AAVP/N 1123 T2 110kW	713	1202	1770	766	111	1000	1000	1000	675
AAVP/NR 501 T2 1,5kW	350	541	796	334	52	450	450	450	133
AAVP/NR 562 T2 2,2kW	392	610	890	379	58	500	500	500	133
AAVP/NR 563 T2 3kW	392	610	890	379	58	500	500	500	197
AAVP/NR 632 T2 4kW	438	688	1000	427	64	560	560	560	197
AAVP/NR 633 T2 5,5kW	438	688	1000	427	64	560	560	560	237
AAVP/NR 711 T2 7,5kW	489	764	1123	478	72	630	630	630	237

Model	D6	D7	E	F	G	H	H1	H2	I
AAVP/NR 713 T2 11kW	489	764	1123	478	72	630	630	630	337
AAVP/NR 802 T2 15kW	545	854	1265	539	80	710	710	710	337
AAVP/NR 803 T2 18,5kW	545	854	1265	539	80	710	710	710	337
AAVP/NR 902 T2 22kW	617	961	1428	608	89	800	800	800	357
AAVP/NR 903 T2 30kW	617	961	1428	608	89	800	800	800	381
AAVP/NR 1002 T2 45kW	670	1074	1590	681	99	900	900	900	421
AAVP/NR 1003 T2 55kW	670	1074	1590	681	99	900	900	900	501
AAVP/NR 1122 T2 75kW	713	1202	1770	766	111	1000	1000	1000	591
AAVP/NR 1123 T2 90kW	713	1202	1770	766	111	1000	1000	1000	591

Model	L	M	N	N1 x Ø1	N2 x Ø2	O	O6	P	S
AAVP/N 400 T2 0,55kW	26	196	49	8 x 8	4x10	203	165	225	340
AAVP/N 400 T2 0,75kW	45	211	45	8 x 8	4x10	203	165	225	340
AAVP/N 451 T2 1,1kW	45	211	45	8 x 8	4x10	203	186	225	375
AAVP/N 452 T2 1,5kW	58	246	55	8 x 8	4x10	234	186	260	375
AAVP/N 502 T2 2,2kW	58	246	55	8 x 8	6x10	234	206	260	410
AAVP/N 562 T2 3kW	49	276	30	8 x 8	6x12	289	235	324	460
AAVP/N 563 T2 4kW	49	276	30	8 x 8	6x12	289	235	324	460
AAVP/N 632 T2 5,5kW	59	336	40	8 x 8	6x12	337	263	372	515
AAVP/N 633 T2 7,5kW	59	336	40	8 x 8	6x12	337	263	372	515
AAVP/N 712 T2 11kW	49	436	50	8 x 10	6x12	395	289	440	570
AAVP/N 713 T2 15kW	49	436	50	8 x 10	6x12	395	289	440	570
AAVP/N 802 T2 18,5kW	49	436	50	8 x 12	8x12	395	324	440	640
AAVP/N 803 T2 22kW	33	460	70	8 x 12	8x12	434	324	488	640
AAVP/N 902 T2 30kW	39	500	80	8 x 12	8x12	506	361	568	715
AAVP/N 903 T2 37kW	39	500	80	8 x 12	8x12	506	361	568	715
AAVP/N 1002 T2 55kW	39	600	60	8 x 12	10x12	604	174	690	790
AAVP/N 1003 T2 75kW	46	697	60	8 x 12	10x12	690	174	750	790
AAVP/N 1122 T2 90kW	46	697	60	12 x 12	10x12	690	452	750	880
AAVP/N 1123 T2 110kW	45	800	80	12 x 12	10x12	760	452	865	880
AAVP/NR 501 T2 1,5kW	58	246	55	8 x 8	6x10	234	206	260	410
AAVP/NR 562 T2 2,2kW	58	246	55	8 x 8	6x12	234	235	260	460
AAVP/NR 563 T2 3kW	49	276	30	8 x 8	6x12	289	235	324	460
AAVP/NR 632 T2 4kW	49	276	30	8 x 8	6x12	289	263	324	515
AAVP/NR 633 T2 5,5kW	59	336	40	8 x 8	6x12	337	263	372	515
AAVP/NR 711 T2 7,5kW	59	336	40	8 x 10	6x12	337	289	372	570
AAVP/NR 713 T2 11kW	49	436	50	8 x 10	6x12	395	289	440	570
AAVP/NR 802 T2 15kW	49	436	50	8 x 12	8x12	395	324	440	640
AAVP/NR 803 T2 18,5kW	49	436	50	8 x 12	8x12	395	324	440	640
AAVP/NR 902 T2 22kW	33	460	70	8 x 12	8x12	434	361	488	715

Model	L	M	N	N1 x Ø1	N2 x Ø2	O	O6	P	S
AAVP/NR 903 T2 30kW	39	500	80	8 x 12	8x12	506	361	568	715
AAVP/NR 1002 T2 45kW	39	540	80	8 x 12	10x12	556	174	616	790
AAVP/NR 1003 T2 55kW	39	600	60	8 x 12	10x12	604	174	690	790
AAVP/NR 1122 T2 75kW	46	697	60	12 x 12	10x12	690	452	750	880
AAVP/NR 1123 T2 90kW	46	697	60	12 x 12	10x12	690	452	750	880

Model	S1	S2	S3	S4	S5	S6	S7	X	X1
AAVP/N 400 T2 0,55kW	283	293	280	445	350	314	302	283	280
AAVP/N 400 T2 0,75kW	283	293	280	445	350	314	302	283	280
AAVP/N 451 T2 1,1kW	314	319	300	486	387	350	335	314	300
AAVP/N 452 T2 1,5kW	314	319	300	486	387	350	335	314	300
AAVP/N 502 T2 2,2kW	346	350	335	541	430	386	370	346	335
AAVP/N 562 T2 3kW	390	392	375	610	487	438	418	390	375
AAVP/N 563 T2 4kW	390	392	375	610	487	438	418	390	375
AAVP/N 632 T2 5,5kW	440	438	425	688	545	493	472	440	425
AAVP/N 633 T2 7,5kW	440	438	425	688	545	493	472	440	425
AAVP/N 712 T2 11kW	493	489	475	764	606	547	522	493	475
AAVP/N 713 T2 15kW	493	489	475	764	606	547	522	493	475
AAVP/N 802 T2 18,5kW	555	545	530	854	678	622	592	555	530
AAVP/N 803 T2 22kW	555	545	530	854	678	622	592	555	530
AAVP/N 902 T2 30kW	628	617	600	961	759	696	668	628	600
AAVP/N 903 T2 37kW	628	617	600	961	759	696	668	628	600
AAVP/N 1002 T2 55kW	690	670	670	1074	845	775	735	690	670
AAVP/N 1003 T2 75kW	690	670	670	1074	845	775	735	690	670
AAVP/N 1122 T2 90kW	770	713	750	1202	950	898	857	770	750
AAVP/N 1123 T2 110kW	770	713	750	1202	950	898	857	770	750
AAVP/NR 501 T2 1,5kW	346	350	335	541	430	386	370	346	335
AAVP/NR 562 T2 2,2kW	390	392	375	610	487	438	418	390	375
AAVP/NR 563 T2 3kW	390	392	375	610	487	438	418	390	375
AAVP/NR 632 T2 4kW	440	438	425	688	545	493	472	440	425
AAVP/NR 633 T2 5,5kW	440	438	425	688	545	493	472	440	425
AAVP/NR 711 T2 7,5kW	493	489	475	764	606	547	522	493	475
AAVP/NR 713 T2 11kW	493	489	475	764	606	547	522	493	475
AAVP/NR 802 T2 15kW	555	545	530	854	678	622	592	555	530
AAVP/NR 803 T2 18,5kW	555	545	530	854	678	622	592	555	530
AAVP/NR 902 T2 22kW	628	617	600	961	759	696	668	628	600
AAVP/NR 903 T2 30kW	628	617	600	961	759	696	668	628	600
AAVP/NR 1002 T2 45kW	690	670	670	1074	845	775	735	690	670
AAVP/NR 1003 T2 55kW	690	670	670	1074	845	775	735	690	670
AAVP/NR 1122 T2 75kW	770	713	750	1202	950	898	857	770	750

Model	S1	S2	S3	S4	S5	S6	S7	X	X1
AAVP/NR 1123 T2 90kW	770	713	750	1202	950	898	857	770	750

Model	X2	X3	X4	X5	X6	X7	a	a1	a2
AAVP/N 400 T2 0,55kW	445	350	314	340	302	293	105	139	165
AAVP/N 400 T2 0,75kW	445	350	314	340	302	293	105	139	165
AAVP/N 451 T2 1,1kW	486	387	350	375	335	319	117	151	177
AAVP/N 452 T2 1,5kW	486	387	350	375	335	319	117	151	177
AAVP/N 502 T2 2,2kW	541	430	386	410	370	350	131	165	191
AAVP/N 562 T2 3kW	610	487	438	460	418	392	146	182	216
AAVP/N 563 T2 4kW	610	487	438	460	418	392	146	182	216
AAVP/N 632 T2 5,5kW	688	545	493	515	472	438	166	200	236
AAVP/N 633 T2 7,5kW	688	545	493	515	472	438	166	200	236
AAVP/N 712 T2 11kW	764	606	547	570	522	489	185	219	255
AAVP/N 713 T2 15kW	764	606	547	570	522	489	185	219	255
AAVP/N 802 T2 18,5kW	854	678	622	640	592	545	207	241	277
AAVP/N 803 T2 22kW	854	678	622	640	592	545	207	241	277
AAVP/N 902 T2 30kW	961	759	696	715	668	617	231	265	301
AAVP/N 903 T2 37kW	961	759	696	715	668	617	231	265	301
AAVP/N 1002 T2 55kW	1074	845	775	790	735	670	258	292	328
AAVP/N 1003 T2 75kW	1074	845	775	790	735	670	258	292	328
AAVP/N 1122 T2 90kW	1202	950	898	880	857	713	288	332	368
AAVP/N 1123 T2 110kW	1202	950	898	880	857	713	288	332	368
AAVP/NR 501 T2 1,5kW	541	430	386	410	370	350	131	165	191
AAVP/NR 562 T2 2,2kW	610	487	438	460	418	392	146	182	216
AAVP/NR 563 T2 3kW	610	487	438	460	418	392	146	182	216
AAVP/NR 632 T2 4kW	688	545	493	515	472	438	166	200	236
AAVP/NR 633 T2 5,5kW	688	545	493	515	472	438	166	200	236
AAVP/NR 711 T2 7,5kW	764	606	547	570	522	489	185	219	255
AAVP/NR 713 T2 11kW	764	606	547	570	522	489	185	219	255
AAVP/NR 802 T2 15kW	854	678	622	640	592	545	207	241	277
AAVP/NR 803 T2 18,5kW	854	678	622	640	592	545	207	241	277
AAVP/NR 902 T2 22kW	961	759	696	715	668	617	231	265	301
AAVP/NR 903 T2 30kW	961	759	696	715	668	617	231	265	301
AAVP/NR 1002 T2 45kW	1074	845	775	790	735	670	258	292	328
AAVP/NR 1003 T2 55kW	1074	845	775	790	735	670	258	292	328
AAVP/NR 1122 T2 75kW	1202	950	898	880	857	713	288	332	368
AAVP/NR 1123 T2 90kW	1202	950	898	880	857	713	288	332	368

Model	b	b1	b2	d	d1	d2	n1 x p	n2 x p	Ø3
AAVP/N 400 T2 0,55kW	76	110	136	145	182	215	-	-	10

Model	b	b1	b2	d	d1	d2	n1 x p	n2 x p	Ø3
AAVP/N 400 T2 0,75kW	76	110	136	145	182	215	-	-	10
AAVP/N 451 T2 1,1kW	85	119	145	165	200	235	-	-	10
AAVP/N 452 T2 1,5kW	85	119	145	165	200	235	-	-	10
AAVP/N 502 T2 2,2kW	95	129	155	185	219	250	-	1x100	10
AAVP/N 562 T2 3kW	105	139	175	205	241	275	-	1x112	12
AAVP/N 563 T2 4kW	105	139	175	205	241	275	-	1x112	12
AAVP/N 632 T2 5,5kW	117	151	187	228	265	298	-	1x112	12
AAVP/N 633 T2 7,5kW	117	151	187	228	265	298	-	1x112	12
AAVP/N 712 T2 11kW	131	165	201	255	292	325	-	1x112	14
AAVP/N 713 T2 15kW	131	165	201	255	292	325	-	1x112	14
AAVP/N 802 T2 18,5kW	148	182	218	285	332	365	1x112	1x112	14
AAVP/N 803 T2 22kW	148	182	218	285	332	365	1x112	1x112	17
AAVP/N 902 T2 30kW	166	200	236	320	366	400	1x112	1x112	19
AAVP/N 903 T2 37kW	166	200	236	320	366	400	1x112	1x112	19
AAVP/N 1002 T2 55kW	185	219	255	360	405	440	1x112	2x112	19
AAVP/N 1003 T2 75kW	185	219	255	360	405	440	1x112	2x112	21
AAVP/N 1122 T2 90kW	205	249	285	405	448	485	1x125	2x125	21
AAVP/N 1123 T2 110kW	205	249	285	405	448	485	1x125	2x125	24
AAVP/NR 501 T2 1,5kW	95	129	155	185	219	250	-	1x100	10
AAVP/NR 562 T2 2,2kW	105	139	175	205	241	275	-	1x112	10
AAVP/NR 563 T2 3kW	105	139	175	205	241	275	-	1x112	12
AAVP/NR 632 T2 4kW	117	151	187	228	265	298	-	1x112	12
AAVP/NR 633 T2 5,5kW	117	151	187	228	265	298	-	1x112	12
AAVP/NR 711 T2 7,5kW	131	165	201	255	292	325	-	1x112	12
AAVP/NR 713 T2 11kW	131	165	201	255	292	325	-	1x112	14
AAVP/NR 802 T2 15kW	148	182	218	285	332	365	1x112	1x112	14
AAVP/NR 803 T2 18,5kW	148	182	218	285	332	365	1x112	1x112	14
AAVP/NR 902 T2 22kW	166	200	236	320	366	400	1x112	1x112	17
AAVP/NR 903 T2 30kW	166	200	236	320	366	400	1x112	1x112	19
AAVP/NR 1002 T2 45kW	185	219	255	360	405	440	1x112	2x112	19
AAVP/NR 1003 T2 55kW	185	219	255	360	405	440	1x112	2x112	19
AAVP/NR 1122 T2 75kW	205	249	285	405	448	485	1x125	2x125	21
AAVP/NR 1123 T2 90kW	205	249	285	405	448	485	1x125	2x125	21

Wiring diagram

DIAGRAM Nº 1

230/400V

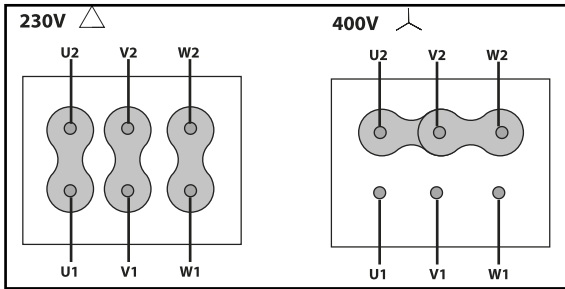

400/690V

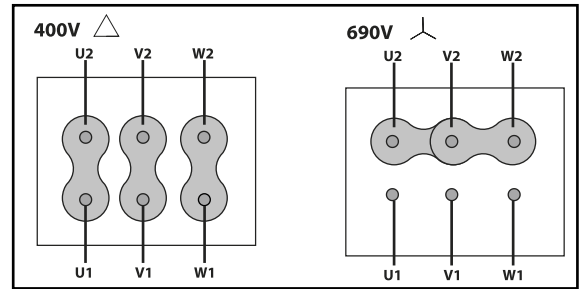

CHARACTERISCTIC CURVE

1	AAVP/N 400 T2 0,55kW	2	AAVP/N 400 T2 0,75kW	3	AAVP/N 451 T2 1,1kW	4	AAVP/N 452 T2 1,5kW
5	AAVP/N 502 T2 2,2kW	6	AAVP/N 562 T2 3kW	7	AAVP/N 563 T2 4kW	8	AAVP/N 632 T2 5,5kW
9	AAVP/N 633 T2 7,5kW	10	AAVP/N 712 T2 11kW	11	AAVP/N 713 T2 15kW	12	AAVP/N 802 T2 18,5kW

AIR FLOW - PRESSURE

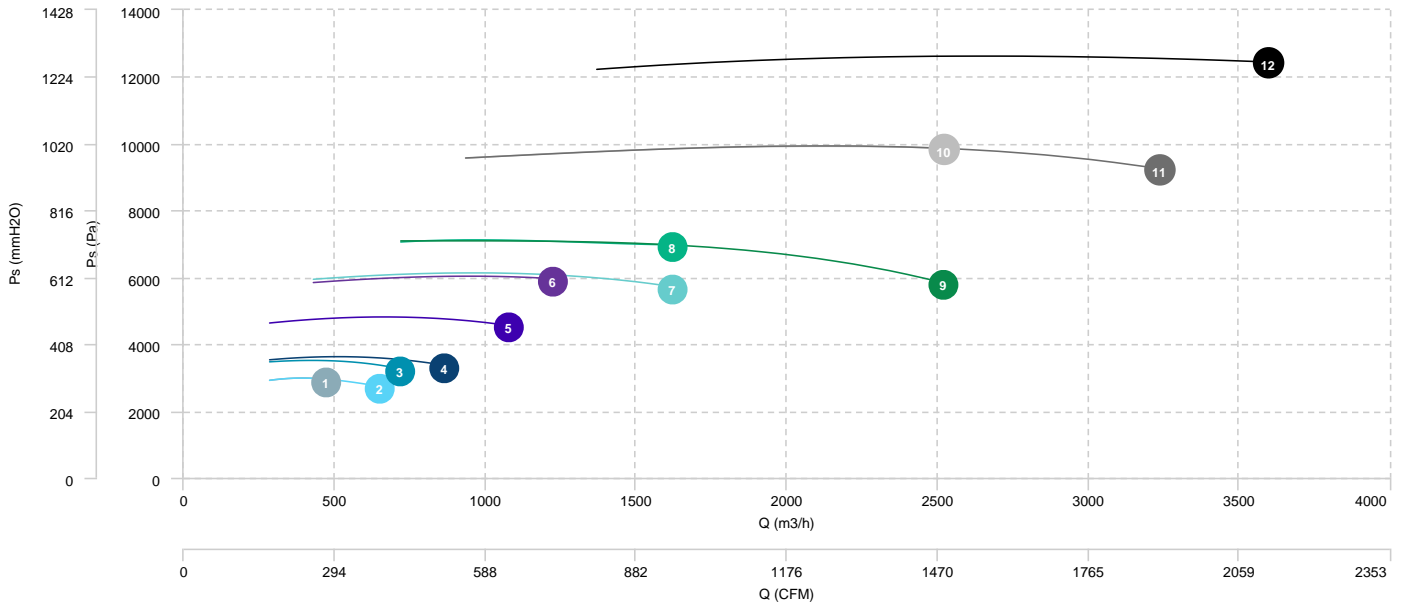

1	AAVP/N 803 T2 22kW	2	AAVP/N 902 T2 30kW	3	AAVP/N 903 T2 37kW	4	AAVP/N 1002 T2 55kW
5	AAVP/N 1003 T2 75kW	6	AAVP/N 1122 T2 90kW	7	AAVP/N 1123 T2 110kW	8	AAVP/NR 501 T2 1,5kW
9	AAVP/NR 562 T2 2,2kW	10	AAVP/NR 563 T2 3kW	11	AAVP/NR 632 T2 4kW		

AIR FLOW - PRESSURE

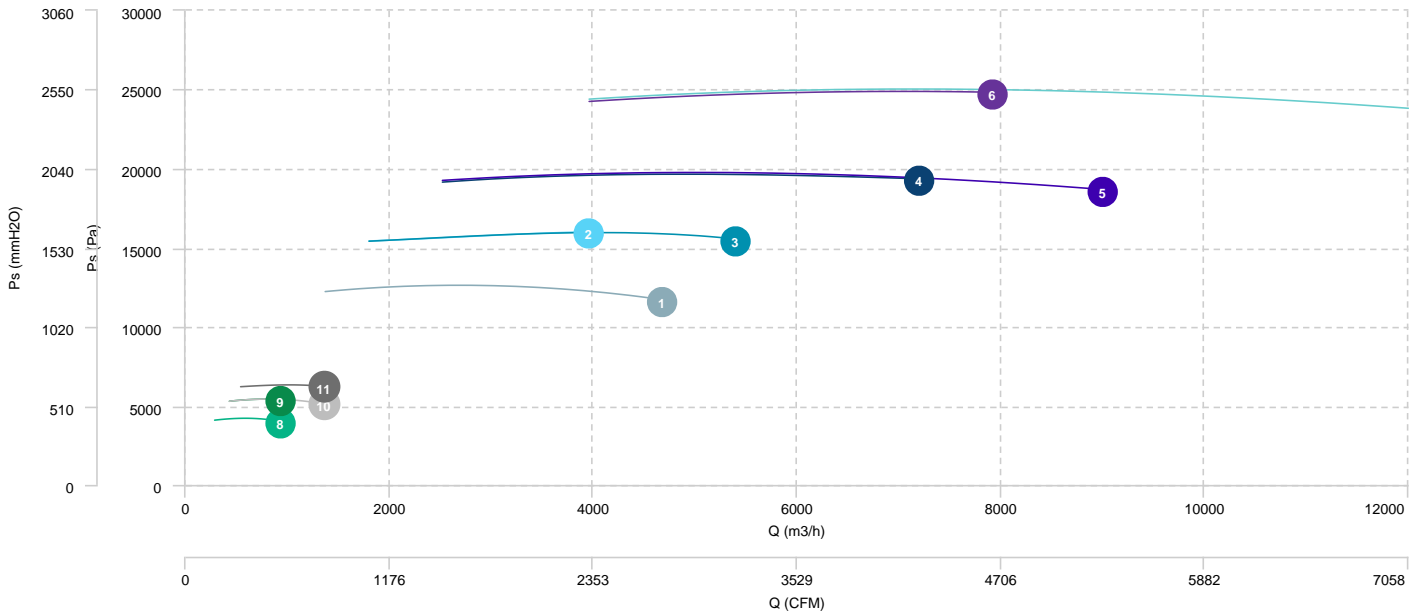

1	AAVP/NR 633 T2 5,5kW	2	AAVP/NR 711 T2 7,5kW	3	AAVP/NR 713 T2 11kW	4	AAVP/NR 802 T2 15kW
5	AAVP/NR 803 T2 18,5kW	6	AAVP/NR 902 T2 22kW	7	AAVP/NR 903 T2 30kW	8	AAVP/NR 1002 T2 45kW
9	AAVP/NR 1003 T2 55kW	10	AAVP/NR 1122 T2 75kW	11	AAVP/NR 1123 T2 90kW		

AIR FLOW - PRESSURE

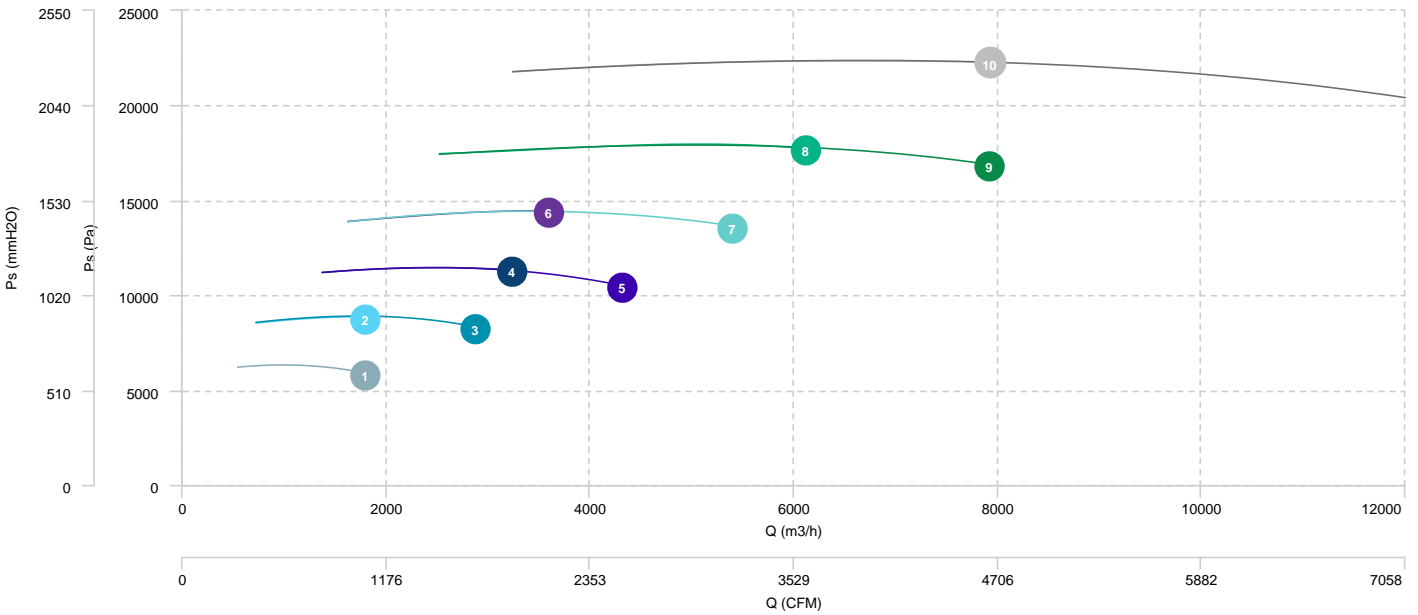

AIR FLOW - ABSORBED POWER

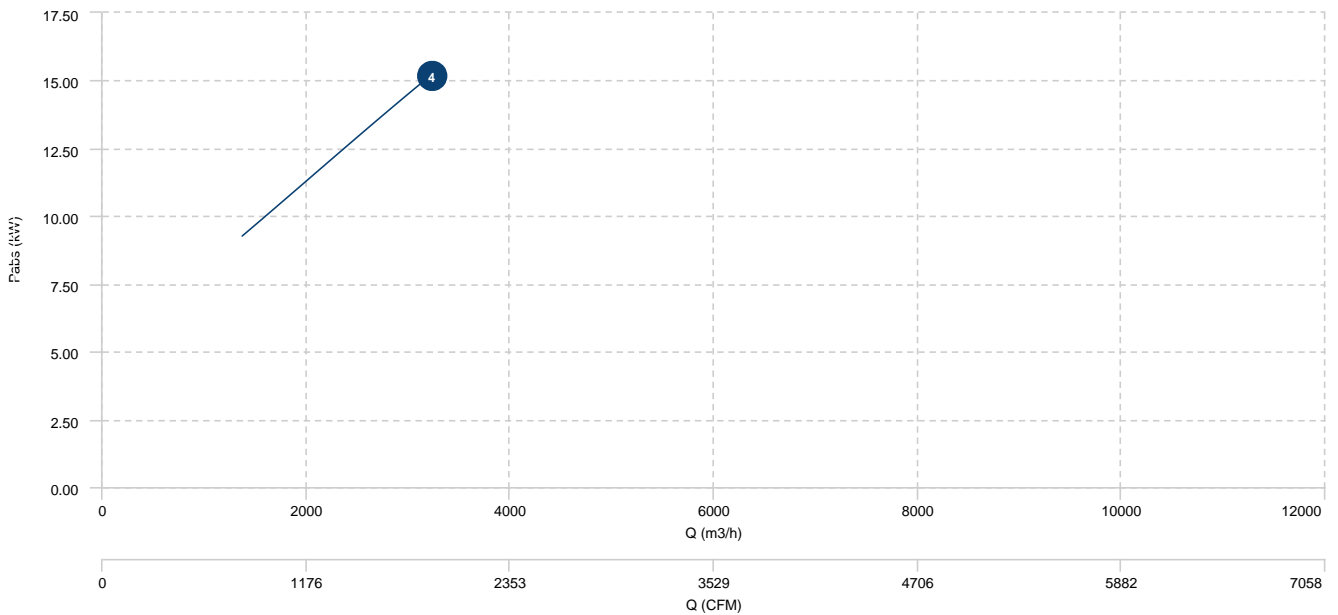

Sound data

Sound / 2 poles

		Sound power Lw dB (A)								
Model		63 Hz	125 Hz	250 Hz	500 Hz	1000 Hz	2000 Hz	4000 Hz	8000 Hz	Total
AAVP/N 400 T2 0,55kW	Inlet	87	81	78	82	81	78	73	67	90
AAVP/N 400 T2 0,75kW	Inlet	87	81	78	82	81	78	73	67	90
AAVP/N 451 T2 1,1kW	Inlet	88	82	79	83	82	79	75	68	91
AAVP/N 452 T2 1,5kW	Inlet	88	82	79	84	82	79	75	68	92
AAVP/N 502 T2 2,2kW	Inlet	91	85	82	86	85	82	77	71	94
AAVP/N 562 T2 3kW	Inlet	94	88	84	89	88	85	80	74	97
AAVP/N 563 T2 4kW	Inlet	94	88	85	89	88	85	81	74	97
AAVP/N 632 T2 5,5kW	Inlet	97	91	88	92	91	88	83	77	100
AAVP/N 633 T2 7,5kW	Inlet	97	92	88	93	91	88	84	78	101
AAVP/N 712 T2 11kW	Inlet	100	94	91	95	94	91	87	80	103
AAVP/N 713 T2 15kW	Inlet	101	95	91	96	95	92	87	81	104
AAVP/N 802 T2 18,5kW	Inlet	103	97	94	98	97	94	89	83	106
AAVP/N 803 T2 22kW	Inlet	103	97	94	98	97	94	90	83	106
AAVP/N 902 T2 30kW	Inlet	106	101	97	102	101	98	93	87	110
AAVP/N 903 T2 37kW	Inlet	107	101	98	103	101	98	94	87	111
AAVP/N 1002 T2 55kW	Inlet	113	107	104	109	107	104	100	93	117
AAVP/N 1003 T2 75kW	Inlet	115	109	106	110	109	106	101	95	118
AAVP/N 1122 T2 90kW	Inlet	120	114	110	115	114	111	106	100	123
AAVP/N 1123 T2 110kW	Inlet	121	115	112	117	115	112	108	101	125
AAVP/NR 501 T2 1,5kW	Inlet	91	85	82	86	85	82	77	71	94
AAVP/NR 562 T2 2,2kW	Inlet	93	88	84	89	87	84	80	73	97
AAVP/NR 563 T2 3kW	Inlet	94	88	85	89	88	85	80	74	97
AAVP/NR 632 T2 4kW	Inlet	97	91	88	92	91	88	83	77	100
AAVP/NR 633 T2 5,5kW	Inlet	97	91	88	93	91	88	84	77	101
AAVP/NR 711 T2 7,5kW	Inlet	100	94	90	95	94	91	86	80	103
AAVP/NR 713 T2 11kW	Inlet	100	94	91	96	94	91	87	80	104
AAVP/NR 802 T2 15kW	Inlet	103	97	94	99	97	94	90	83	107
AAVP/NR 803 T2 18,5kW	Inlet	104	98	95	99	98	95	90	84	107
AAVP/NR 902 T2 22kW	Inlet	106	100	97	102	100	97	93	86	110
AAVP/NR 903 T2 30kW	Inlet	107	101	97	102	101	98	93	87	110
AAVP/NR 1002 T2 45kW	Inlet	112	106	103	107	106	103	99	92	115
AAVP/NR 1003 T2 55kW	Inlet	113	107	104	109	107	104	100	93	117
AAVP/NR 1122 T2 75kW	Inlet	119	113	110	114	113	110	106	99	122
AAVP/NR 1123 T2 90kW	Inlet	120	114	111	116	114	111	107	100	124

erp data

ERP	
Fan type	Centrifugal fan backward blades with casing
Installation category	A
Efficiency category	Static
The fan has to be installed with FSC	No

ERP / 2 poles

Model	Motor power (kW)	Maximum efficiency point data						
		Max. efficiency (%)	Efficiency grade (N) (N)	Air Flow (m3/h)	Ps (Pa)	Pabs (kW)	speed (rpm)	Specific ratio
AAVP/NR 802 T2 15kW	15	72,77	72,38	3.240	11.334,55	15,26	2930	1,00