

## BOX HBF F400



### AXIAL FAN IN SOUNDPROOF CABINET 400°C/2H

#### MANUFACTURING FEATURES

- BOX: Manufactured in galvanised steel sheet with thermalproofing. Soundproofing cabinets with thermo-acoustic insulation, Bs1d0 fire class. Removable panels for easy motor access and fan maintenance.
- Internal fan: HBF F400 Axial fan, circular reinforced frame from size 45 to 80. For larger sizes uses from 90 to 125 we use model HCF F400. Motor-impeller assembly through a modular system. Cast aluminium impeller. Epoxy powder finishing coat to protect against corrosion.
- Standard asynchronous squirrel-cage motor with IP-55 protection and Class H insulation certified 400°C/2H. Manufactured with standard voltages: 230/400V 50Hz in three phase motors up to 4kW and 400/690V 50Hz for higher powers.

## Accessories



BA-400



CPM



INT



INT 400



JE-45



SFC

#### APPLICATIONS

Designed for wall or duct installation, they are suitable for:

- Smoke emergency exhaust with motor inside the hazardous area.
- Cabinet design simplifies installation in rectangular duct systems.
- Maximum working temperature: 60°C.

#### UNDER REQUEST

- Supply 100% reversible impeller.
- Official homologation by the European laboratory APPLUS according to EN 12101-3:2002, EN 12101-3:2002/AC:2005  
 Certification Nr: 0370-CPR-0913

## Technical data

### Three-phase motor / 4 poles

Code	Model	R.P.M.	Rated I. (A) 400V	Rated power kW	Max. Airflow m3/h	Sound db (A)*	Weight	Connect. diagram
26347606__AF	BOX HBF 45 T4 0,75kW (A5:6) F400	1404	1,95	0,75	6.650	47	68	1
26350606__AF	BOX HBF 50 T4 0,75kW (A5:6) F400	1404	1,95	0,75	8.760	49	78	1
26358656__AF	BOX HBF 56 T4 0,75kW (A5:6) F400	1404	1,95	0,75	10.270	54	65	1
26360656__AF	BOX HBF 56 T4 1,1kW (A5:6) F400	1392	2,7	1,10	11.890	53	67	1
26361656__AF	BOX HBF 56 T4 1,5kW (A5:6) F400	1410	3,6	1,50	13.870	54	72	1
26365656__AF	BOX HBF 63 T4 0,75kW (A5:6) F400	1404	1,95	0,75	11.420	57	69	1
26366656__AF	BOX HBF 63 T4 1,1kW (A5:6) F400	1392	2,7	1,10	14.010	58	75	1
26367656__AF	BOX HBF 63 T4 1,5kW (A5:6) F400	1410	3,6	1,50	15.780	54	80	1
26368656__AF	BOX HBF 63 T4 2,2kW (A5:6) F400	1420	4,55	2,20	17.690	55	86	1
26372656__AF	BOX HBF 71 T4 0,75kW (A5:6) F400	1404	1,95	0,75	12.950	62	101	1
26373656__AF	BOX HBF 71 T4 1,1kW (A5:6) F400	1392	2,7	1,10	15.960	61	103	1
26374656__AF	BOX HBF 71 T4 1,5kW (A5:6) F400	1410	3,6	1,50	18.960	60	104	1
26375656__AF	BOX HBF 71 T4 2,2kW (A5:6) F400	1420	4,55	2,20	22.040	58	108	1
26376656__AF	BOX HBF 71 T4 3kW (A5:6) F400	1420	6,12	3	23.900	60	111	1
26384656__AF	BOX HBF 80 T4 3kW (A5:6) F400	1420	6,12	3	29.250	60	123	1
26385656__AF	BOX HBF 80 T4 4kW (A5:6) F400	1428	8,57	4	32.300	61	135	1
26393634__AF	BOX HBF 90 T4 3kW (A3:4) F400	1420	6,12	3	27.600	63	177	1
26394634__AF	BOX HBF 90 T4 4kW (A3:4) F400	1440	8,57	4	32.700	62	189	1
26395634__AF	BOX HBF 90 T4 5,5kW (A3:4) F400	1460	10,5	5,50	39.500	60	202	1
26395638__AF	BOX HBF 90 T4 5,5kW (A3:8) F400	1460	10,5	5,50	32.000	67	191	1
26396634__AF	BOX HBF 90 T4 7,5kW (A3:4) F400	1455	14,1	7,50	44.600	60	216	1
26396638__AF	BOX HBF 90 T4 7,5kW (A3:8) F400	1455	14,1	7,50	37.100	65	205	1
26397634__AF	BOX HBF 90 T4 11kW (A3:4) F400	1470	21,2	11	46.300	62	246	1
26397638__AF	BOX HBF 90 T4 11kW (A3:8) F400	1470	21,2	11	47.600	63	232	1
26398638__AF	BOX HBF 90 T4 15kW (A3:8) F400	1465	28,7	15	52.600	63	260	1
26314634__AF	BOX HBF 100 T4 5,5kW (A3:4) F400	1460	10,5	5,50	45.600	68	188	1
26315634__AF	BOX HBF 100 T4 7,5kW (A3:4) F400	1455	14,1	7,50	51.400	68	202	1
26315638__AF	BOX HBF 100 T4 7,5kW (A3:8) F400	1455	14,1	7,50	39.400	78	205	1
26316634__AF	BOX HBF 100 T4 11kW (A3:4) F400	1470	21,2	11	62.300	67	229	1
26316638__AF	BOX HBF 100 T4 11kW (A3:8) F400	1470	21,2	11	52.500	73	232	1
26317634__AF	BOX HBF 100 T4 15kW (A3:4) F400	1465	28,7	15	65.200	68	257	1
26317638__AF	BOX HBF 100 T4 15kW (A3:8) F400	1465	28,7	15	63.600	70	260	1
26318638__AF	BOX HBF 100 T4 18,5kW (A3:8) F400	1465	35,1	18,50	71.300	70	308	1
26319638__AF	BOX HBF 100 T4 22kW (A3:8) F400	1465	40,5	22	75.100	71	309	1
26323634__AF	BOX HBF 112 T4 5,5kW (A3:4) F400	1460	10,5	5,50	50.600	72	250	1

Code	Model	R.P.M.	Rated I. (A) 400V	Rated power kW	Max. Airflow m3/h	Sound db (A)*	Weight	Connect. diagram
26324634__AF	BOX HBF 112 T4 7,5kW (A3:4) F400	1455	14,1	7,50	59.100	72	322	1
26325634__AF	BOX HBF 112 T4 11kW (A3:4) F400	1470	21,2	11	75.500	69	346	1
26325638__AF	BOX HBF 112 T4 11kW (A3:8) F400	1470	21,2	11	57.600	78	350	1
26326634__AF	BOX HBF 112 T4 15kW (A3:4) F400	1465	28,7	15	86.200	69	371	1
26326638__AF	BOX HBF 112 T4 15kW (A3:8) F400	1465	28,7	15	72.400	76	373	1
26327634__AF	BOX HBF 112 T4 18,5kW (A3:4) F400	1465	35,1	18,50	89.500	70	414	1
26327638__AF	BOX HBF 112 T4 18,5kW (A3:8) F400	1465	35,1	18,50	82.400	74	416	1
26328638__AF	BOX HBF 112 T4 22kW (A3:8) F400	1465	40,5	22	91.800	72	417	1
26329638__AF	BOX HBF 112 T4 30kW (A3:8) F400	1470	56,2	30	99.700	72	471	1
27306634__AF	BOX HBF 125 T4 11kW (A3:4) F400	1470	21,2	11	74.100	80	383	1
27307634__AF	BOX HBF 125 T4 15kW (A3:4) F400	1465	28,7	15	91.200	75	411	1
27308634__AF	BOX HBF 125 T4 18,5kW (A3:4) F400	1465	35,1	18,50	102.000	73	459	1
27308638__AF	BOX HBF 125 T4 18,5kW (A3:8) F400	1465	35,1	18,50	77.800	85	465	1
27309634__AF	BOX HBF 125 T4 22kW (A3:4) F400	1465	40,5	22	112.000	72	460	1
27309638__AF	BOX HBF 125 T4 22kW (A3:8) F400	1465	40,5	22	91.200	82	466	1
27310634__AF	BOX HBF 125 T4 30kW (A3:4) F400	1470	56,2	30	121.000	72	520	1
27310638__AF	BOX HBF 125 T4 30kW (A3:8) F400	1470	56,2	30	111.000	78	526	1
27311638__AF	BOX HBF 125 T4 37kW (A3:8) F400	1475	66,6	37	124.000	75	566	1
27312638__AF	BOX HBF 125 T4 45kW (A3:8) F400	1475	80,7	45	135.000	74	591	1

### Three-phase motor / 6 poles

Code	Model	R.P.M.	Rated I. (A) 400V	Rated power kW	Max. Airflow m3/h	Sound db (A)*	Weight	Connect. diagram
26351606__AF	BOX HBF 50 T6 0,75kW (A5:6) F400	923	2,2	0,75	6.000	40	74	1
26358656__AF	BOX HBF 56 T6 0,75kW (A5:6) F400	923	2,2	0,75	8.330	45	54	1
26364656__AF	BOX HBF 63 T6 0,75kW (A5:6) F400	923	2,2	0,75	11.450	47	57	1
26372656__AF	BOX HBF 71 T6 0,75kW (A5:6) F400	923	2,2	0,75	15.440	50	64	1
26380656__AF	BOX HBF 80 T6 0,75kW (A5:6) F400	923	2,2	0,75	17.380	56	76	1
26381656__AF	BOX HBF 80 T6 1,1kW (A5:6) F400	920	3,1	1,10	19.520	52	80	1
26382656__AF	BOX HBF 80 T6 1,5kW (A5:6) F400	933	3,6	1,50	21.820	52	86	1
26383656__AF	BOX HBF 80 T6 2,2kW (A5:6) F400	948	5,23	2,20	23.930	53	95	1
26391634__AF	BOX HBF 90 T6 1,5kW (A3:4) F400	940	3,6	1,50	25.600	51	97	1
26391638__AF	BOX HBF 90 T6 1,5kW (A3:8) F400	940	3,6	1,50	20.700	57	100	1
26392634__AF	BOX HBF 90 T6 2,2kW (A3:4) F400	940	5,23	2,20	30.000	51	106	1
26392638__AF	BOX HBF 90 T6 2,2kW (A3:8) F400	940	5,23	2,20	25.700	55	110	1
26393638__AF	BOX HBF 90 T6 3kW (A3:8) F400	960	7,42	3	30.800	54	134	1
26394638__AF	BOX HBF 90 T6 4kW (A3:8) F400	960	8,97	4	34.100	54	140	1

Code	Model	R.P.M.	Rated I. (A) 400V	Rated power kW	Max. Airflow m3/h	Sound db (A)*	Weight	Connect. diagram
26310634__AF	BOX HBF 100 T6 1,5kW (A3:4) F400	940	3,6	1,50	29.600	59	111	1
26311634__AF	BOX HBF 100 T6 2,2kW (A3:4) F400	940	5,23	2,20	35.000	58	120	1
26311638__AF	BOX HBF 100 T6 2,2kW (A3:8) F400	940	5,23	2,20	27.600	67	125	1
26312634__AF	BOX HBF 100 T6 3kW (A3:4) F400	960	7,42	3	40.400	57	144	1
26312638__AF	BOX HBF 100 T6 3kW (A3:8) F400	960	7,42	3	34.000	63	148	1
26313634__AF	BOX HBF 100 T6 4kW (A3:4) F400	960	8,97	4	42.200	58	150	1
26313638__AF	BOX HBF 100 T6 4kW (A3:8) F400	960	8,97	4	41.200	60	154	1
26314638__AF	BOX HBF 100 T6 5,5kW (A3:8) F400	960	12,8	5,50	48.600	60	158	1
26320634__AF	BOX HBF 112 T6 2,2kW (A3:4) F400	940	5,23	2,20	41.000	61	247	1
26321634__AF	BOX HBF 112 T6 3kW (A3:4) F400	960	7,42	3	48.900	60	269	1
26321638__AF	BOX HBF 112 T6 3kW (A3:8) F400	960	7,42	3	37.300	69	275	1
26322634__AF	BOX HBF 112 T6 4kW (A3:4) F400	960	8,97	4	55.900	59	274	1
26322638__AF	BOX HBF 112 T6 4kW (A3:8) F400	960	8,97	4	46.900	66	274	1
26323634__AF	BOX HBF 112 T6 5,5kW (A3:4) F400	960	12,8	5,50	58.000	60	278	1
26323638__AF	BOX HBF 112 T6 5,5kW (A3:8) F400	960	12,8	5,50	56.600	63	284	1
26324638__AF	BOX HBF 112 T6 7,5kW (A3:8) F400	970	15	7,50	64.600	62	324	1
27302634__AF	BOX HBF 125 T6 3kW (A3:4) F400	960	7,42	3	51.700	69	297	1
27303634__AF	BOX HBF 125 T6 4kW (A3:4) F400	960	8,97	4	59.100	65	303	1
27304634__AF	BOX HBF 125 T6 5,5kW (A3:4) F400	960	12,8	5,50	69.400	62	307	1
27304638__AF	BOX HBF 125 T6 5,5kW (A3:8) F400	960	12,8	5,50	54.800	74	318	1
27305634__AF	BOX HBF 125 T6 7,5kW (A3:4) F400	970	15	7,50	78.400	62	351	1
27305638__AF	BOX HBF 125 T6 7,5kW (A3:8) F400	970	15	7,50	67.700	69	362	1
27306638__AF	BOX HBF 125 T6 11kW (A3:8) F400	970	22	11	83.800	65	382	1
27307638__AF	BOX HBF 125 T6 15kW (A3:8) F400	970	27,9	15	87.200	64	420	1

## 2 SPEED MOTOR / 4/8 poles

Code	Model	R.P.M.	Rated I. (A) 400V	Rated power kW	Max. Airflow m3/h	Sound db (A)*	Weight	Connect. diagram
26347606__AW	BOX HBF 45 T4/T8 0,8/0,2kW (A5:6) F400	1417	2/0,89	0.8/0.2	6.650	32	68	2
26350606__AW	BOX HBF 50 T4/T8 0,8/0,2kW (A5:6) F400	1417	2/0,89	0.8/0.2	8.760	34	78	2
26359656__AW	BOX HBF 56 T4/T8 0,8/0,2kW (A5:6) F400	1417	2/0,89	0.8/0.2	10.270	39	65	2
26360656__AW	BOX HBF 56 T4/T8 1,2/0,3kW (A5:6) F400	1397	2,92/1,29	1.2/0.3	11.890	37	67	2
26361656__AW	BOX HBF 56 T4/T8 1,6/0,4kW (A5:6) F400	1425	3,8/1,69	1.6/0.4	13.870	39	72	2
26365656__AW	BOX HBF 63 T4/T8 0,8/0,2kW (A5:6) F400	1417	2/0,89	0.8/0.2	11.420	42	69	2
26366656__AW	BOX HBF 63 T4/T8 1,2/0,3kW (A5:6) F400	1397	2,92/1,29	1.2/0.3	14.010	43	75	2
26367656__AW	BOX HBF 63 T4/T8 1,6/0,4kW (A5:6) F400	1425	3,8/1,69	1.6/0.4	15.780	39	80	2
26368656__AW	BOX HBF 63 T4/T8 2,2/0,37kW (A5:6) F400	1434	4,84/2	2.2/0.37	17.690	40	86	2

Code	Model	R.P.M.	Rated I. (A) 400V	Rated power kW	Max. Airflow m3/h	Sound db (A)*	Weight	Connect. diagram
26372656__AW	BOX HBF 71 T4/T8 0,8/0,2kW (A5:6) F400	1417	2/0,89	0.8/0.2	12.950	47	101	2
26373656__AW	BOX HBF 71 T4/T8 1,2/0,3kW (A5:6) F400	1397	2,92/1,29	1.2/0.3	15.960	46	103	2
26374656__AW	BOX HBF 71 T4/T8 1,6/0,4kW (A5:6) F400	1425	3,8/1,69	1.6/0.4	18.960	45	104	2
26375656__AW	BOX HBF 71 T4/T8 2,2/0,37kW (A5:6) F400	1434	4,84/2	2.2/0.37	22.040	43	108	2
26376656__AW	BOX HBF 71 T4/T8 3/0,55kW (A5:6) F400	1428	7,1/5,1	3/0.55	23.900	45	111	2
26384656__AW	BOX HBF 80 T4/T8 3/0,55kW (A5:6) F400	1428	7,1/5,1	3/0.55	28.540	45	123	2
26385656__AW	BOX HBF 80 T4/T8 4/0,75kW (A5:6) F400	1430	8,6/2,6	4/0.75	32.300	46	135	2
26393634__AW	BOX HBF 90 T4/T8 2,8/0,7kW (A3:4) F400	-	6/2,4	2.8/0.7	27.600	47	162	2
26394634__AW	BOX HBF 90 T4/T8 4/0,75kW (A3:4) F400	1430	8,6/2,6	4/0.75	32.700	46	189	2
26395634__AW	BOX HBF 90 T4/T8 5,5/1,1kW (A3:4) F400	1454	10,9/3,32	5.5/1.1	39.500	44	202	2
26395638__AW	BOX HBF 90 T4/T8 5,5/1,1kW (A3:8) F400	1454	10,9/3,32	5.5/1.1	29.400	52	191	2
26396634__AW	BOX HBF 90 T4/T8 7,5/1,5kW (A3:4) F400	1461	14,9/3,7	7.5/1.5	44.600	44	216	2
26396638__AW	BOX HBF 90 T4/T8 7,5/1,5kW (A3:8) F400	1461	14,9/3,7	7.5/1.5	37.100	50	205	2
26397634__AW	BOX HBF 90 T4/T8 11/3kW (A3:4) F400	1455	21,7/7	11/3	46.300	46	246	2
26397638__AW	BOX HBF 90 T4/T8 11/3kW (A3:8) F400	1455	21,7/7	11/3	47.600	47	232	2
26398638__AW	BOX HBF 90 T4/T8 14/3,5kW (A3:8) F400	1450	26,5/8,45	14/3.5	52.600	48	282	2
26314634__AW	BOX HBF 100 T4/T8 5,5/1,1kW (A3:4) F400	1454	10,9/3,32	5.5/1.1	45.600	53	188	2
26315634__AW	BOX HBF 100 T4/T8 7,5/1,5kW (A3:4) F400	1461	14,9/3,7	7.5/1.5	51.400	52	202	2
26315638__AW	BOX HBF 100 T4/T8 7,5/1,5kW (A3:8) F400	1461	14,9/3,7	7.5/1.5	39.400	62	205	2
26316634__AW	BOX HBF 100 T4/T8 11/3kW (A3:4) F400	1455	21,7/7	11/3	62.300	51	229	2
26316638__AW	BOX HBF 100 T4/T8 11/3kW (A3:8) F400	1455	21,7/7	11/3	52.500	57	232	2
26317634__AW	BOX HBF 100 T4/T8 14/3,5kW (A3:4) F400	1450	26,5/8,45	14/3.5	65.200	52	280	2
26317638__AW	BOX HBF 100 T4/T8 14/3,5kW (A3:8) F400	1450	26,5/8,45	14/3.5	59.700	55	280	2
26318638__AW	BOX HBF 100 T4/T8 17/4,3kW (A3:8) F400	1475	33,4/12,7	17/4.3	67.500	54	250	2
26319638__AW	BOX HBF 100 T4/T8 20/5kW (A3:8) F400	1470	38,6/14,1	20/5	75.100	54	260	2
26323634__AW	BOX HBF 112 T4/T8 5,5/1,1kW (A3:4) F400	1454	10,9/3,32	5.5/1.1	50.600	56	235	2
26324634__AW	BOX HBF 112 T4/T8 7,5/1,5kW (A3:4) F400	1461	14,9/3,7	7.5/1.5	59.100	56	322	2
26325634__AW	BOX HBF 112 T4/T8 11/3kW (A3:4) F400	1455	21,7/7	11/3	75.500	53	346	2
26325638__AW	BOX HBF 112 T4/T8 11/3kW (A3:8) F400	1455	21,7/7	11/3	52.700	64	350	2
26326634__AW	BOX HBF 112 T4/T8 14/3,5kW (A3:4) F400	1450	26,5/8,45	14/3.5	82.900	53	340	2
26326638__AW	BOX HBF 112 T4/T8 14/3,5kW (A3:8) F400	1450	26,5/8,45	14/3.5	67.500	61	345	2
26326634__AW	BOX HBF 112 T4/T8 17/4,3kW (A3:4) F400	1475	33,4/12,7	17/4.3	89.500	53	351	2
26326638__AW	BOX HBF 112 T4/T8 17/4,3kW (A3:8) F400	1475	33,4/12,7	17/4.3	77.400	59	353	2
26328638__AW	BOX HBF 112 T4/T8 20/5kW (A3:8) F400	1470	38,6/14,1	20/5	82.400	58	373	2
26328638__AW	BOX HBF 112 T4/T8 28/6,5kW (A3:8) F400	1480	52/18	28/6.5	99.700	56	416	2
27306634__AW	BOX HBF 125 T4/T8 11/3kW (A3:4) F400	1455	21,7/7	11/3	74.100	64	383	2
27307634__AW	BOX HBF 125 T4/T8 14/3,5kW (A3:4) F400	1450	26,5/8,45	14/3.5	85.500	61	390	2
27308634__AW	BOX HBF 125 T4/T8 17/4,3kW (A3:4) F400	1475	33,4/12,7	17/4.3	96.900	57	397	2
27309634__AW	BOX HBF 125 T4/T8 20/5kW (A3:4) F400	1470	38,6/14,1	20/5	107.000	56	411	2



Code	Model	R.P.M.	Rated I. (A) 400V	Rated power kW	Max. Airflow m3/h	Sound db (A)*	Weight	Connect. diagram
27308638__AW	BOX HBF 125 T4/T8 20/5kW (A3:8) F400	1470	38,6/14,1	20/5	84.500	68	415	2
27309634__AW	BOX HBF 125 T4/T8 28/6,5kW (A3:4) F400	1480	52/18	28/6.5	121.000	56	459	2
27310638__AW	BOX HBF 125 T4/T8 28/6,5kW (A3:8) F400	1480	52/18	28/6.5	105.000	63	465	2
27311638__AW	BOX HBF 125 T4/T8 37/9,2kW (A3:8) F400	1485	74,2/25,4	37/9.2	124.000	59	615	2
27312638__AW	BOX HBF 125 T4/T8 44/11kW (A3:8) F400	1480	80,2/27,2	44/11	135.000	58	673	2

**Notes:**  
 \* Total sound pressure level at the point of maximum flow measured in dB(A) in the suction measured in free field at a distance of 6m from the source

## Dimensions

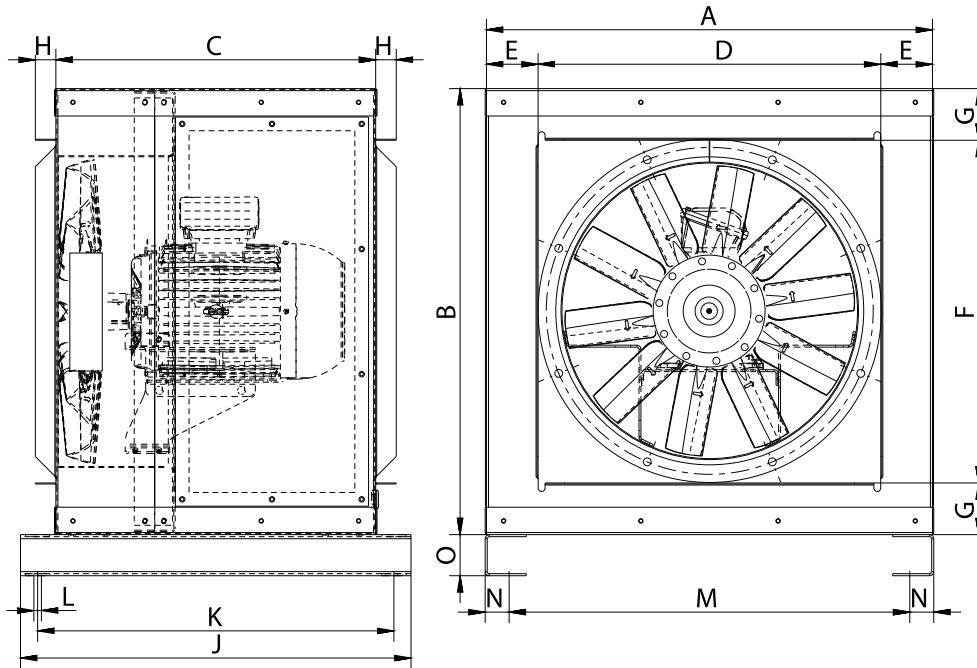

Model	A	B	C	D	E	F	G	H	J
BOX HBF 45 T4 0,75kW (A5:6) F400	651	651	467	500	75	500	75	30	570
BOX HBF 45 T4/T8 0,8/0,2kW (A5:6) F400	651	651	467	500	75	500	75	30	570
BOX HBF 50 T4 0,75kW (A5:6) F400	651	651	467	500	75	500	75	30	570
BOX HBF 50 T6 0,75kW (A5:6) F400	651	651	467	500	75	500	75	30	570
BOX HBF 50 T4/T8 0,8/0,2kW (A5:6) F400	651	651	467	500	75	500	75	30	570
BOX HBF 56 T4 0,75kW (A5:6) F400	781,5	781,5	542	630	76	630	76	30	665
BOX HBF 56 T4 1,1kW (A5:6) F400	781,5	781,5	542	630	76	630	76	30	665
BOX HBF 56 T4 1,5kW (A5:6) F400	781,5	781,5	542	630	76	630	76	30	665
BOX HBF 56 T6 0,75kW (A5:6) F400	781,5	781,5	542	630	76	630	76	30	665
BOX HBF 56 T4/T8 0,8/0,2kW (A5:6) F400	781,5	781,5	542	630	76	630	76	30	665
BOX HBF 56 T4/T8 1,2/0,3kW (A5:6) F400	781,5	781,5	542	630	76	630	76	30	665
BOX HBF 56 T4/T8 1,6/0,4kW (A5:6) F400	781,5	781,5	542	630	76	630	76	30	665
BOX HBF 63 T4 0,75kW (A5:6) F400	781,5	781,5	542	630	76	630	76	30	665
BOX HBF 63 T4 1,1kW (A5:6) F400	781,5	781,5	542	630	76	630	76	30	665
BOX HBF 63 T4 1,5kW (A5:6) F400	781,5	781,5	542	630	76	630	76	30	665
BOX HBF 63 T4 2,2kW (A5:6) F400	781,5	781,5	542	630	76	630	76	30	665
BOX HBF 63 T6 0,75kW (A5:6) F400	781,5	781,5	542	630	76	630	76	30	665



Model	A	B	C	D	E	F	G	H	J
BOX HBF 63 T4/T8 0,8/0,2kW (A5:6) F400	781,5	781,5	542	630	76	630	76	30	665
BOX HBF 63 T4/T8 1,2/0,3kW (A5:6) F400	781,5	781,5	542	630	76	630	76	30	665
BOX HBF 63 T4/T8 1,6/0,4kW (A5:6) F400	781,5	781,5	542	630	76	630	76	30	665
BOX HBF 63 T4/T8 2,2/0,37kW (A5:6) F400	781,5	781,5	542	630	76	630	76	30	665
BOX HBF 71 T4 0,75kW (A5:6) F400	951,5	951,5	597	800	76	800	76	30	70
BOX HBF 71 T4 1,1kW (A5:6) F400	951,5	951,5	597	800	76	800	76	30	70
BOX HBF 71 T4 1,5kW (A5:6) F400	951,5	951,5	597	800	76	800	76	30	70
BOX HBF 71 T4 2,2kW (A5:6) F400	951,5	951,5	597	800	76	800	76	30	70
BOX HBF 71 T4 3kW (A5:6) F400	951,5	951,5	597	800	76	800	76	30	70
BOX HBF 71 T6 0,75kW (A5:6) F400	951,5	951,5	597	800	76	800	76	30	70
BOX HBF 71 T4/T8 0,8/0,2kW (A5:6) F400	951,5	951,5	597	800	76	800	76	30	70
BOX HBF 71 T4/T8 1,2/0,3kW (A5:6) F400	951,5	951,5	597	800	76	800	76	30	70
BOX HBF 71 T4/T8 1,6/0,4kW (A5:6) F400	951,5	951,5	597	800	76	800	76	30	70
BOX HBF 71 T4/T8 2,2/0,37kW (A5:6) F400	951,5	951,5	597	800	76	800	76	30	70
BOX HBF 71 T4/T8 3/0,55kW (A5:6) F400	951,5	951,5	597	800	76	800	76	30	70
BOX HBF 80 T4 3kW (A5:6) F400	951,5	951,5	597	800	76	800	76	30	70
BOX HBF 80 T4 4kW (A5:6) F400	951,5	951,5	597	800	76	800	76	30	70
BOX HBF 80 T6 0,75kW (A5:6) F400	951,5	951,5	597	800	76	800	76	30	70
BOX HBF 80 T6 1,1kW (A5:6) F400	951,5	951,5	597	800	76	800	76	30	70
BOX HBF 80 T6 1,5kW (A5:6) F400	951,5	951,5	597	800	76	800	76	30	70
BOX HBF 80 T6 2,2kW (A5:6) F400	951,5	951,5	597	800	76	800	76	30	70
BOX HBF 80 T4/T8 3/0,55kW (A5:6) F400	951,5	951,5	597	800	76	800	76	30	70
BOX HBF 80 T4/T8 4/0,75kW (A5:6) F400	951,5	951,5	597	800	76	800	76	30	70
BOX HBF 90 T4 3kW (A3:4) F400	1176,5	1176,5	857	1000	88	1000	88	30	965
BOX HBF 90 T4 4kW (A3:4) F400	1176,5	1176,5	857	1000	88	1000	88	30	965
BOX HBF 90 T4 5,5kW (A3:4) F400	1176,5	1176,5	857	1000	88	1000	88	30	965
BOX HBF 90 T4 5,5kW (A3:8) F400	1176,5	1176,5	857	1000	88	1000	88	30	965
BOX HBF 90 T4 7,5kW (A3:4) F400	1176,5	1176,5	857	1000	88	1000	88	30	965
BOX HBF 90 T4 7,5kW (A3:8) F400	1176,5	1176,5	857	1000	88	1000	88	30	965
BOX HBF 90 T4 11kW (A3:4) F400	1176,5	1176,5	857	1000	88	1000	88	30	965
BOX HBF 90 T4 11kW (A3:8) F400	1176,5	1176,5	857	1000	88	1000	88	30	965
BOX HBF 90 T4 15kW (A3:8) F400	1176,5	1176,5	857	1000	88	1000	88	30	965
BOX HBF 90 T6 1,5kW (A3:4) F400	1176,5	1176,5	857	1000	88	1000	88	30	965
BOX HBF 90 T6 1,5kW (A3:8) F400	1176,5	1176,5	857	1000	88	1000	88	30	965
BOX HBF 90 T6 2,2kW (A3:4) F400	1176,5	1176,5	857	1000	88	1000	88	30	965



Model	A	B	C	D	E	F	G	H	J
BOX HBF 90 T6 2,2kW (A3:8) F400	1176,5	1176,5	857	1000	88	1000	88	30	965
BOX HBF 90 T6 3kW (A3:8) F400	1176,5	1176,5	857	1000	88	1000	88	30	965
BOX HBF 90 T6 4kW (A3:8) F400	1176,5	1176,5	857	1000	88	1000	88	30	965
BOX HBF 90 T4/T8 2,8/0,7kW (A3:4) F400	1176,5	1176,5	857	1000	88	1000	88	30	965
BOX HBF 90 T4/T8 4/0,75kW (A3:4) F400	1176,5	1176,5	857	1000	88	1000	88	30	965
BOX HBF 90 T4/T8 5,5/1,1kW (A3:4) F400	1176,5	1176,5	857	1000	88	1000	88	30	965
BOX HBF 90 T4/T8 5,5/1,1kW (A3:8) F400	1176,5	1176,5	857	1000	88	1000	88	30	965
BOX HBF 90 T4/T8 7,5/1,5kW (A3:4) F400	1176,5	1176,5	857	1000	88	1000	88	30	965
BOX HBF 90 T4/T8 7,5/1,5kW (A3:8) F400	1176,5	1176,5	857	1000	88	1000	88	30	965
BOX HBF 90 T4/T8 11/3kW (A3:4) F400	1176,5	1176,5	857	1000	88	1000	88	30	965
BOX HBF 90 T4/T8 11/3kW (A3:8) F400	1176,5	1176,5	857	1000	88	1000	88	30	965
BOX HBF 90 T4/T8 14/3,5kW (A3:8) F400	1176,5	1176,5	857	1000	88	1000	88	30	965
BOX HBF 100 T4 5,5kW (A3:4) F400	1176,5	1176,5	857	1000	88	1000	88	30	965
BOX HBF 100 T4 7,5kW (A3:4) F400	1176,5	1176,5	857	1000	88	1000	88	30	965
BOX HBF 100 T4 7,5kW (A3:8) F400	1176,5	1176,5	857	1000	88	1000	88	30	965
BOX HBF 100 T4 11kW (A3:4) F400	1176,5	1176,5	857	1000	88	1000	88	30	965
BOX HBF 100 T4 11kW (A3:8) F400	1176,5	1176,5	857	1000	88	1000	88	30	965
BOX HBF 100 T4 15kW (A3:4) F400	1176,5	1176,5	857	1000	88	1000	88	30	965
BOX HBF 100 T4 15kW (A3:8) F400	1176,5	1176,5	857	1000	88	1000	88	30	965
BOX HBF 100 T4 18,5kW (A3:8) F400	1176,5	1176,5	857	1000	88	1000	88	30	965
BOX HBF 100 T4 22kW (A3:8) F400	1176,5	1176,5	857	1000	88	1000	88	30	965
BOX HBF 100 T6 1,5kW (A3:4) F400	1176,5	1176,5	857	1000	88	1000	88	30	965
BOX HBF 100 T6 2,2kW (A3:4) F400	1176,5	1176,5	857	1000	88	1000	88	30	965
BOX HBF 100 T6 2,2kW (A3:8) F400	1176,5	1176,5	857	1000	88	1000	88	30	965
BOX HBF 100 T6 3kW (A3:4) F400	1176,5	1176,5	857	1000	88	1000	88	30	965
BOX HBF 100 T6 3kW (A3:8) F400	1176,5	1176,5	857	1000	88	1000	88	30	965
BOX HBF 100 T6 4kW (A3:4) F400	1176,5	1176,5	857	1000	88	1000	88	30	965
BOX HBF 100 T6 4kW (A3:8) F400	1176,5	1176,5	857	1000	88	1000	88	30	965
BOX HBF 100 T6 5,5kW (A3:8) F400	1176,5	1176,5	857	1000	88	1000	88	30	965
BOX HBF 100 T4/T8 5,5/1,1kW (A3:4) F400	1176,5	1176,5	857	1000	88	1000	88	30	965
BOX HBF 100 T4/T8 7,5/1,5kW (A3:4) F400	1176,5	1176,5	857	1000	88	1000	88	30	965
BOX HBF 100 T4/T8 7,5/1,5kW (A3:8) F400	1176,5	1176,5	857	1000	88	1000	88	30	965
BOX HBF 100 T4/T8 11/3kW (A3:4) F400	1176,5	1176,5	857	1000	88	1000	88	30	965
BOX HBF 100 T4/T8 11/3kW (A3:8) F400	1176,5	1176,5	857	1000	88	1000	88	30	965

Model	A	B	C	D	E	F	G	H	J
BOX HBF 100 T4/T8 14/3,5kW (A3:4) F400	1176,5	1176,5	857	1000	88	1000	88	30	965
BOX HBF 100 T4/T8 14/3,5kW (A3:8) F400	1176,5	1176,5	857	1000	88	1000	88	30	965
BOX HBF 100 T4/T8 17/4,3kW (A3:8) F400	1176,5	1176,5	857	1000	88	1000	88	30	965
BOX HBF 100 T4/T8 20/5kW (A3:8) F400	1176,5	1176,5	857	1000	88	1000	88	30	965
BOX HBF 112 T4 5,5kW (A3:4) F400	1416,5	1416,5	1019	1250	83	1250	83	30	1125
BOX HBF 112 T4 7,5kW (A3:4) F400	1416,5	1416,5	1019	1250	83	1250	83	30	1125
BOX HBF 112 T4 11kW (A3:4) F400	1416,5	1416,5	1019	1250	83	1250	83	30	1125
BOX HBF 112 T4 11kW (A3:8) F400	1416,5	1416,5	1019	1250	83	1250	83	30	1125
BOX HBF 112 T4 15kW (A3:4) F400	1416,5	1416,5	1019	1250	83	1250	83	30	1125
BOX HBF 112 T4 15kW (A3:8) F400	1416,5	1416,5	1019	1250	83	1250	83	30	1125
BOX HBF 112 T4 18,5kW (A3:4) F400	1416,5	1416,5	1019	1250	83	1250	83	30	1125
BOX HBF 112 T4 18,5kW (A3:8) F400	1416,5	1416,5	1019	1250	83	1250	83	30	1125
BOX HBF 112 T4 22kW (A3:8) F400	1416,5	1416,5	1019	1250	83	1250	83	30	1125
BOX HBF 112 T4 30kW (A3:8) F400	1416,5	1416,5	1019	1250	83	1250	83	30	1125
BOX HBF 112 T6 2,2kW (A3:4) F400	1416,5	1416,5	1019	1250	83	1250	83	30	1125
BOX HBF 112 T6 3kW (A3:4) F400	1416,5	1416,5	1019	1250	83	1250	83	30	1125
BOX HBF 112 T6 3kW (A3:8) F400	1416,5	1416,5	1019	1250	83	1250	83	30	1125
BOX HBF 112 T6 4kW (A3:4) F400	1416,5	1416,5	1019	1250	83	1250	83	30	1125
BOX HBF 112 T6 4kW (A3:8) F400	1416,5	1416,5	1019	1250	83	1250	83	30	1125
BOX HBF 112 T6 5,5kW (A3:4) F400	1416,5	1416,5	1019	1250	83	1250	83	30	1125
BOX HBF 112 T6 5,5kW (A3:8) F400	1416,5	1416,5	1019	1250	83	1250	83	30	1125
BOX HBF 112 T6 7,5kW (A3:8) F400	1416,5	1416,5	1019	1250	83	1250	83	30	1125
BOX HBF 112 T4/T8 5,5/1,1kW (A3:4) F400	1416,5	1416,5	1019	1250	83	1250	83	30	1125
BOX HBF 112 T4/T8 7,5/1,5kW (A3:4) F400	1416,5	1416,5	1019	1250	83	1250	83	30	1125
BOX HBF 112 T4/T8 11/3kW (A3:4) F400	1416,5	1416,5	1019	1250	83	1250	83	30	1125
BOX HBF 112 T4/T8 11/3kW (A3:8) F400	1416,5	1416,5	1019	1250	83	1250	83	30	1125
BOX HBF 112 T4/T8 14/3,5kW (A3:4) F400	1416,5	1416,5	1019	1250	83	1250	83	30	1125
BOX HBF 112 T4/T8 14/3,5kW (A3:8) F400	1416,5	1416,5	1019	1250	83	1250	83	30	1125
BOX HBF 112 T4/T8 17/4,3kW (A3:4) F400	1416,5	1416,5	1019	1250	83	1250	83	30	1125
BOX HBF 112 T4/T8 17/4,3kW (A3:8) F400	1416,5	1416,5	1019	1250	83	1250	83	30	1125
BOX HBF 112 T4/T8 20/5kW (A3:8) F400	1416,5	1416,5	1019	1250	83	1250	83	30	1125
BOX HBF 112 T4/T8 28/6,5kW (A3:8) F400	1416,5	1416,5	1019	1250	83	1250	83	30	1125
BOX HBF 125 T4 11kW (A3:4) F400	1416,5	1416,5	1019	1250	83	1250	83	30	1125

Model	A	B	C	D	E	F	G	H	J
BOX HBF 125 T4 15kW (A3:4) F400	1416,5	1416,5	1019	1250	83	1250	83	30	1125
BOX HBF 125 T4 18,5kW (A3:4) F400	1416,5	1416,5	1019	1250	83	1250	83	30	1125
BOX HBF 125 T4 18,5kW (A3:8) F400	1416,5	1416,5	1019	1250	83	1250	83	30	1125
BOX HBF 125 T4 22kW (A3:4) F400	1416,5	1416,5	1019	1250	83	1250	83	30	1125
BOX HBF 125 T4 22kW (A3:8) F400	1416,5	1416,5	1019	1250	83	1250	83	30	1125
BOX HBF 125 T4 30kW (A3:4) F400	1416,5	1416,5	1019	1250	83	1250	83	30	1125
BOX HBF 125 T4 30kW (A3:8) F400	1416,5	1416,5	1019	1250	83	1250	83	30	1125
BOX HBF 125 T4 37kW (A3:8) F400	1416,5	1416,5	1019	1250	83	1250	83	30	1125
BOX HBF 125 T4 45kW (A3:8) F400	1416,5	1416,5	1019	1250	83	1250	83	30	1125
BOX HBF 125 T6 3kW (A3:4) F400	1416,5	1416,5	1019	1250	83	1250	83	30	1125
BOX HBF 125 T6 4kW (A3:4) F400	1416,5	1416,5	1019	1250	83	1250	83	30	1125
BOX HBF 125 T6 5,5kW (A3:4) F400	1416,5	1416,5	1019	1250	83	1250	83	30	1125
BOX HBF 125 T6 5,5kW (A3:8) F400	1416,5	1416,5	1019	1250	83	1250	83	30	1125
BOX HBF 125 T6 7,5kW (A3:4) F400	1416,5	1416,5	1019	1250	83	1250	83	30	1125
BOX HBF 125 T6 7,5kW (A3:8) F400	1416,5	1416,5	1019	1250	83	1250	83	30	1125
BOX HBF 125 T6 11kW (A3:8) F400	1416,5	1416,5	1019	1250	83	1250	83	30	1125
BOX HBF 125 T6 15kW (A3:8) F400	1416,5	1416,5	1019	1250	83	1250	83	30	1125
BOX HBF 125 T4/T8 11/3kW (A3:4) F400	1416,5	1416,5	1019	1250	83	1250	83	30	1125
BOX HBF 125 T4/T8 14/3,5kW (A3:4) F400	1416,5	1416,5	1019	1250	83	1250	83	30	1125
BOX HBF 125 T4/T8 17/4,3kW (A3:4) F400	1416,5	1416,5	1019	1250	83	1250	83	30	1125
BOX HBF 125 T4/T8 20/5kW (A3:4) F400	1416,5	1416,5	1019	1250	83	1250	83	30	1125
BOX HBF 125 T4/T8 20/5kW (A3:8) F400	1416,5	1416,5	1019	1250	83	1250	83	30	1125
BOX HBF 125 T4/T8 28/6,5kW (A3:4) F400	1416,5	1416,5	1019	1250	83	1250	83	30	1125
BOX HBF 125 T4/T8 28/6,5kW (A3:8) F400	1416,5	1416,5	1019	1250	83	1250	83	30	1125
BOX HBF 125 T4/T8 37/9,2kW (A3:8) F400	1416,5	1416,5	1019	1250	83	1250	83	30	1125
BOX HBF 125 T4/T8 44/11kW (A3:8) F400	1416,5	1416,5	1019	1250	83	1250	83	30	1125

Model	K	L	M	N	O
BOX HBF 45 T4 0,75kW (A5:6) F400	520	11	585	35	60
BOX HBF 45 T4/T8 0,8/0,2kW (A5:6) F400	520	11	585	35	60
BOX HBF 50 T4 0,75kW (A5:6) F400	520	11	585	35	60
BOX HBF 50 T6 0,75kW (A5:6) F400	520	11	585	35	60
BOX HBF 50 T4/T8 0,8/0,2kW (A5:6) F400	520	11	585	35	60
BOX HBF 56 T4 0,75kW (A5:6) F400	610	11	715	35	60
BOX HBF 56 T4 1,1kW (A5:6) F400	610	11	715	35	60



Model	K	L	M	N	O
BOX HBF 56 T4 1,5kW (A5:6) F400	610	11	715	35	60
BOX HBF 56 T6 0,75kW (A5:6) F400	610	11	715	35	60
BOX HBF 56 T4/T8 0,8/0,2kW (A5:6) F400	610	11	715	35	60
BOX HBF 56 T4/T8 1,2/0,3kW (A5:6) F400	610	11	715	35	60
BOX HBF 56 T4/T8 1,6/0,4kW (A5:6) F400	610	11	715	35	60
BOX HBF 63 T4 0,75kW (A5:6) F400	610	11	715	35	60
BOX HBF 63 T4 1,1kW (A5:6) F400	610	11	715	35	60
BOX HBF 63 T4 1,5kW (A5:6) F400	610	11	715	35	60
BOX HBF 63 T4 2,2kW (A5:6) F400	610	11	715	35	60
BOX HBF 63 T6 0,75kW (A5:6) F400	610	11	715	35	60
BOX HBF 63 T4/T8 0,8/0,2kW (A5:6) F400	610	11	715	35	60
BOX HBF 63 T4/T8 1,2/0,3kW (A5:6) F400	610	11	715	35	60
BOX HBF 63 T4/T8 1,6/0,4kW (A5:6) F400	610	11	715	35	60
BOX HBF 63 T4/T8 2,2/0,37kW (A5:6) F400	610	11	715	35	60
BOX HBF 71 T4 0,75kW (A5:6) F400	650	11	885	35	60
BOX HBF 71 T4 1,1kW (A5:6) F400	650	11	885	35	60
BOX HBF 71 T4 1,5kW (A5:6) F400	650	11	885	35	60
BOX HBF 71 T4 2,2kW (A5:6) F400	650	11	885	35	60
BOX HBF 71 T4 3kW (A5:6) F400	650	11	885	35	60
BOX HBF 71 T6 0,75kW (A5:6) F400	650	11	885	35	60
BOX HBF 71 T4/T8 0,8/0,2kW (A5:6) F400	650	11	885	35	60
BOX HBF 71 T4/T8 1,2/0,3kW (A5:6) F400	650	11	885	35	60
BOX HBF 71 T4/T8 1,6/0,4kW (A5:6) F400	650	11	885	35	60
BOX HBF 71 T4/T8 2,2/0,37kW (A5:6) F400	650	11	885	35	60
BOX HBF 71 T4/T8 3/0,55kW (A5:6) F400	650	11	885	35	60
BOX HBF 80 T4 3kW (A5:6) F400	650	11	885	35	60
BOX HBF 80 T4 4kW (A5:6) F400	650	11	885	35	60
BOX HBF 80 T6 0,75kW (A5:6) F400	650	11	885	35	60
BOX HBF 80 T6 1,1kW (A5:6) F400	650	11	885	35	60
BOX HBF 80 T6 1,5kW (A5:6) F400	650	11	885	35	60
BOX HBF 80 T6 2,2kW (A5:6) F400	650	11	885	35	60
BOX HBF 80 T4/T8 3/0,55kW (A5:6) F400	650	11	885	35	60

Model	K	L	M	N	O
BOX HBF 80 T4/T8 4/0,75kW (A5:6) F400	650	11	885	35	60
BOX HBF 90 T4 3kW (A3:4) F400	915	11	110	35	90
BOX HBF 90 T4 4kW (A3:4) F400	915	11	110	35	90
BOX HBF 90 T4 5,5kW (A3:4) F400	915	11	110	35	90
BOX HBF 90 T4 5,5kW (A3:8) F400	915	11	110	35	90
BOX HBF 90 T4 7,5kW (A3:4) F400	915	11	110	35	90
BOX HBF 90 T4 7,5kW (A3:8) F400	915	11	110	35	90
BOX HBF 90 T4 11kW (A3:4) F400	915	11	110	35	90
BOX HBF 90 T4 11kW (A3:8) F400	915	11	110	35	90
BOX HBF 90 T4 15kW (A3:8) F400	915	11	110	35	90
BOX HBF 90 T6 1,5kW (A3:4) F400	915	11	110	35	90
BOX HBF 90 T6 1,5kW (A3:8) F400	915	11	110	35	90
BOX HBF 90 T6 2,2kW (A3:4) F400	915	11	110	35	90
BOX HBF 90 T6 2,2kW (A3:8) F400	915	11	110	35	90
BOX HBF 90 T6 3kW (A3:8) F400	915	11	110	35	90
BOX HBF 90 T6 4kW (A3:8) F400	915	11	110	35	90
BOX HBF 90 T4/T8 2,8/0,7kW (A3:4) F400	915	11	110	35	90
BOX HBF 90 T4/T8 4/0,75kW (A3:4) F400	915	11	110	35	90
BOX HBF 90 T4/T8 5,5/1,1kW (A3:4) F400	915	11	110	35	90
BOX HBF 90 T4/T8 5,5/1,1kW (A3:8) F400	915	11	110	35	90
BOX HBF 90 T4/T8 7,5/1,5kW (A3:4) F400	915	11	110	35	90
BOX HBF 90 T4/T8 7,5/1,5kW (A3:8) F400	915	11	110	35	90
BOX HBF 90 T4/T8 11/3kW (A3:4) F400	915	11	110	35	90
BOX HBF 90 T4/T8 11/3kW (A3:8) F400	915	11	110	35	90
BOX HBF 90 T4/T8 14/3,5kW (A3:8) F400	915	11	110	35	90
BOX HBF 100 T4 5,5kW (A3:4) F400	915	11	110	35	90
BOX HBF 100 T4 7,5kW (A3:4) F400	915	11	110	35	90
BOX HBF 100 T4 7,5kW (A3:8) F400	915	11	110	35	90
BOX HBF 100 T4 11kW (A3:4) F400	915	11	110	35	90
BOX HBF 100 T4 11kW (A3:8) F400	915	11	110	35	90
BOX HBF 100 T4 15kW (A3:4) F400	915	11	110	35	90
BOX HBF 100 T4 15kW (A3:8) F400	915	11	110	35	90
BOX HBF 100 T4 18,5kW (A3:8) F400	915	11	110	35	90
BOX HBF 100 T4 22kW (A3:8) F400	915	11	110	35	90
BOX HBF 100 T6 1,5kW (A3:4) F400	915	11	110	35	90
BOX HBF 100 T6 2,2kW (A3:4) F400	915	11	110	35	90
BOX HBF 100 T6 2,2kW (A3:8) F400	915	11	110	35	90

Model	K	L	M	N	O
BOX HBF 100 T6 3kW (A3:4) F400	915	11	110	35	90
BOX HBF 100 T6 3kW (A3:8) F400	915	11	110	35	90
BOX HBF 100 T6 4kW (A3:4) F400	915	11	110	35	90
BOX HBF 100 T6 4kW (A3:8) F400	915	11	110	35	90
BOX HBF 100 T6 5,5kW (A3:8) F400	915	11	110	35	90
BOX HBF 100 T4/T8 5,5/1,1kW (A3:4) F400	915	11	110	35	90
BOX HBF 100 T4/T8 7,5/1,5kW (A3:4) F400	915	11	110	35	90
BOX HBF 100 T4/T8 7,5/1,5kW (A3:8) F400	915	11	110	35	90
BOX HBF 100 T4/T8 11/3kW (A3:4) F400	915	11	110	35	90
BOX HBF 100 T4/T8 11/3kW (A3:8) F400	915	11	110	35	90
BOX HBF 100 T4/T8 14/3,5kW (A3:4) F400	915	11	110	35	90
BOX HBF 100 T4/T8 14/3,5kW (A3:8) F400	915	11	110	35	90
BOX HBF 100 T4/T8 17/4,3kW (A3:8) F400	915	11	110	35	90
BOX HBF 100 T4/T8 20/5kW (A3:8) F400	915	11	110	35	90
BOX HBF 112 T4 5,5kW (A3:4) F400	1075	11	1350	35	90
BOX HBF 112 T4 7,5kW (A3:4) F400	1075	11	1350	35	90
BOX HBF 112 T4 11kW (A3:4) F400	1075	11	1350	35	90
BOX HBF 112 T4 11kW (A3:8) F400	1075	11	1350	35	90
BOX HBF 112 T4 15kW (A3:4) F400	1075	11	1350	35	90
BOX HBF 112 T4 15kW (A3:8) F400	1075	11	1350	35	90
BOX HBF 112 T4 18,5kW (A3:4) F400	1075	11	1350	35	90
BOX HBF 112 T4 18,5kW (A3:8) F400	1075	11	1350	35	90
BOX HBF 112 T4 22kW (A3:8) F400	1075	11	1350	35	90
BOX HBF 112 T4 30kW (A3:8) F400	1075	11	1350	35	90
BOX HBF 112 T6 2,2kW (A3:4) F400	1075	11	1350	35	90
BOX HBF 112 T6 3kW (A3:4) F400	1075	11	1350	35	90
BOX HBF 112 T6 3kW (A3:8) F400	1075	11	1350	35	90
BOX HBF 112 T6 4kW (A3:4) F400	1075	11	1350	35	90
BOX HBF 112 T6 4kW (A3:8) F400	1075	11	1350	35	90
BOX HBF 112 T6 5,5kW (A3:4) F400	1075	11	1350	35	90
BOX HBF 112 T6 5,5kW (A3:8) F400	1075	11	1350	35	90
BOX HBF 112 T6 7,5kW (A3:8) F400	1075	11	1350	35	90
BOX HBF 112 T4/T8 5,5/1,1kW (A3:4) F400	1075	11	1350	35	90
BOX HBF 112 T4/T8 7,5/1,5kW (A3:4) F400	1075	11	1350	35	90
BOX HBF 112 T4/T8 11/3kW (A3:4) F400	1075	11	1350	35	90

Model	K	L	M	N	O
BOX HBF 112 T4/T8 11/3kW (A3:8) F400	1075	11	1350	35	90
BOX HBF 112 T4/T8 14/3,5kW (A3:4) F400	1075	11	1350	35	90
BOX HBF 112 T4/T8 14/3,5kW (A3:8) F400	1075	11	1350	35	90
BOX HBF 112 T4/T8 17/4,3kW (A3:4) F400	1075	11	1350	35	90
BOX HBF 112 T4/T8 17/4,3kW (A3:8) F400	1075	11	1350	35	90
BOX HBF 112 T4/T8 20/5kW (A3:8) F400	1075	11	1350	35	90
BOX HBF 112 T4/T8 28/6,5kW (A3:8) F400	1075	11	1350	35	90
BOX HBF 125 T4 11kW (A3:4) F400	1075	11	1350	35	90
BOX HBF 125 T4 15kW (A3:4) F400	1075	11	1350	35	90
BOX HBF 125 T4 18,5kW (A3:4) F400	1075	11	1350	35	90
BOX HBF 125 T4 18,5kW (A3:8) F400	1075	11	1350	35	90
BOX HBF 125 T4 22kW (A3:4) F400	1075	11	1350	35	90
BOX HBF 125 T4 22kW (A3:8) F400	1075	11	1350	35	90
BOX HBF 125 T4 30kW (A3:4) F400	1075	11	1350	35	90
BOX HBF 125 T4 30kW (A3:8) F400	1075	11	1350	35	90
BOX HBF 125 T4 37kW (A3:8) F400	1075	11	1350	35	90
BOX HBF 125 T4 45kW (A3:8) F400	1075	11	1350	35	90
BOX HBF 125 T6 3kW (A3:4) F400	1075	11	1350	35	90
BOX HBF 125 T6 4kW (A3:4) F400	1075	11	1350	35	90
BOX HBF 125 T6 5,5kW (A3:4) F400	1075	11	1350	35	90
BOX HBF 125 T6 5,5kW (A3:8) F400	1075	11	1350	35	90
BOX HBF 125 T6 7,5kW (A3:4) F400	1075	11	1350	35	90
BOX HBF 125 T6 7,5kW (A3:8) F400	1075	11	1350	35	90
BOX HBF 125 T6 11kW (A3:8) F400	1075	11	1350	35	90
BOX HBF 125 T6 15kW (A3:8) F400	1075	11	1350	35	90
BOX HBF 125 T4/T8 11/3kW (A3:4) F400	1075	11	1350	35	90
BOX HBF 125 T4/T8 14/3,5kW (A3:4) F400	1075	11	1350	35	90
BOX HBF 125 T4/T8 17/4,3kW (A3:4) F400	1075	11	1350	35	90
BOX HBF 125 T4/T8 20/5kW (A3:4) F400	1075	11	1350	35	90
BOX HBF 125 T4/T8 20/5kW (A3:8) F400	1075	11	1350	35	90
BOX HBF 125 T4/T8 28/6,5kW (A3:4) F400	1075	11	1350	35	90
BOX HBF 125 T4/T8 28/6,5kW (A3:8) F400	1075	11	1350	35	90
BOX HBF 125 T4/T8 37/9,2kW (A3:8) F400	1075	11	1350	35	90





Model	K	L	M	N	O
BOX HBF 125 T4/T8 44/11kW (A3:8) F400	1075	11	1350	35	90

## Wiring diagram

DIAGRAM Nº 1

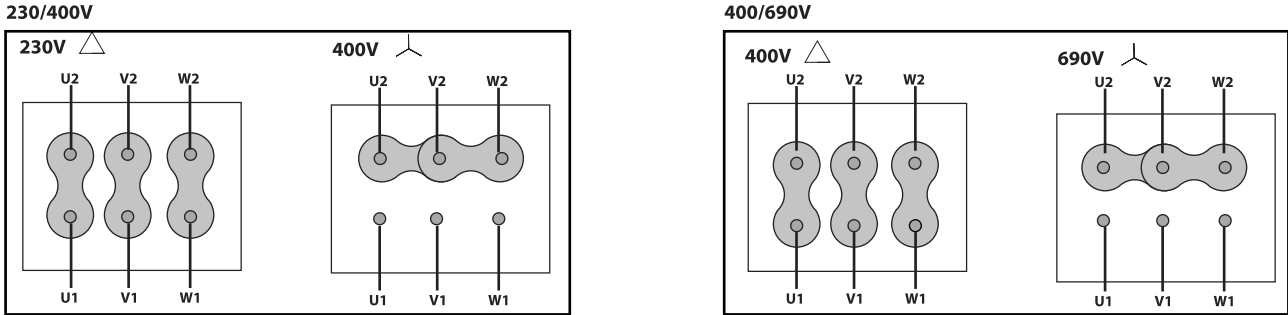
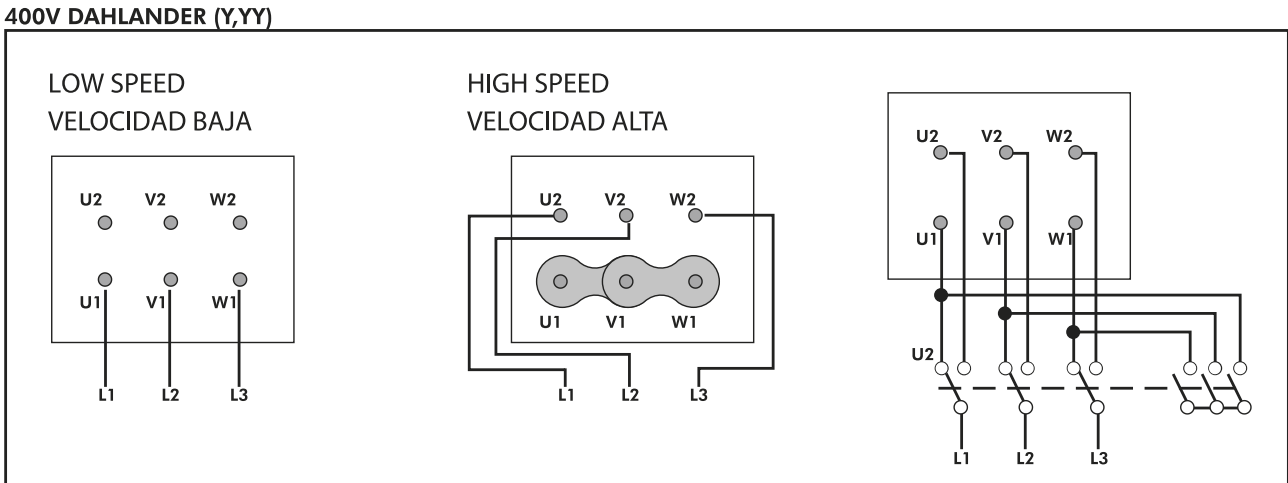

DIAGRAM Nº 2



# CHARACTERISCTIC CURVE

BOX HBF 45 T4 0,75kW (A5:6) F400

## AIR FLOW - PRESSURE

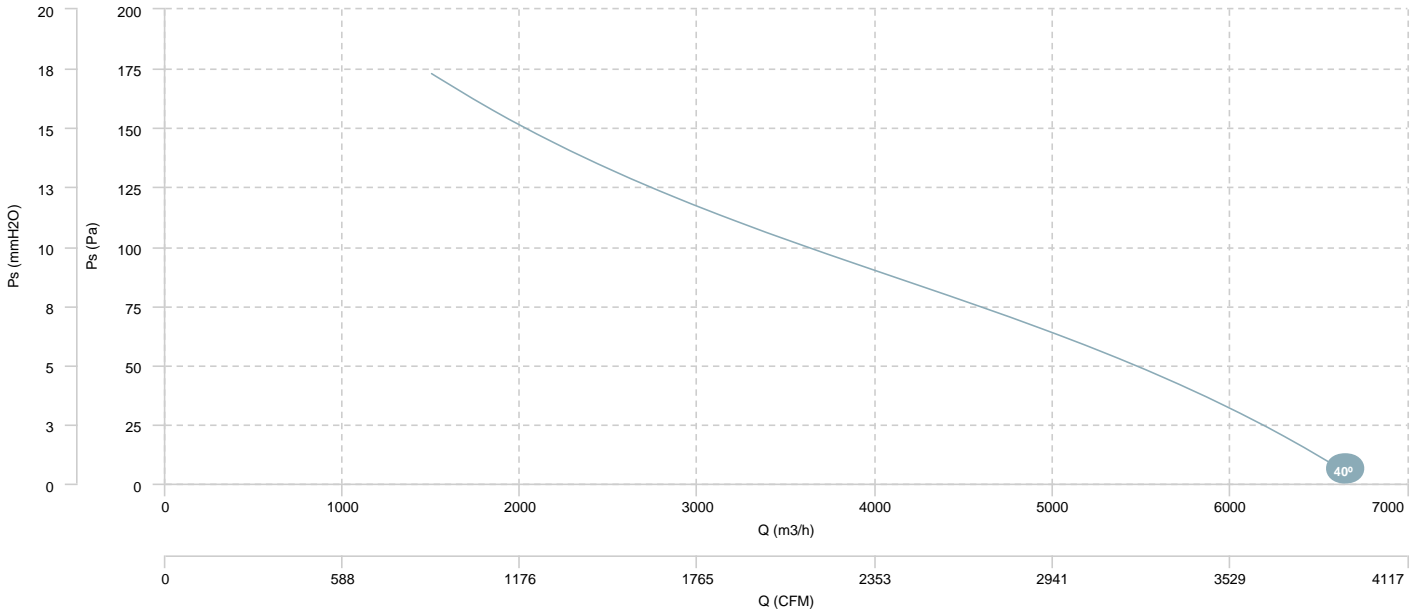

## AIR FLOW - ABSORBED POWER

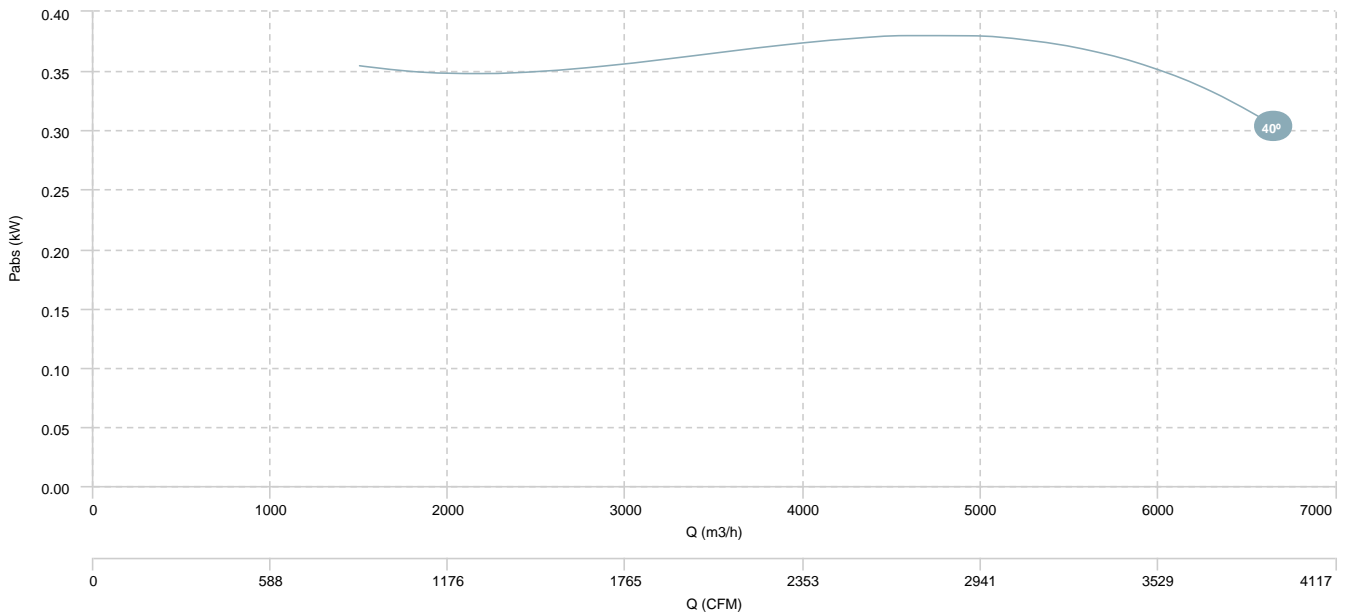

BOX HBF 45 T4/T8 0,8/0,2kW (A5:6)  
F400

**AIR FLOW - PRESSURE (4 poles)**

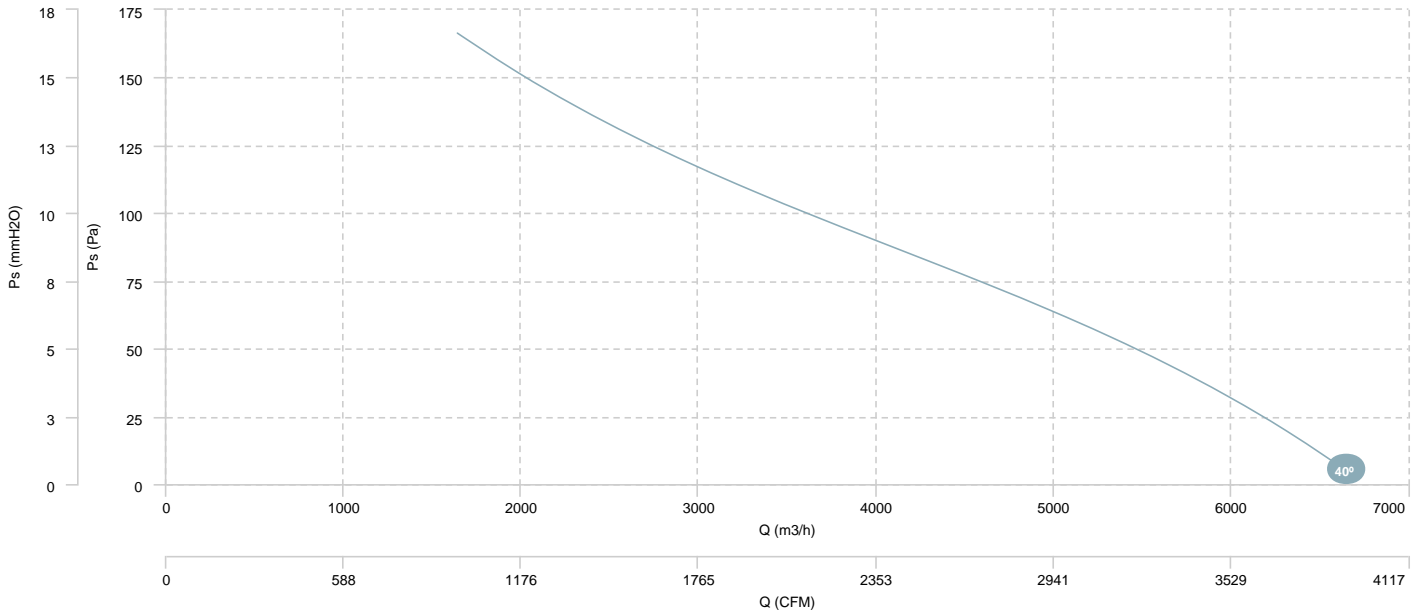

**AIR FLOW - ABSORBED POWER (4 poles)**

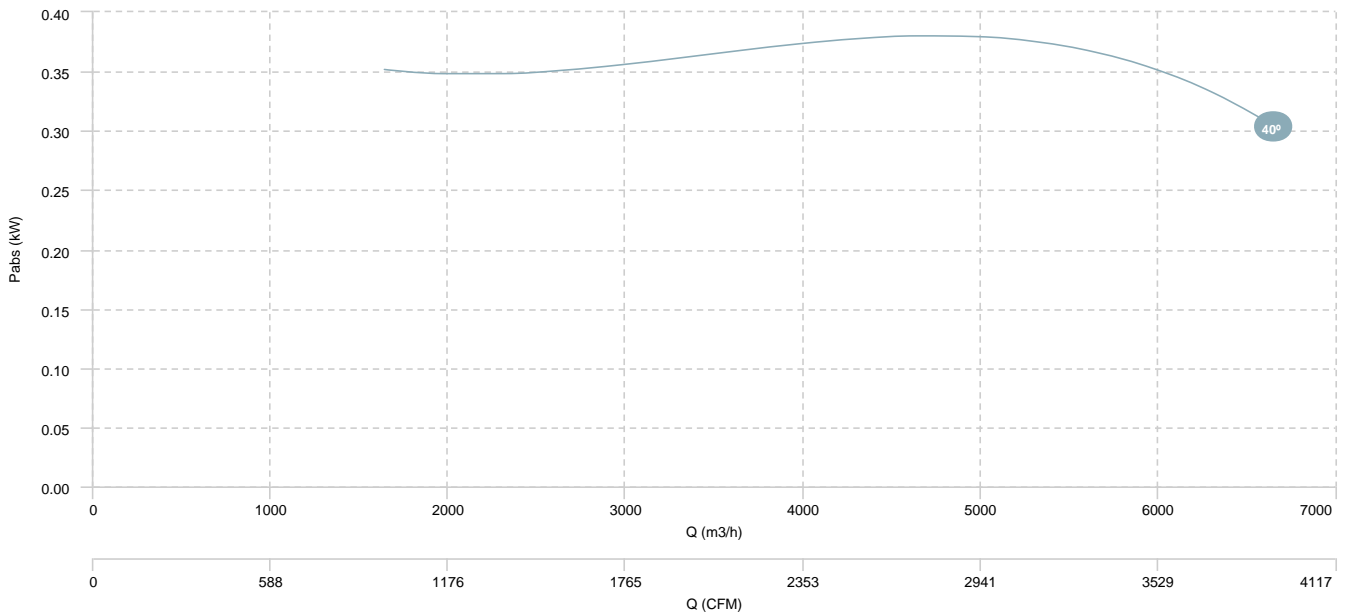

BOX HBF 45 T4/T8 0,8/0,2kW (A5:6)  
F400

AIR FLOW - PRESSURE (8 poles)

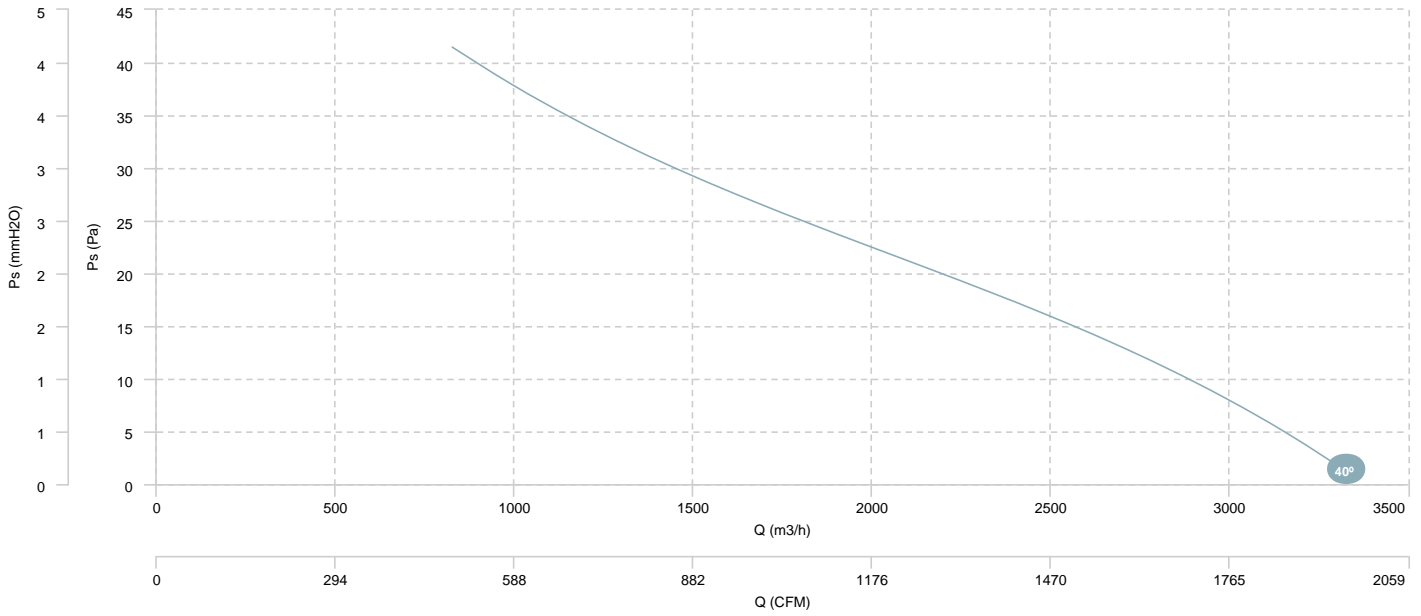

BOX HBF 50 T4 0,75kW (A5:6) F400

AIR FLOW - PRESSURE

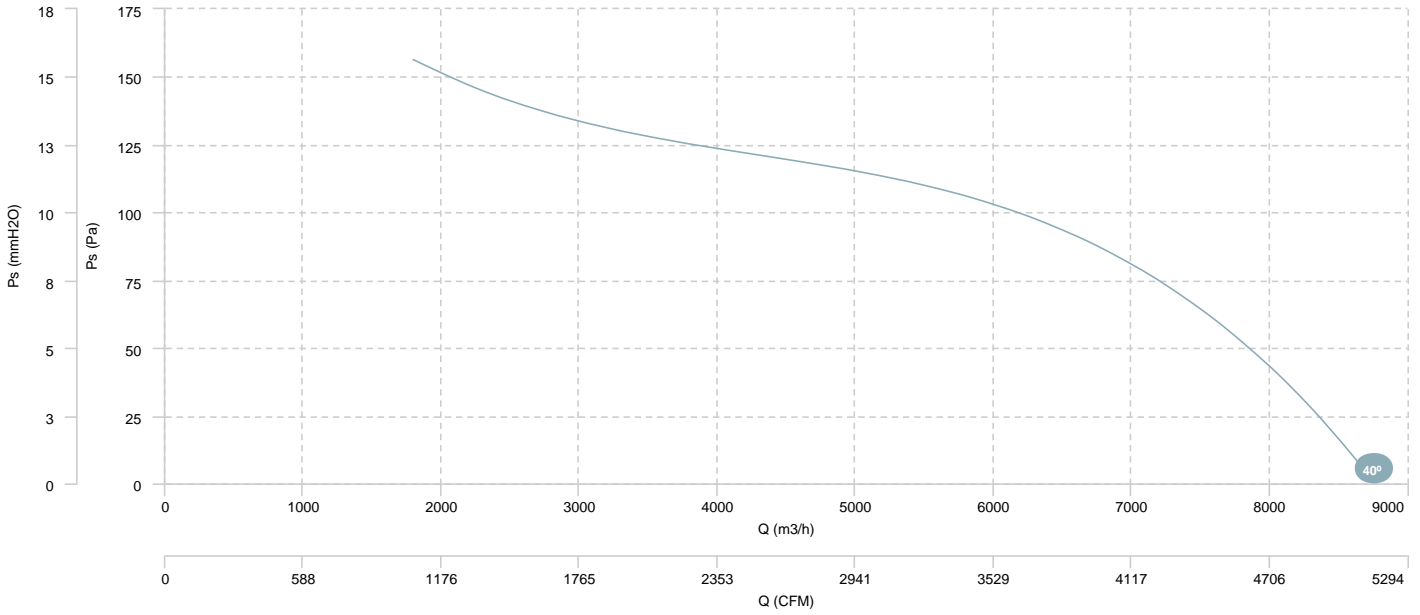

AIR FLOW - ABSORBED POWER

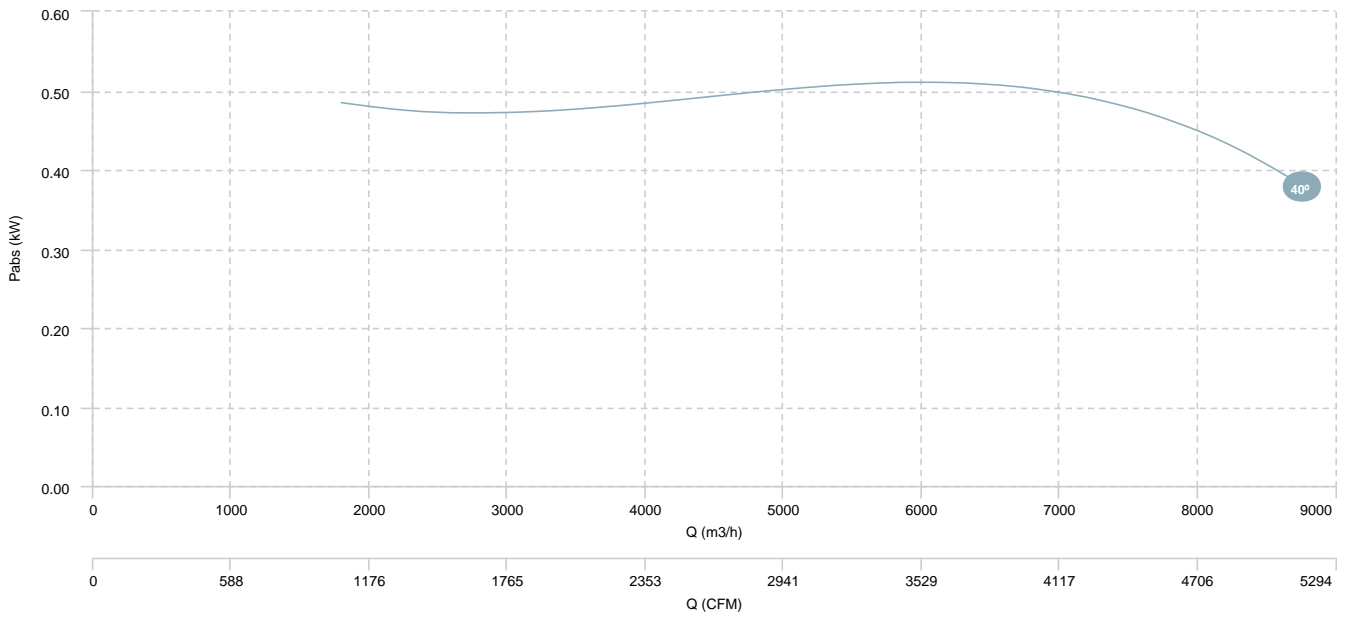

BOX HBF 50 T6 0,75kW (A5:6) F400

AIR FLOW - PRESSURE

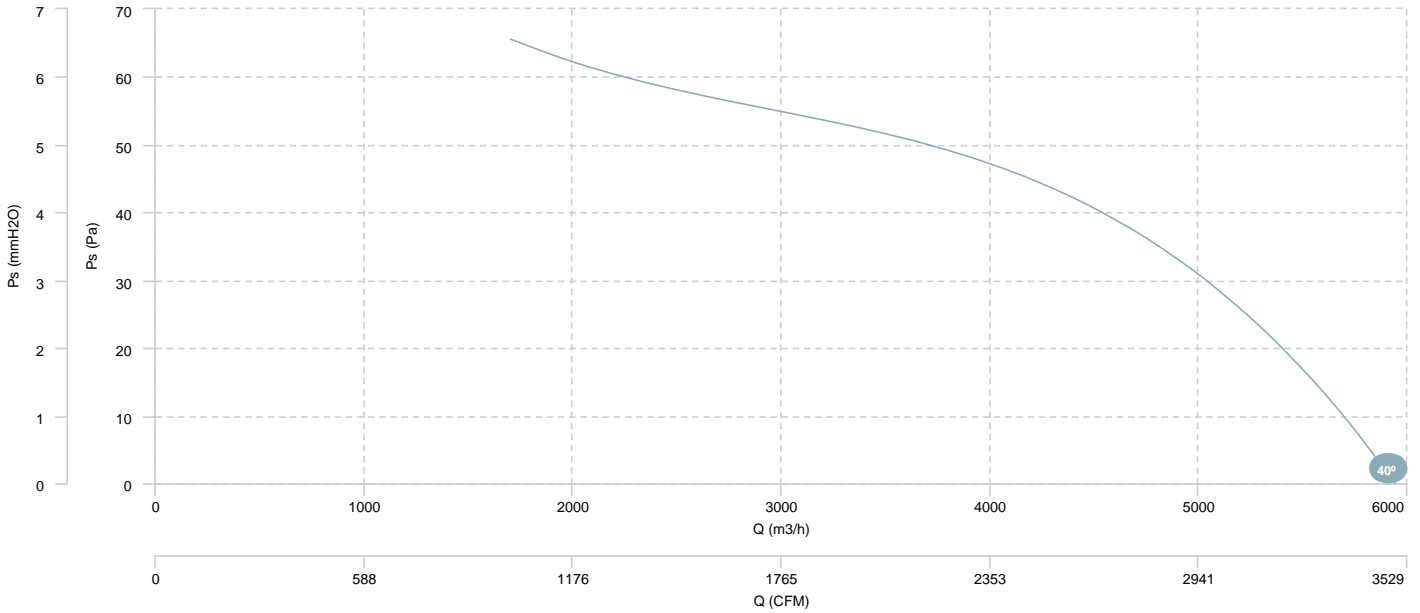

AIR FLOW - ABSORBED POWER

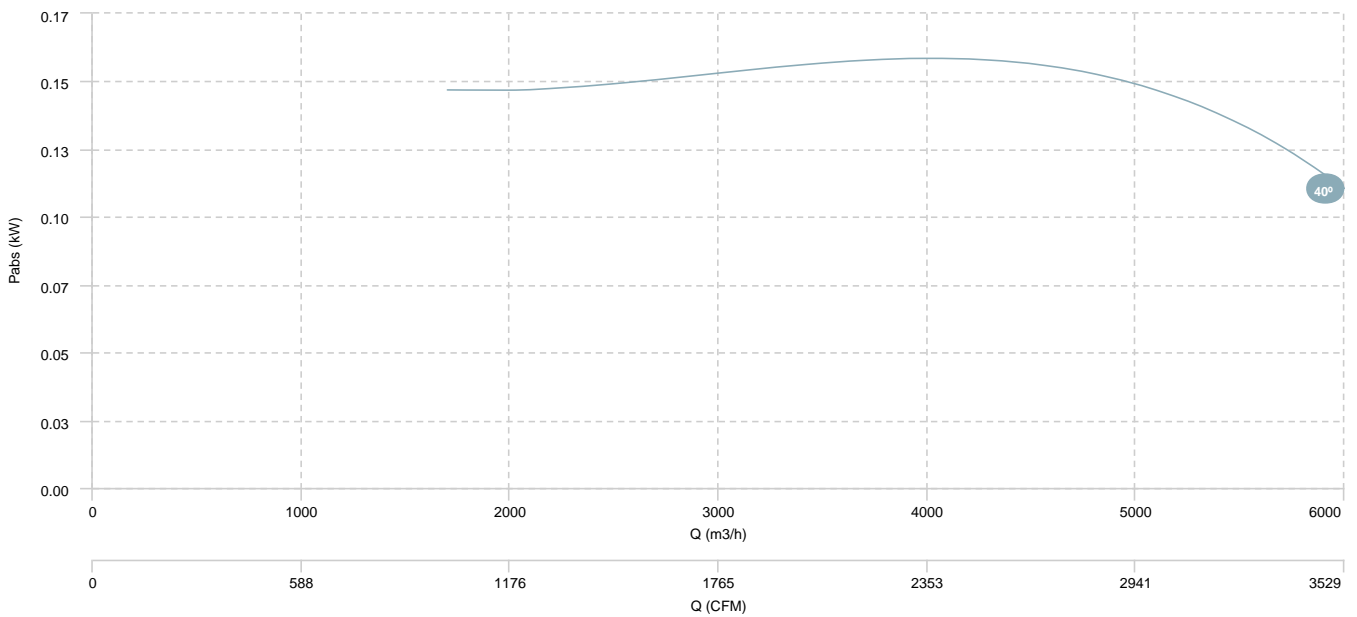



BOX HBF 50 T4/T8 0,8/0,2kW (A5:6)  
F400

**AIR FLOW - PRESSURE (4 poles)**

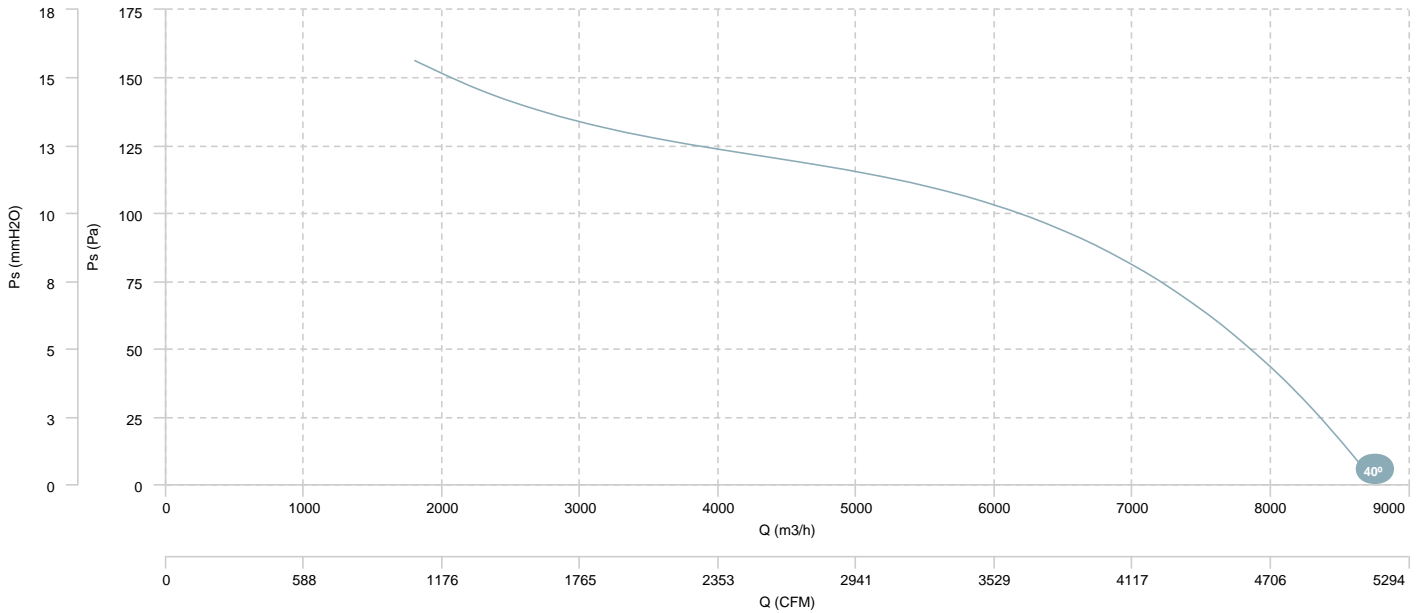

**AIR FLOW - ABSORBED POWER (4 poles)**

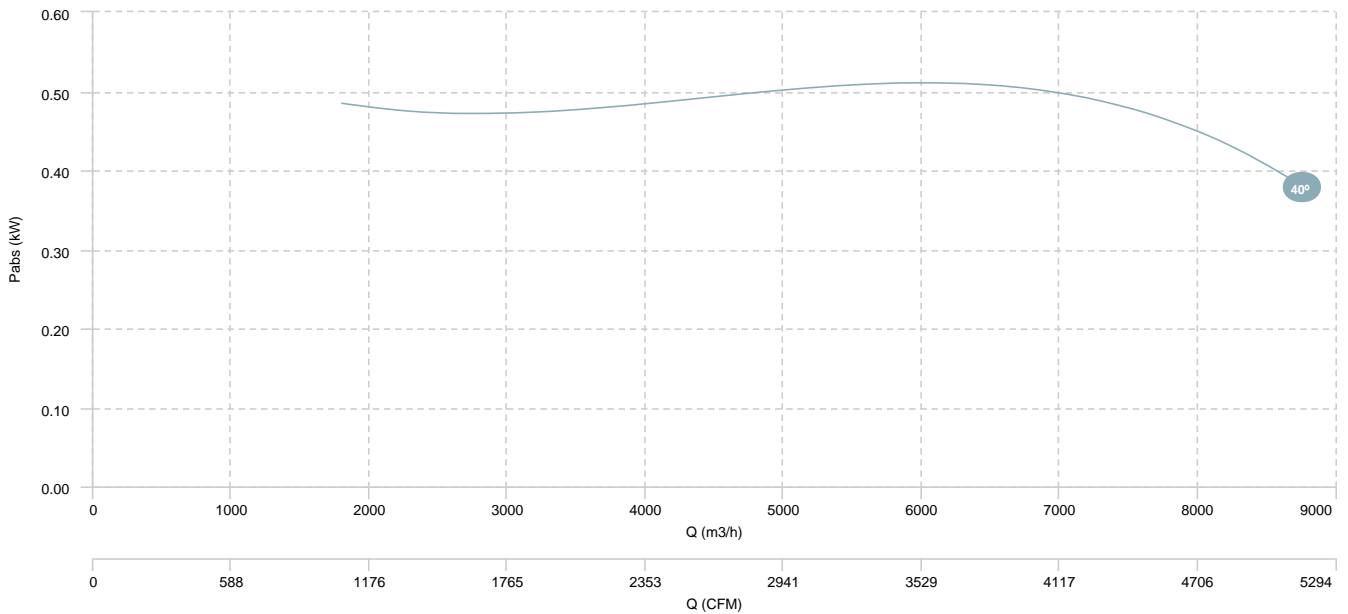

BOX HBF 50 T4/T8 0,8/0,2kW (A5:6)  
F400

AIR FLOW - PRESSURE (8 poles)

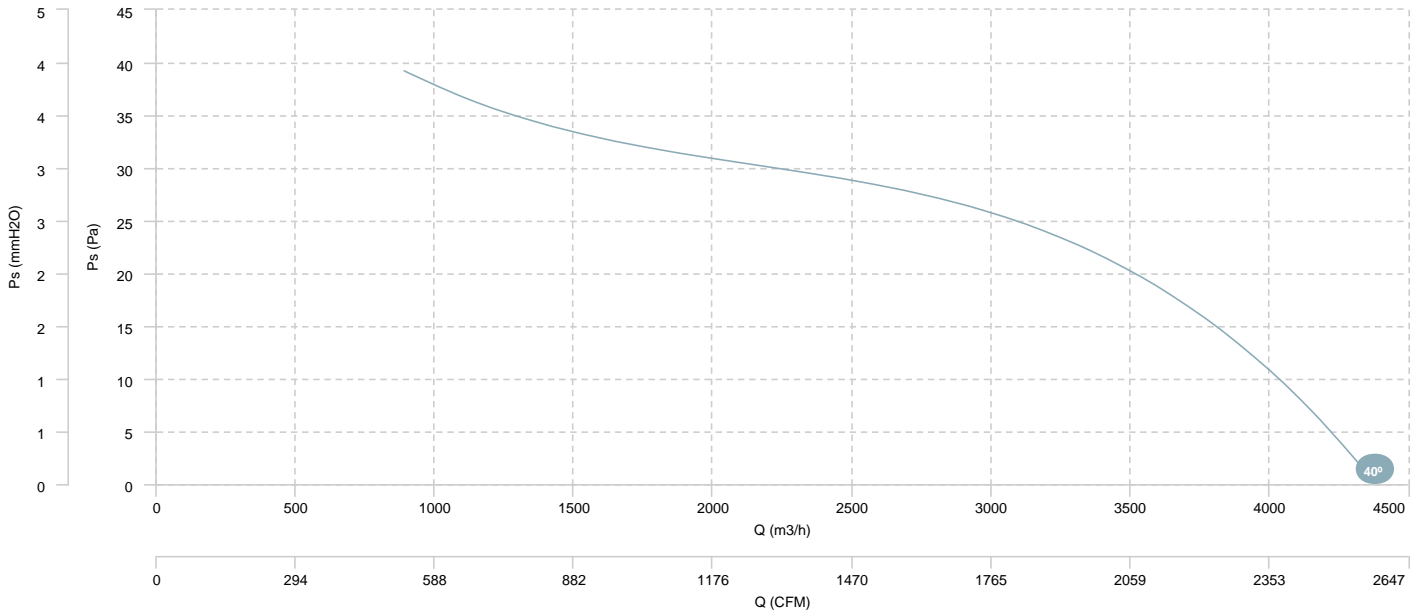

BOX HBF 56 T4 0,75kW (A5:6) F400

BOX HBF 56 T4 1,1kW (A5:6) F400

BOX HBF 56 T4 1,5kW (A5:6) F400

AIR FLOW - PRESSURE

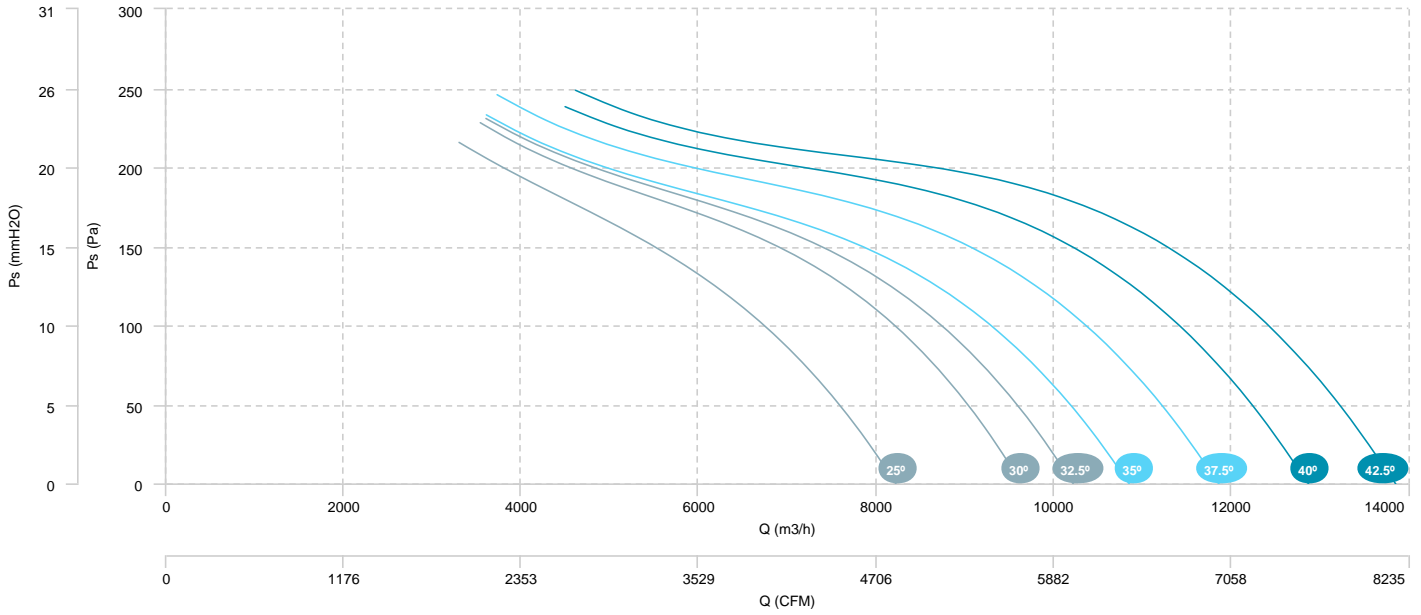

AIR FLOW - ABSORBED POWER

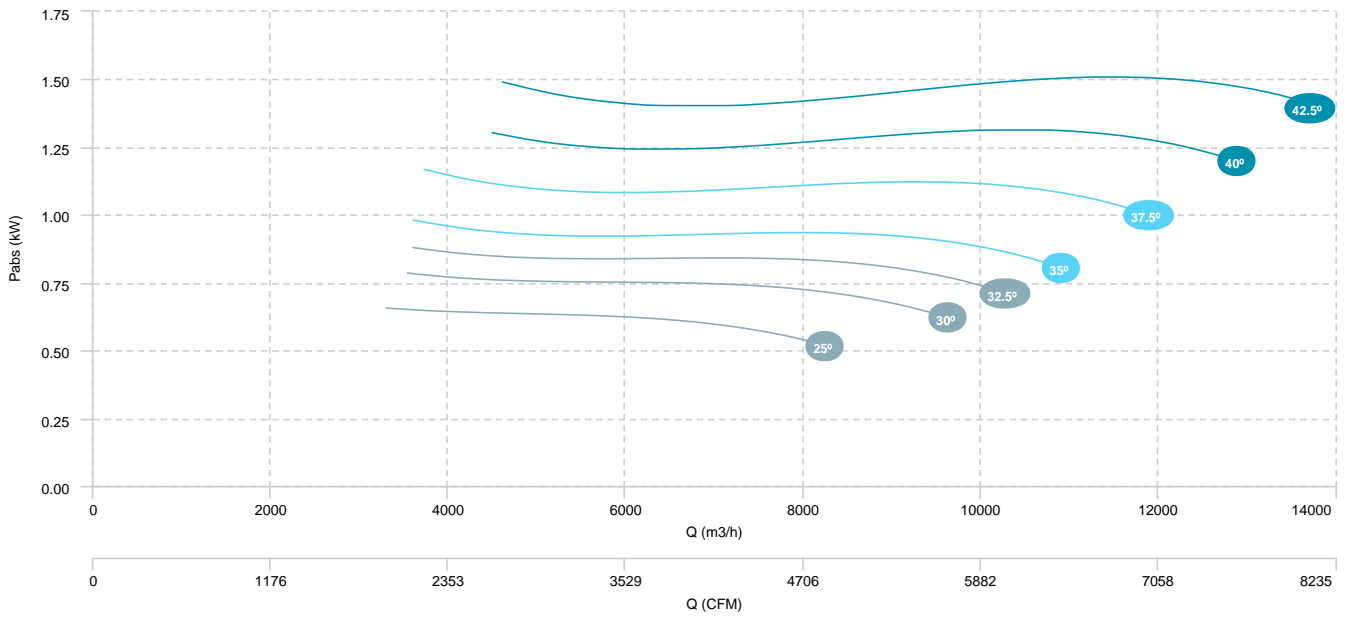

BOX HBF 56 T6 0,75kW (A5:6) F400

AIR FLOW - PRESSURE

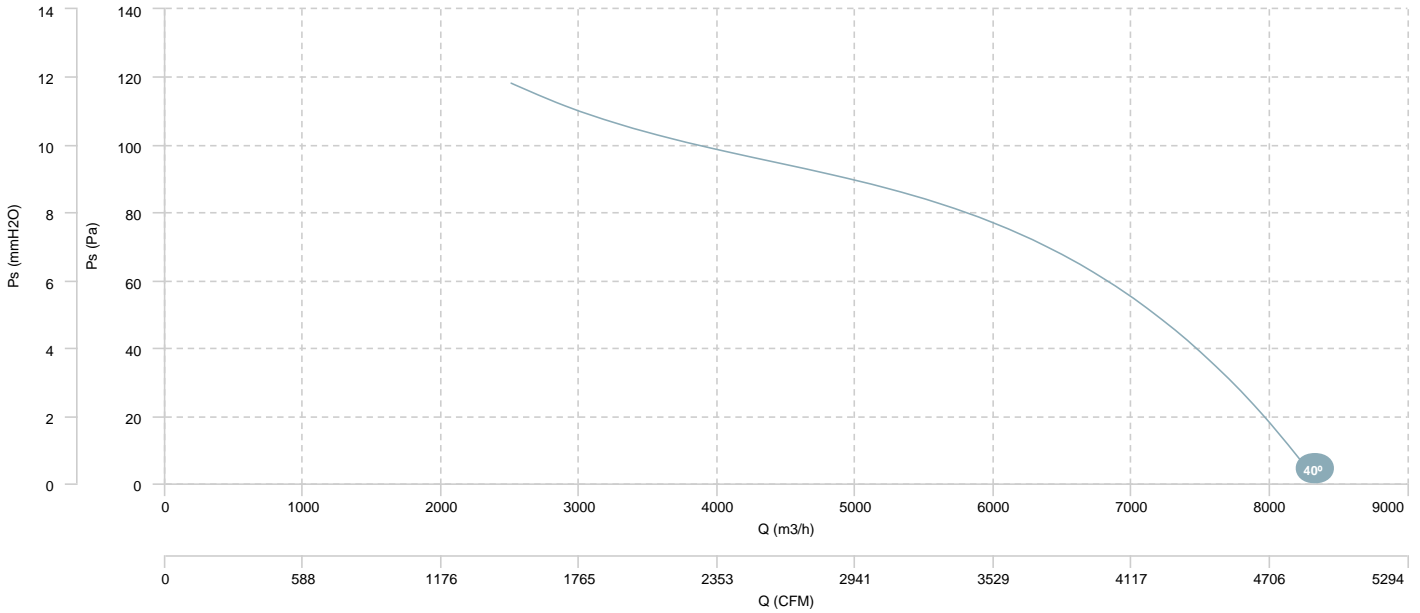

AIR FLOW - ABSORBED POWER

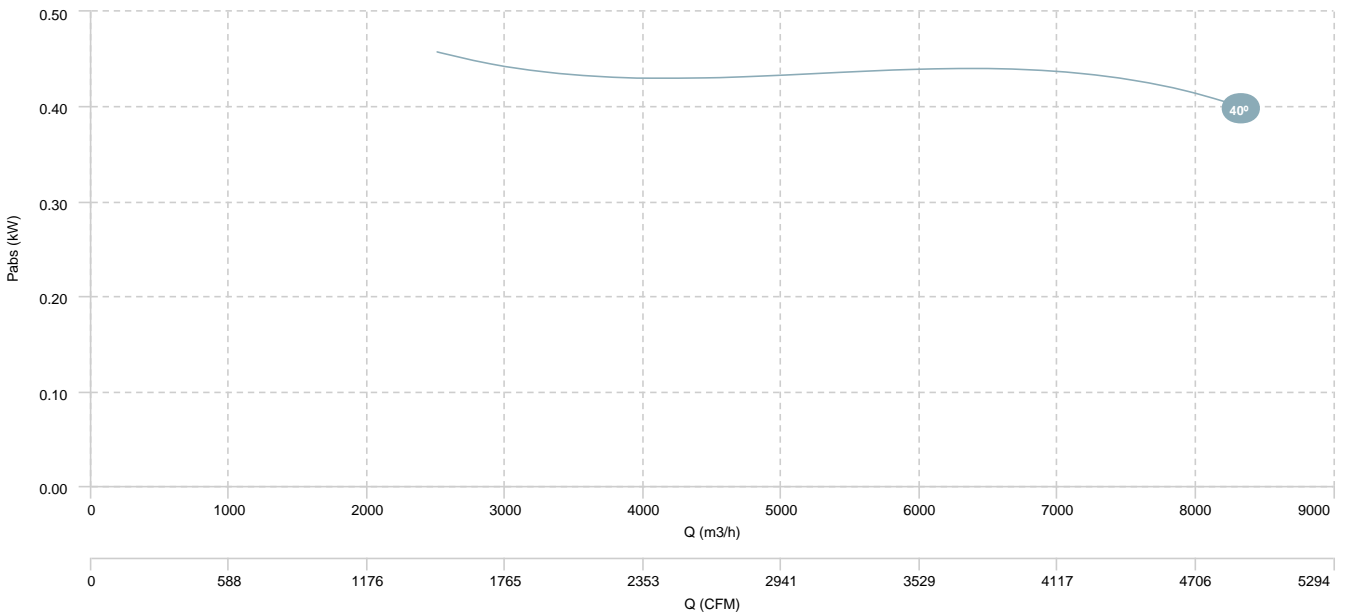

BOX HBF 56 T4/T8 0,8/0,2kW (A5:6)  
F400

BOX HBF 56 T4/T8 1,2/0,3kW (A5:6)  
F400

BOX HBF 56 T4/T8 1,6/0,4kW (A5:6)  
F400

AIR FLOW - PRESSURE (4 poles)

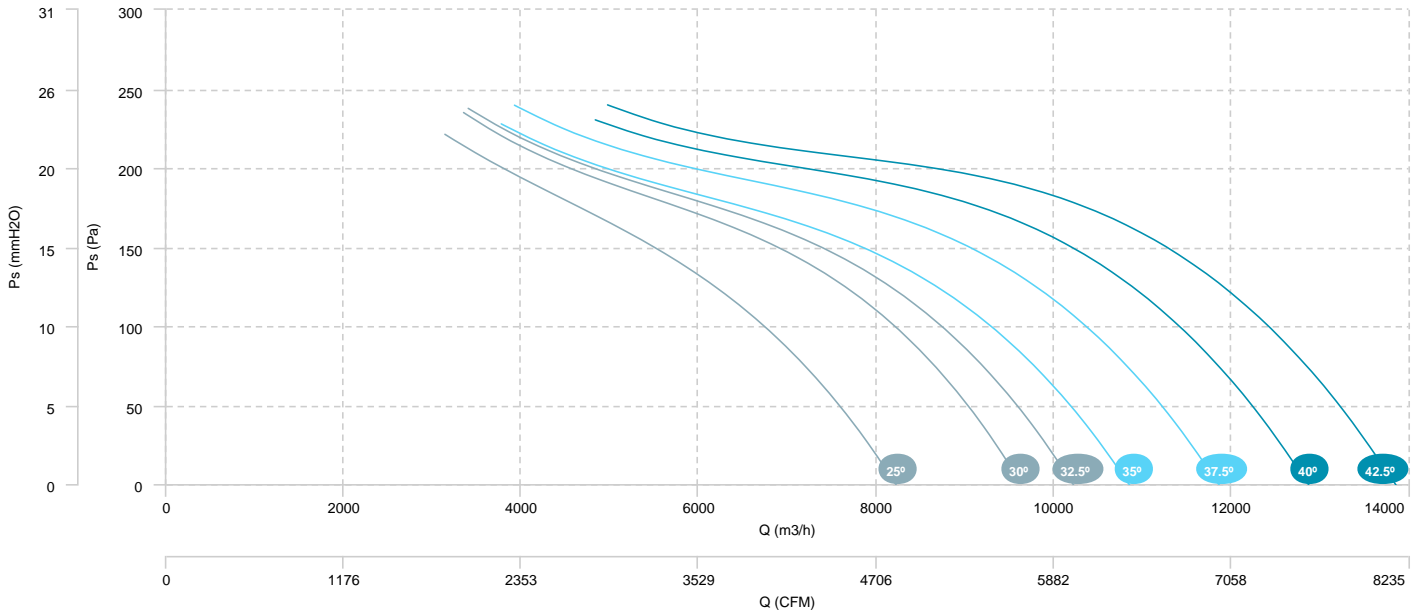

AIR FLOW - ABSORBED POWER (4 poles)

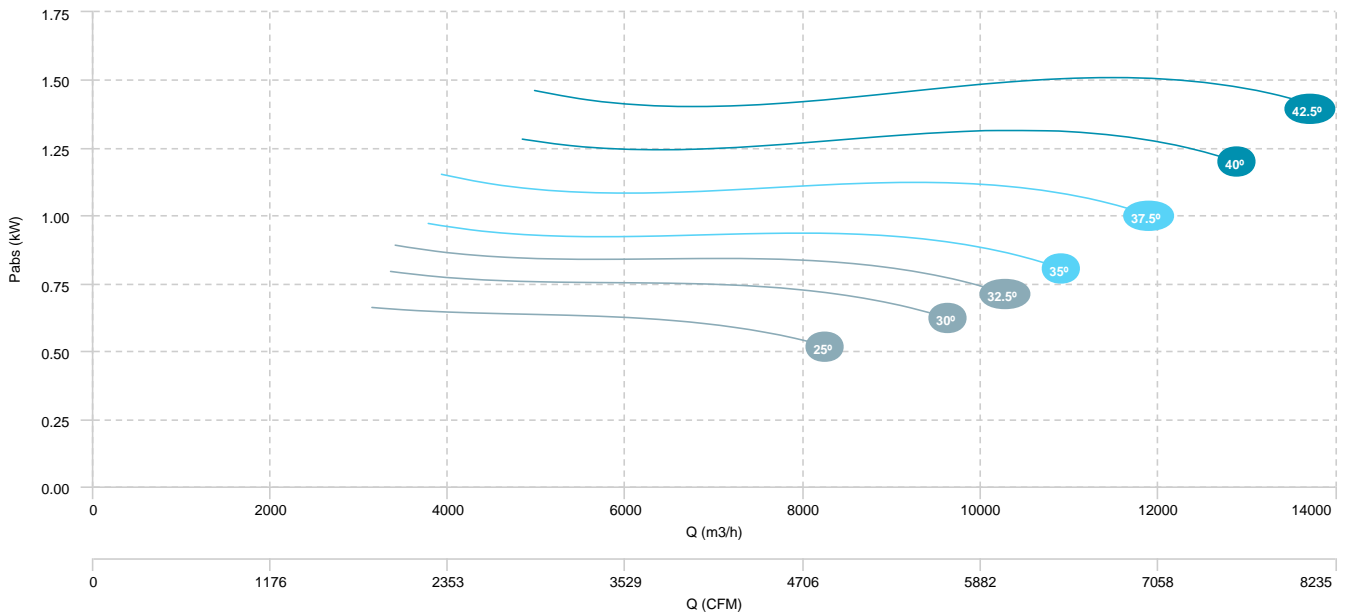

BOX HBF 56 T4/T8 0,8/0,2kW (A5:6)  
F400

BOX HBF 56 T4/T8 1,2/0,3kW (A5:6)  
F400

BOX HBF 56 T4/T8 1,6/0,4kW (A5:6)  
F400

AIR FLOW - PRESSURE (8 poles)

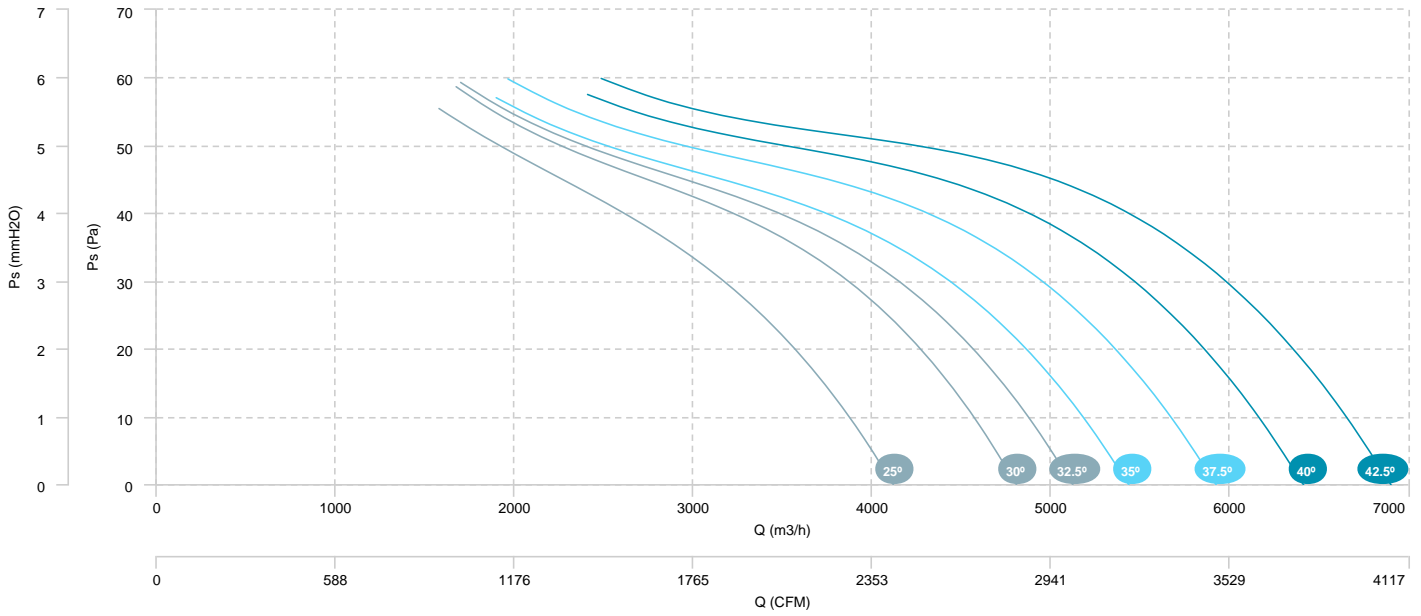

BOX HBF 63 T4 0,75kW (A5:6) F400

BOX HBF 63 T4 1,1kW (A5:6) F400

BOX HBF 63 T4 1,5kW (A5:6) F400

BOX HBF 63 T4 2,2kW (A5:6) F400

AIR FLOW - PRESSURE

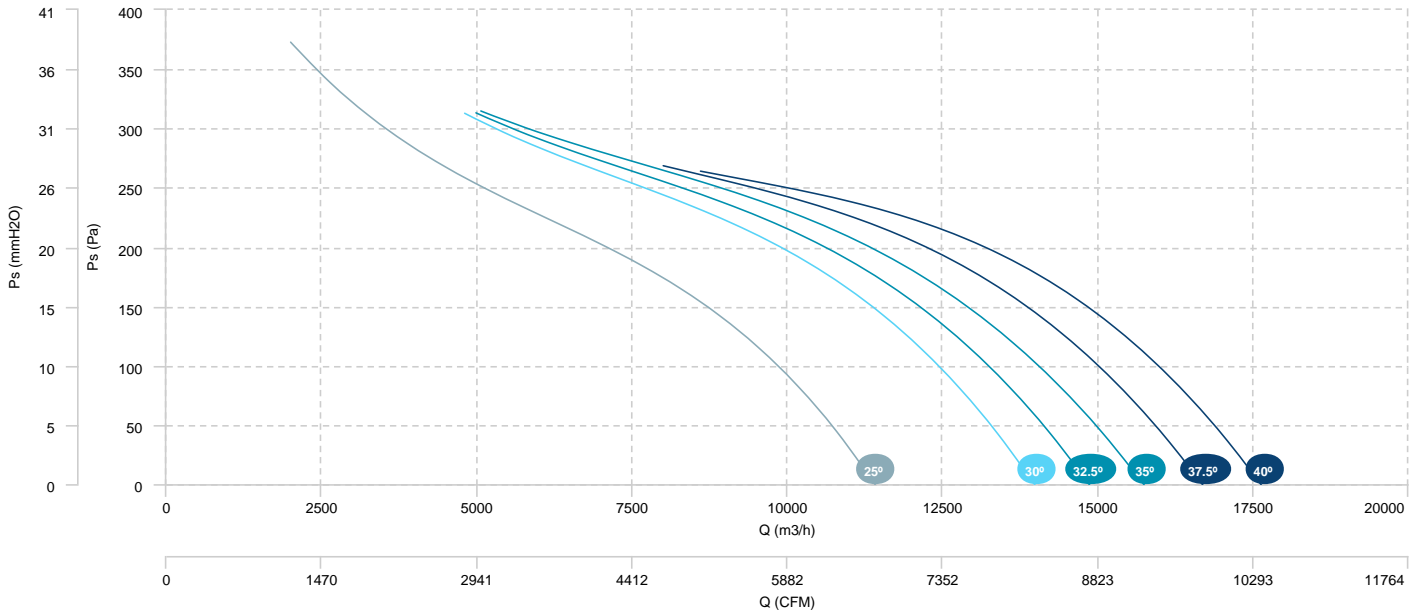

AIR FLOW - ABSORBED POWER

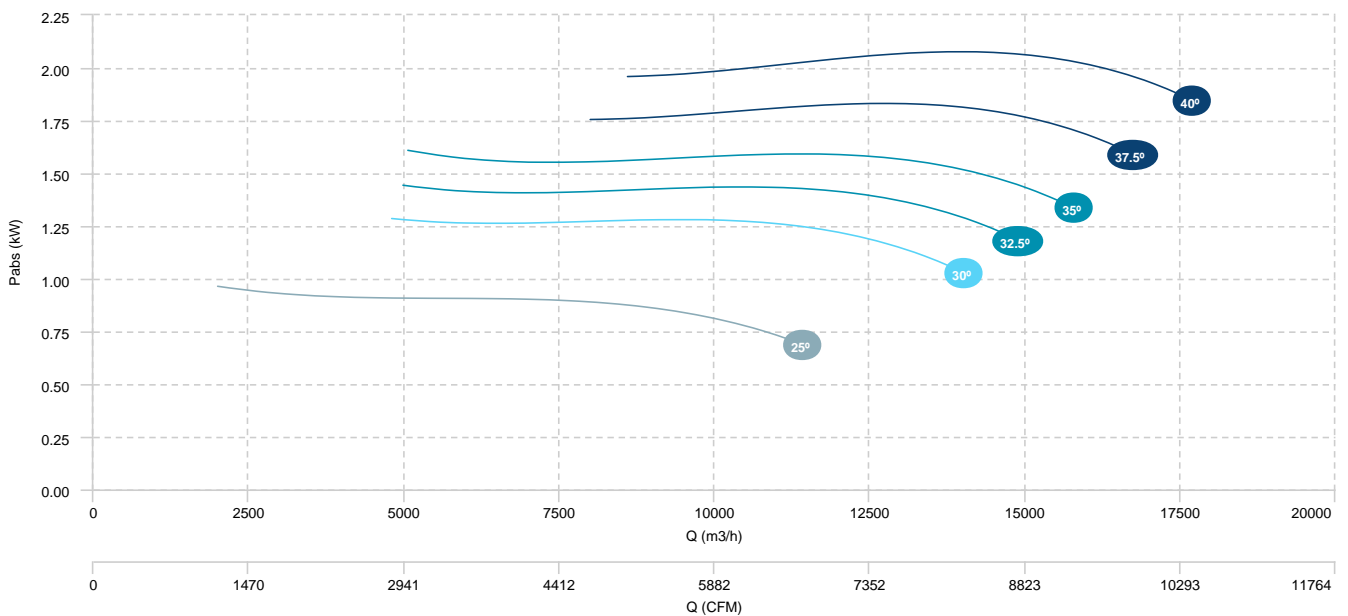



BOX HBF 63 T6 0,75kW (A5:6) F400

AIR FLOW - PRESSURE

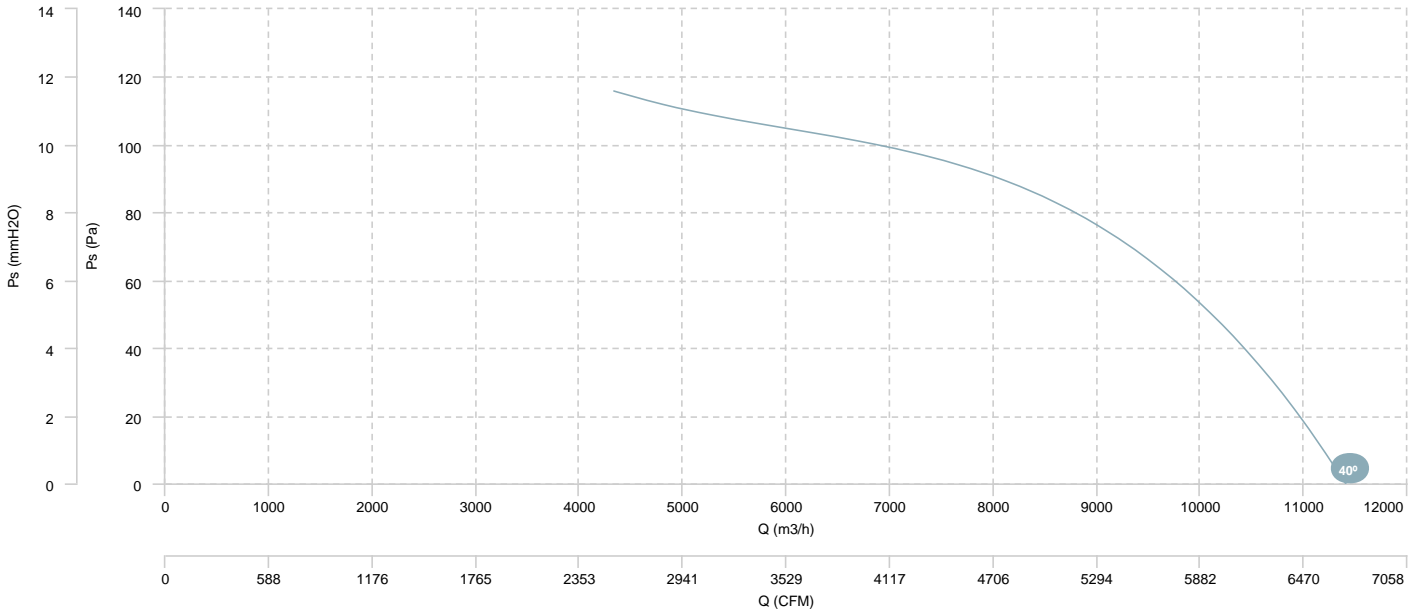

AIR FLOW - ABSORBED POWER

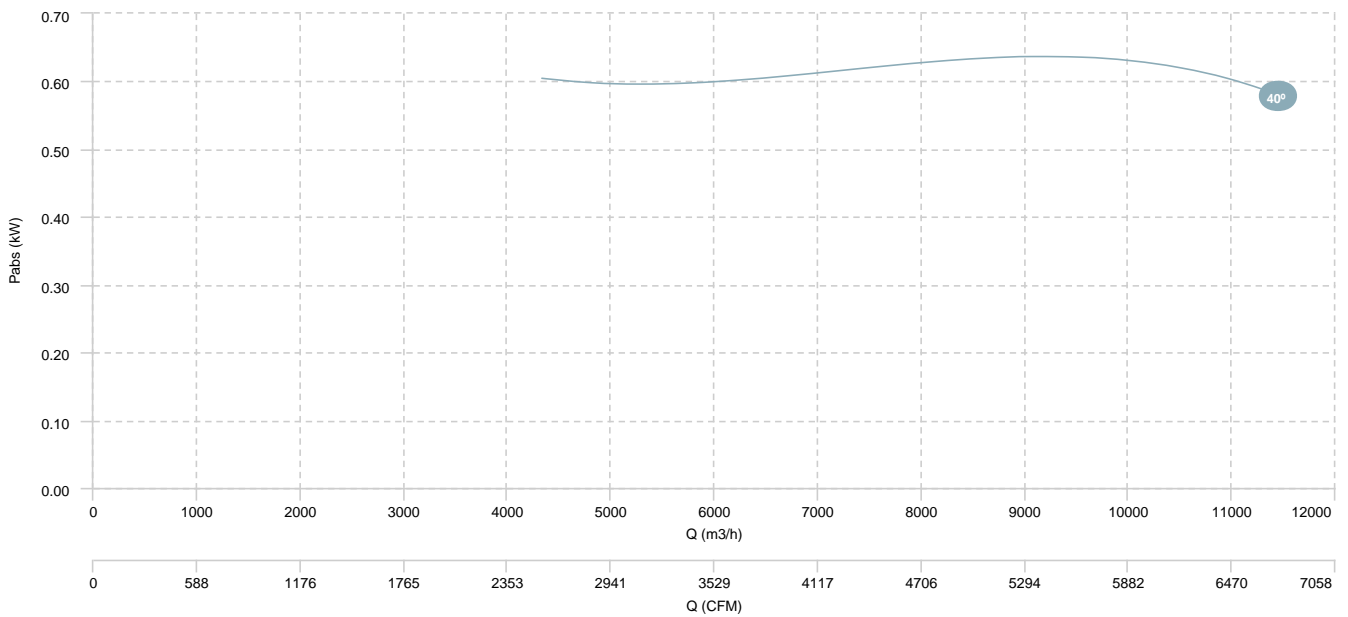

BOX HBF 63 T4/T8 0,8/0,2kW (A5:6)  
F400

BOX HBF 63 T4/T8 1,2/0,3kW (A5:6)  
F400

BOX HBF 63 T4/T8 1,6/0,4kW (A5:6)  
F400

BOX HBF 63 T4/T8 2,2/0,37kW (A5:6)  
F400

AIR FLOW - PRESSURE (4 poles)

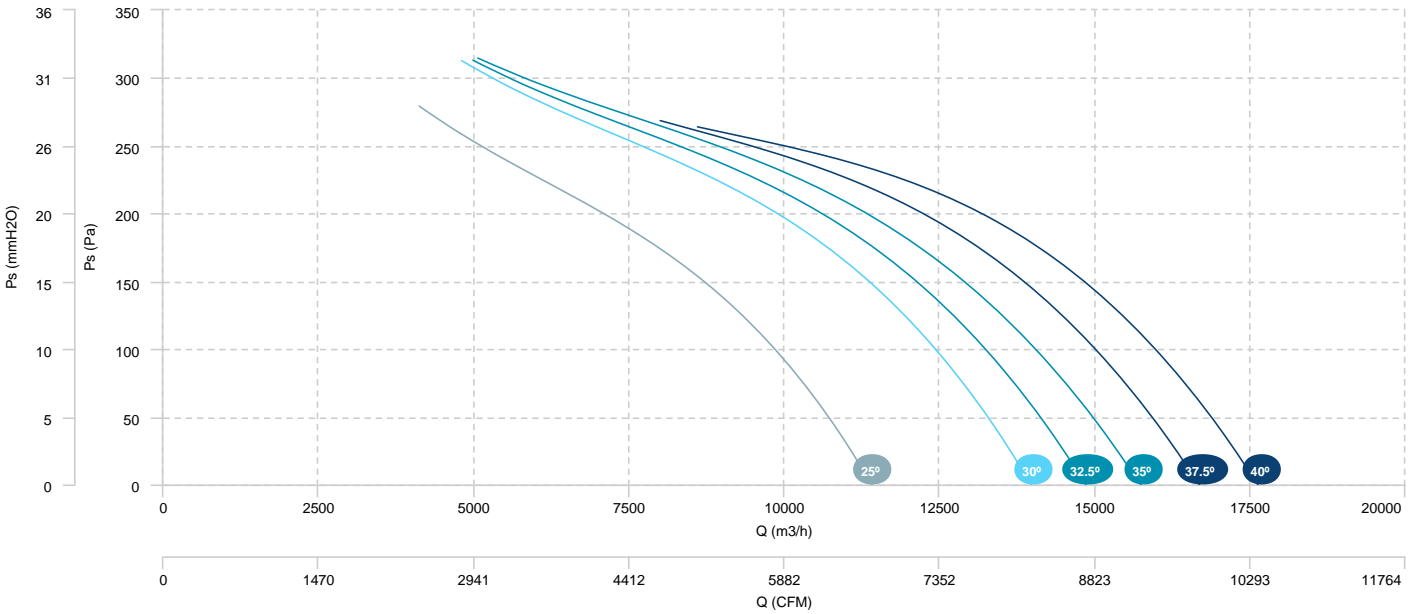

AIR FLOW - ABSORBED POWER (4 poles)

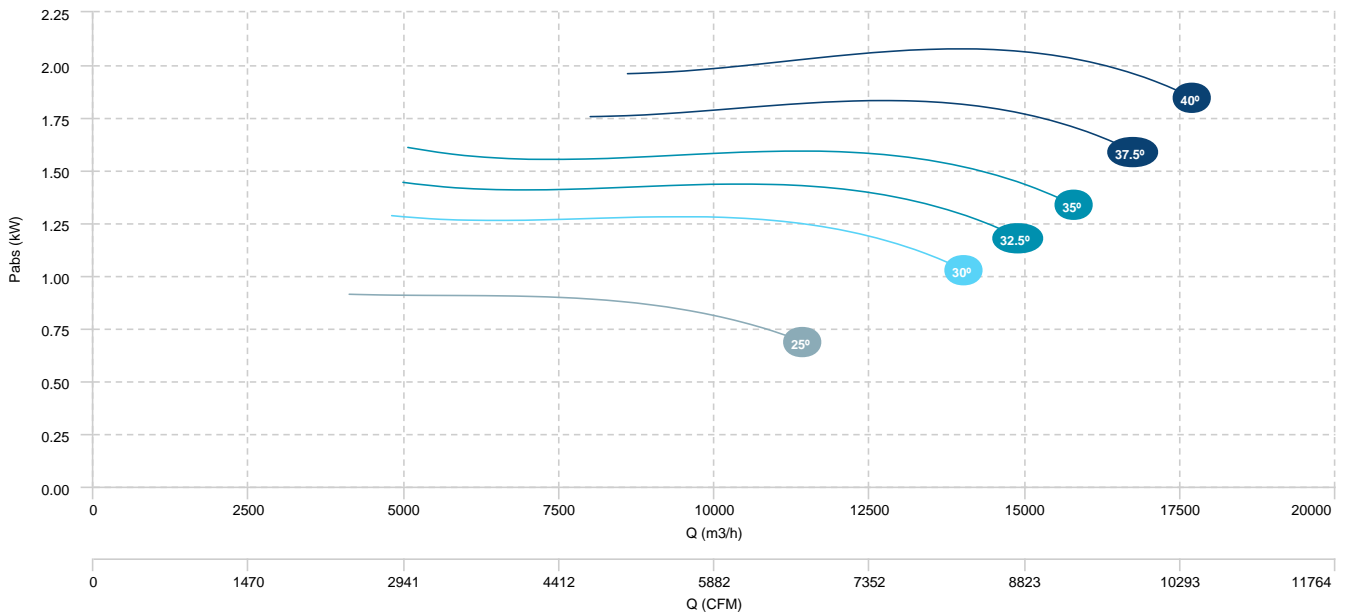

BOX HBF 63 T4/T8 0,8/0,2kW (A5:6)  
F400

BOX HBF 63 T4/T8 2,2/0,37kW (A5:6)  
F400

BOX HBF 63 T4/T8 1,2/0,3kW (A5:6)  
F400

BOX HBF 63 T4/T8 1,6/0,4kW (A5:6)  
F400

AIR FLOW - PRESSURE (8 poles)

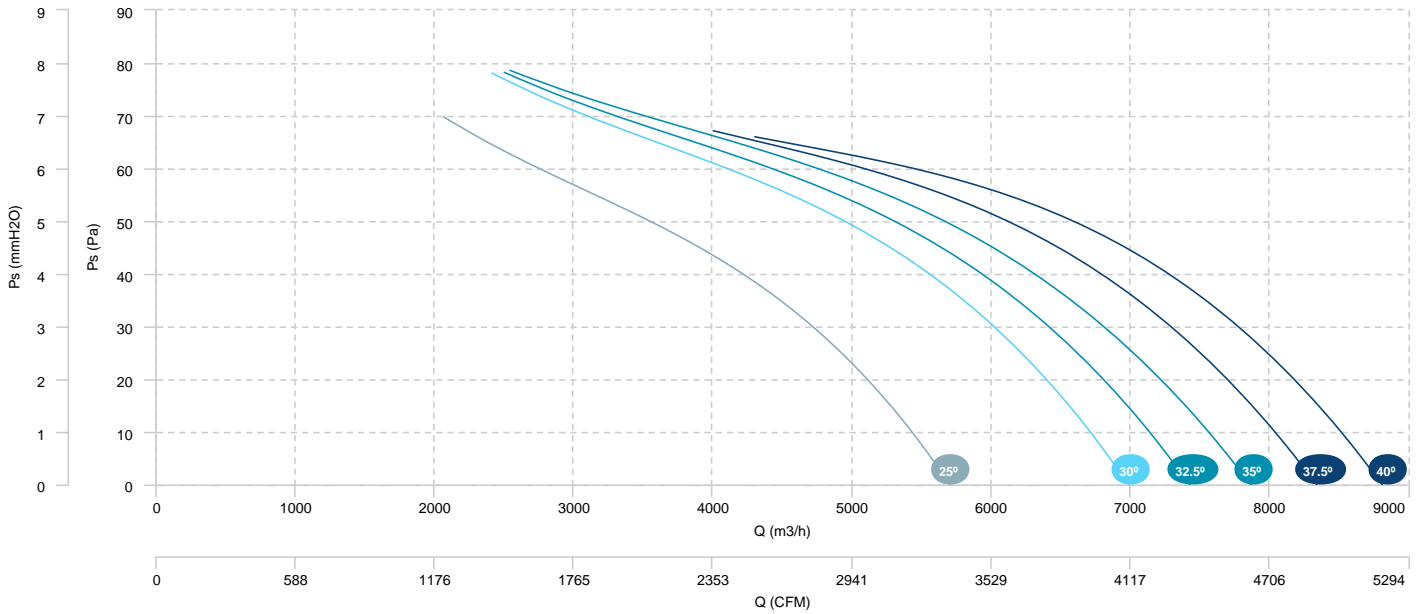

BOX HBF 71 T4 0,75kW (A5:6) F400	BOX HBF 71 T4 1,1kW (A5:6) F400	BOX HBF 71 T4 1,5kW (A5:6) F400
BOX HBF 71 T4 2,2kW (A5:6) F400	BOX HBF 71 T4 3kW (A5:6) F400	

AIR FLOW - PRESSURE

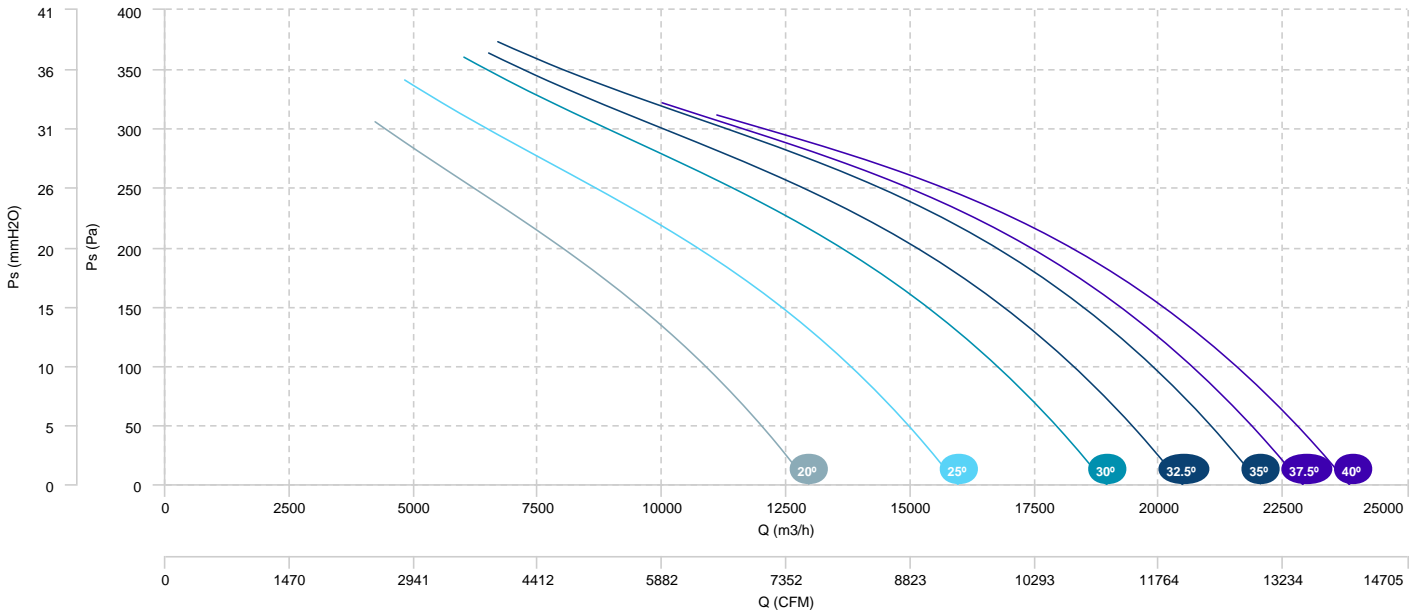

AIR FLOW - ABSORBED POWER

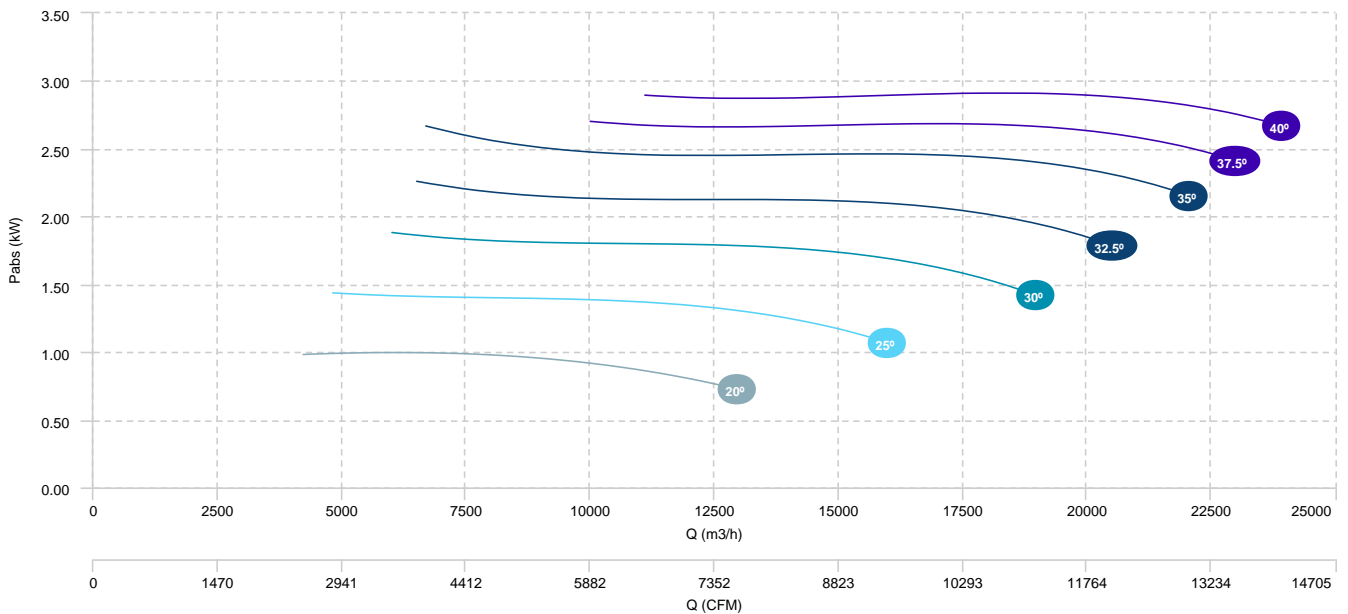

BOX HBF 71 T6 0,75kW (A5:6) F400

AIR FLOW - PRESSURE

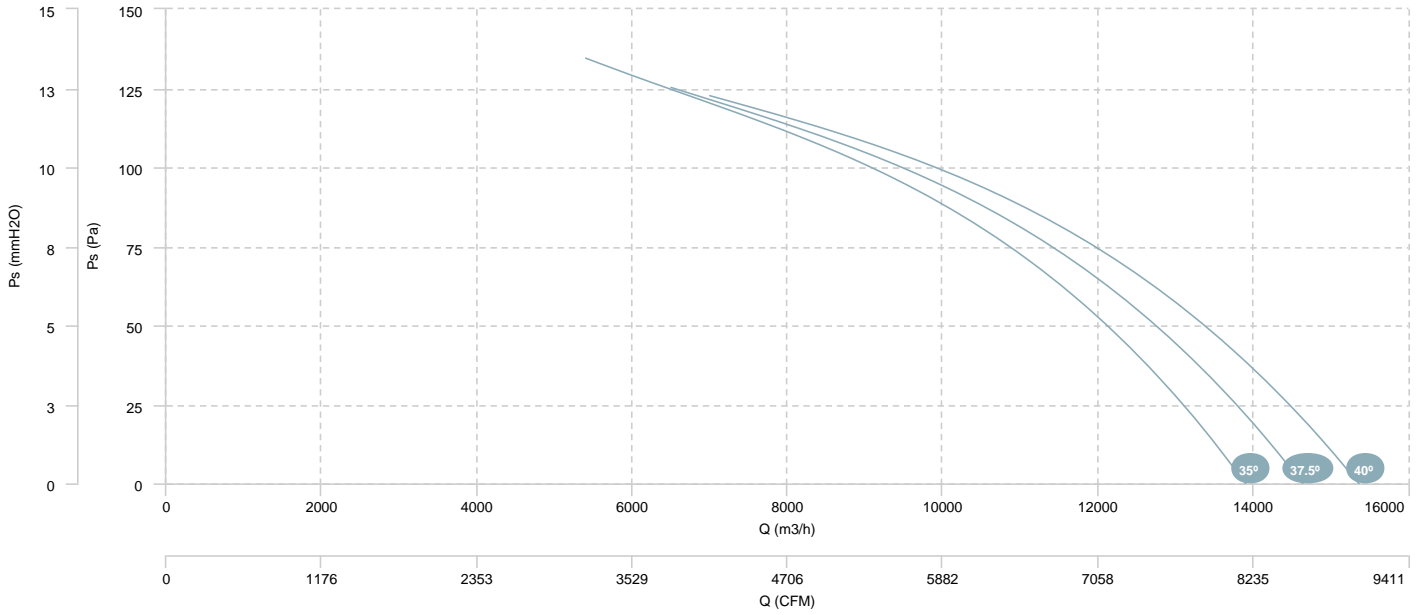

AIR FLOW - ABSORBED POWER

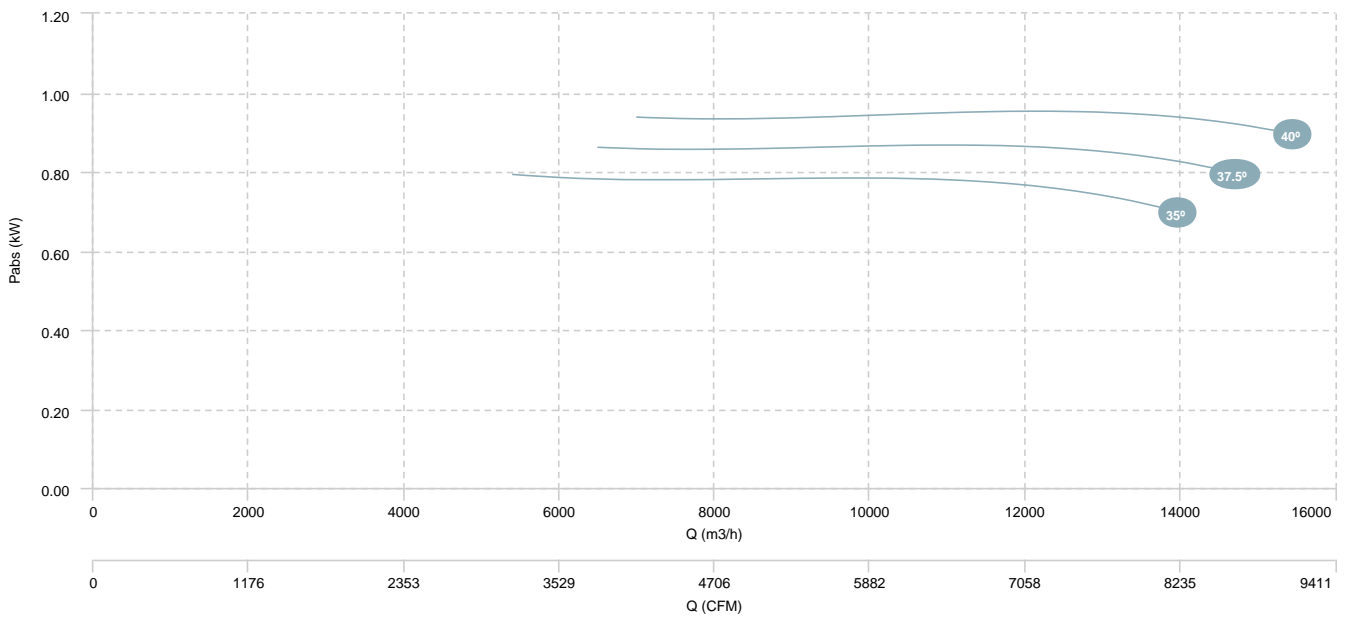

BOX HBF 71 T4/T8 0,8/0,2kW (A5:6) F400	BOX HBF 71 T4/T8 1,2/0,3kW (A5:6) F400	BOX HBF 71 T4/T8 1,6/0,4kW (A5:6) F400
BOX HBF 71 T4/T8 2,2/0,37kW (A5:6) F400	BOX HBF 71 T4/T8 3/0,55kW (A5:6) F400	

AIR FLOW - PRESSURE (4 poles)

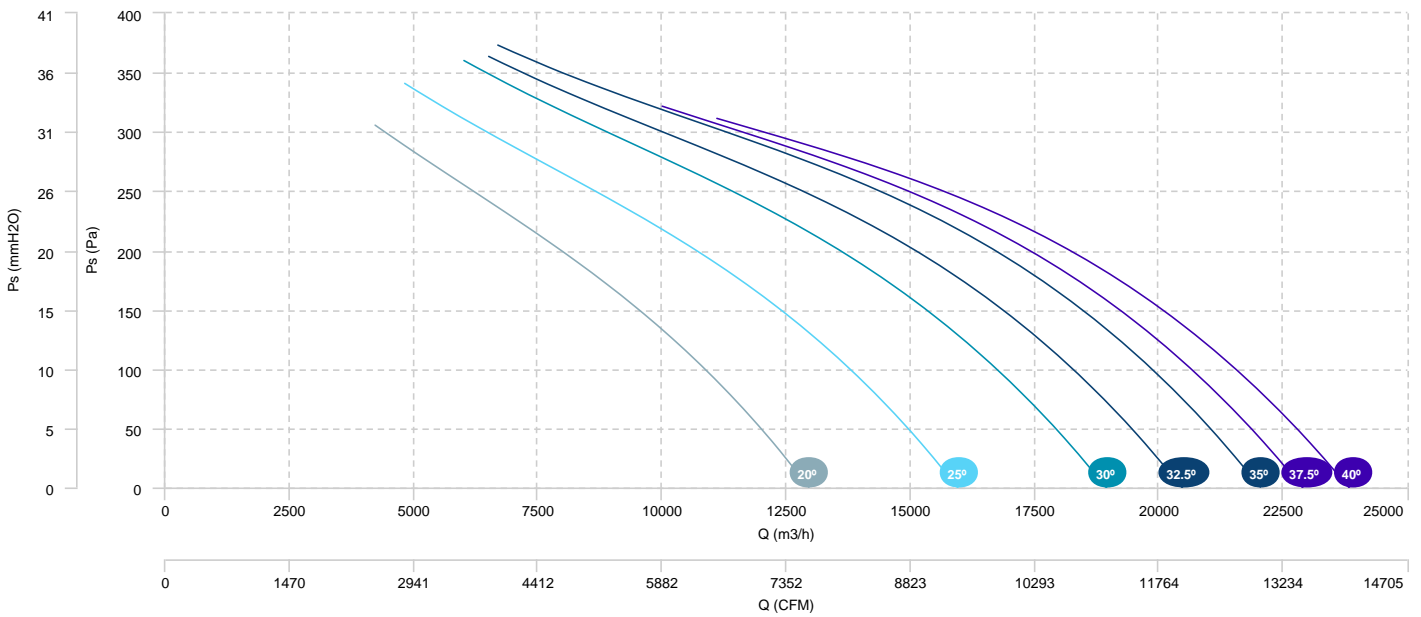

AIR FLOW - ABSORBED POWER (4 poles)

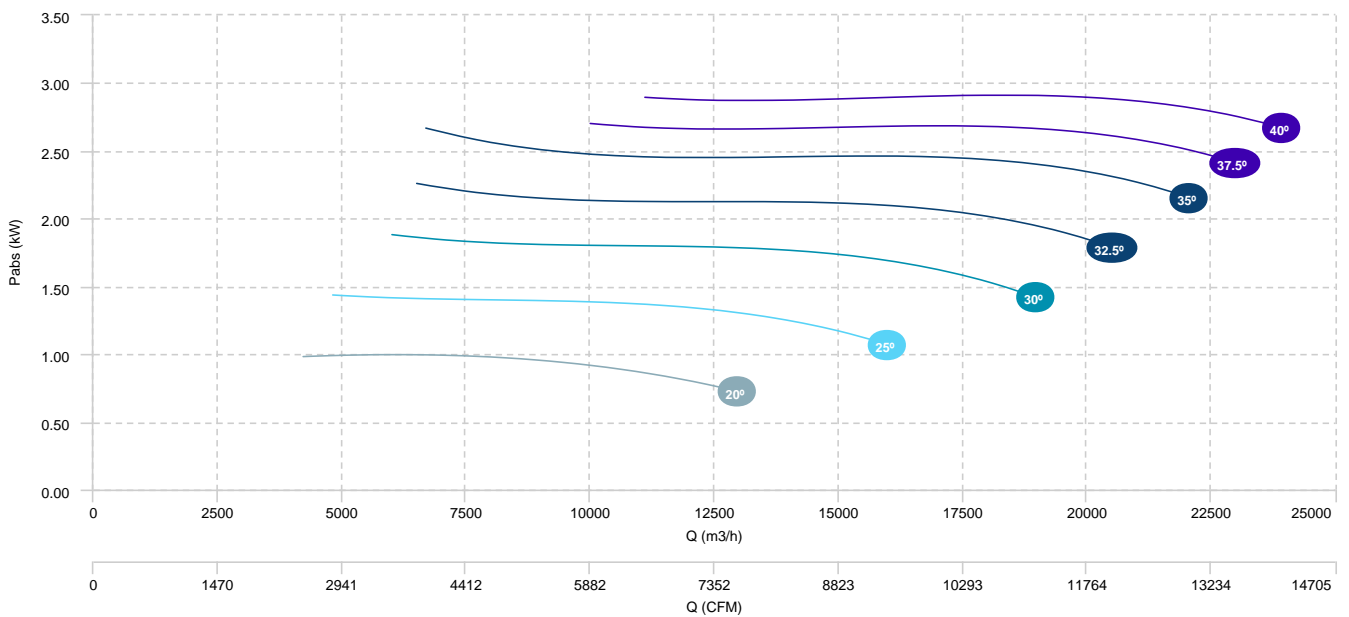

BOX HBF 71 T4/T8 0,8/0,2kW (A5:6) F400	BOX HBF 71 T4/T8 1,2/0,3kW (A5:6) F400	BOX HBF 71 T4/T8 1,6/0,4kW (A5:6) F400
BOX HBF 71 T4/T8 2,2/0,37kW (A5:6) F400	BOX HBF 71 T4/T8 3/0,55kW (A5:6) F400	

AIR FLOW - PRESSURE (8 poles)

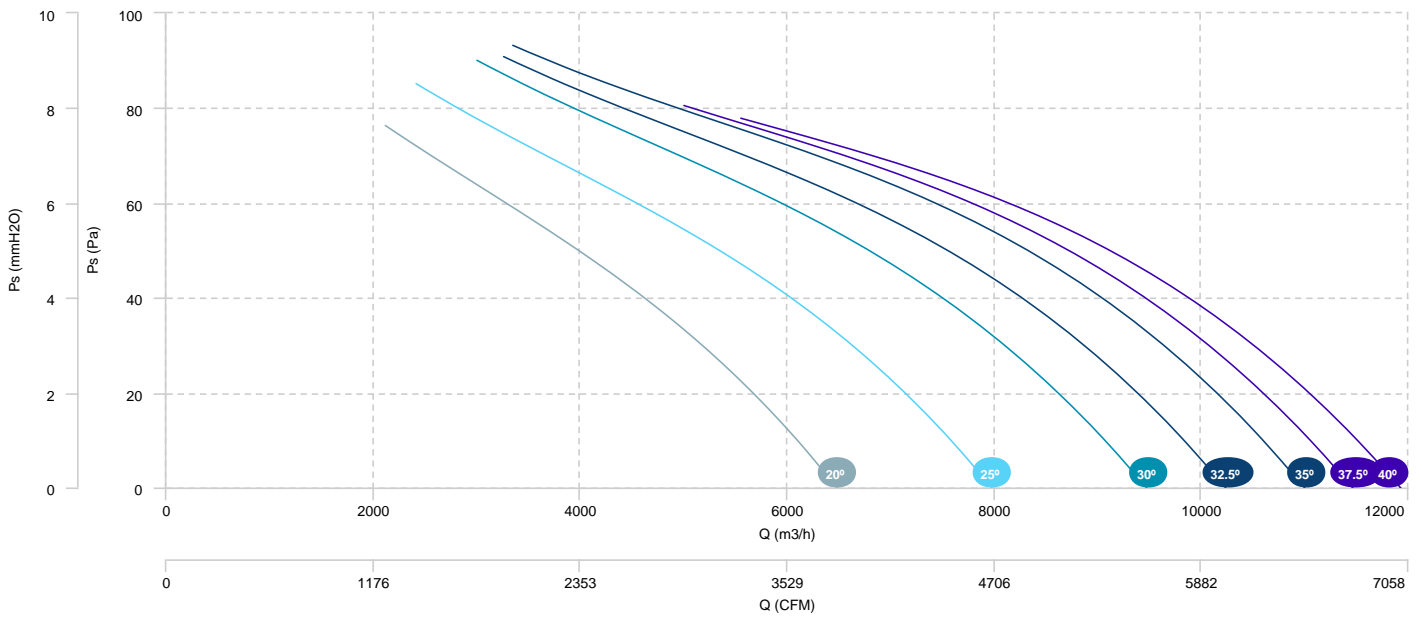

BOX HBF 80 T4 3kW (A5:6) F400

BOX HBF 80 T4 4kW (A5:6) F400

AIR FLOW - PRESSURE

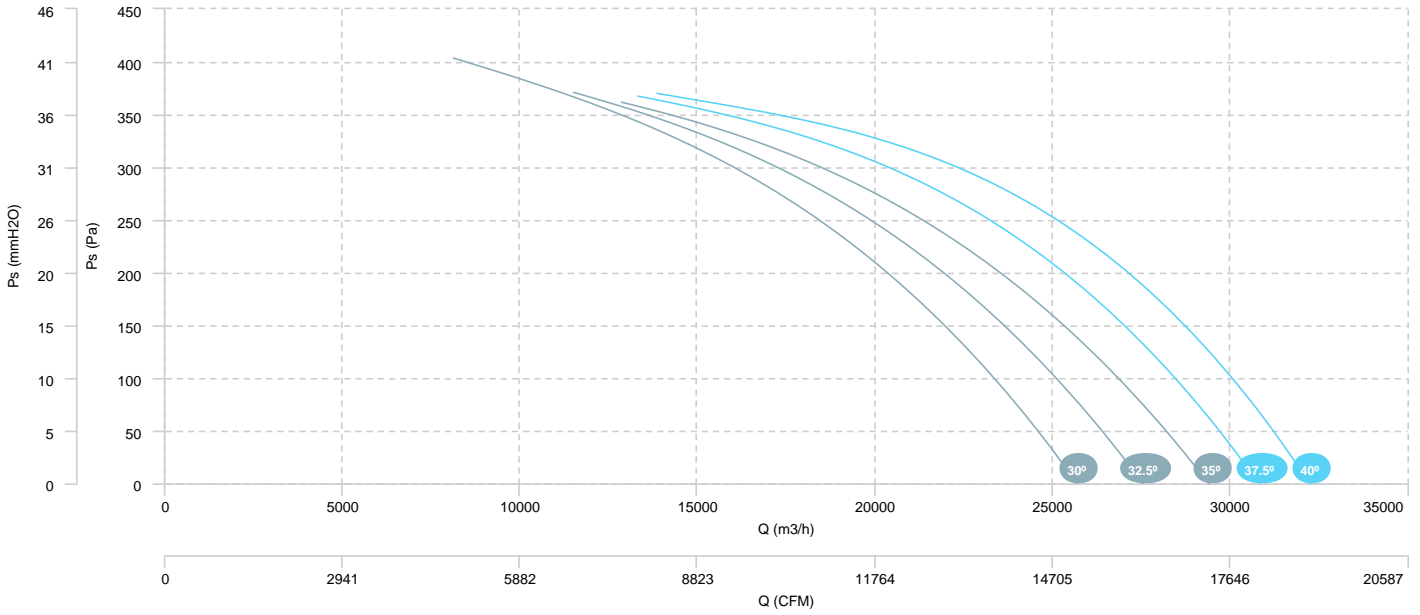

AIR FLOW - ABSORBED POWER

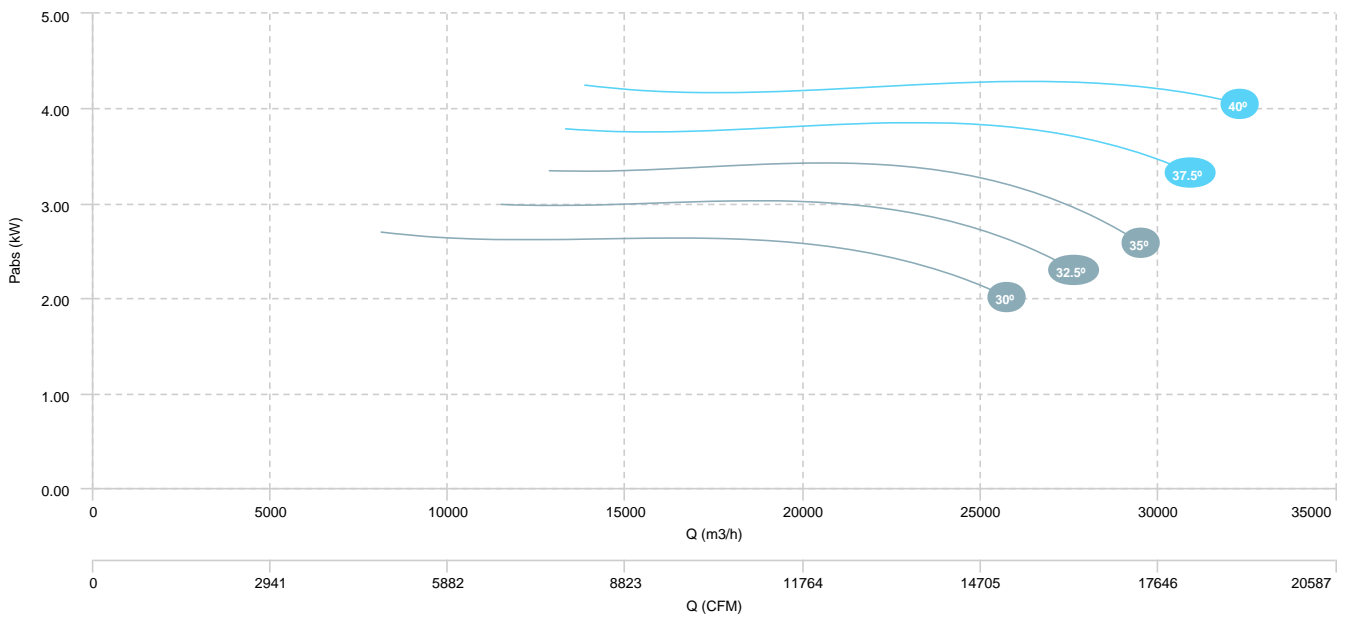



- BOX HBF 80 T6 0,75kW (A5:6) F400
  - BOX HBF 80 T6 1,1kW (A5:6) F400
  - BOX HBF 80 T6 1,5kW (A5:6) F400
- BOX HBF 80 T6 2,2kW (A5:6) F400

**AIR FLOW - PRESSURE**

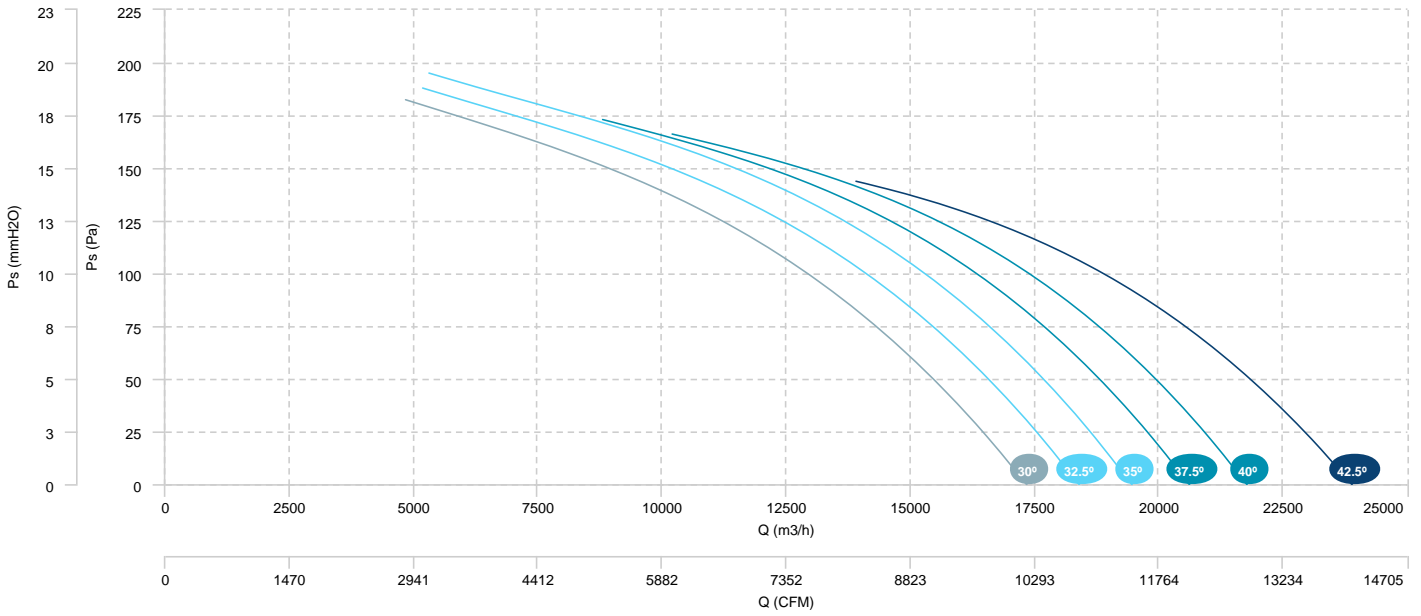

**AIR FLOW - ABSORBED POWER**

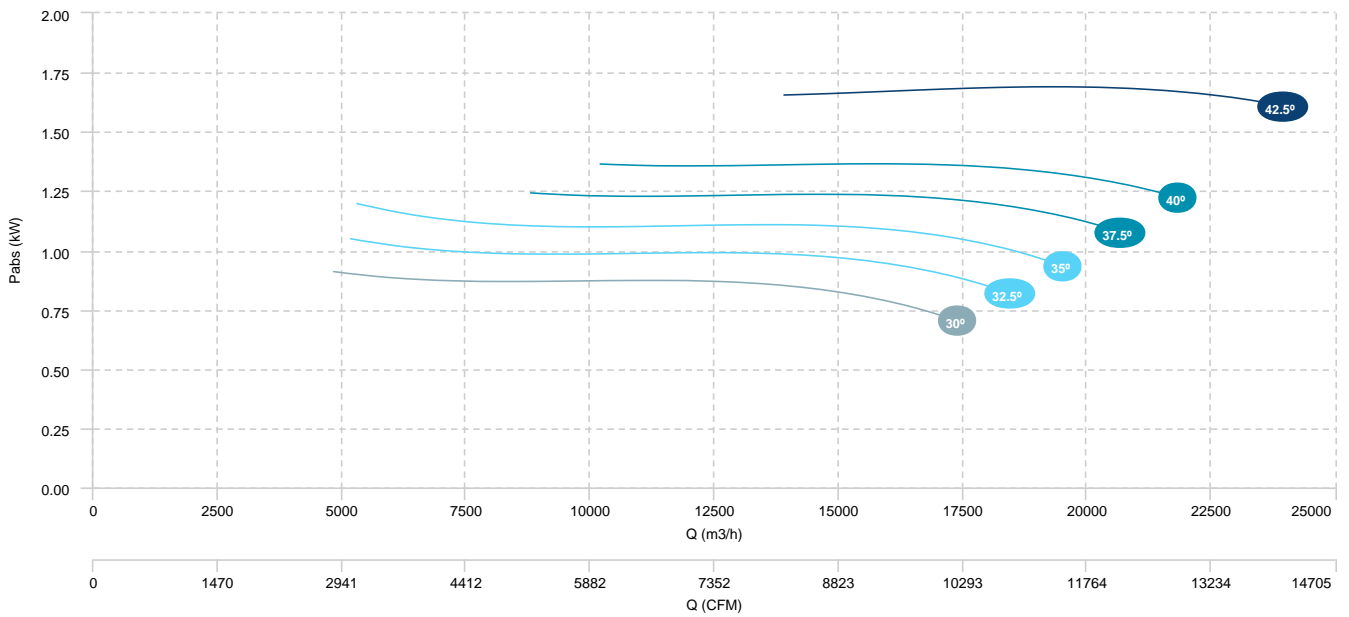

BOX HBF 80 T4/T8 3/0,55kW (A5:6) F400

BOX HBF 80 T4/T8 4/0,75kW (A5:6) F400

AIR FLOW - PRESSURE (4 poles)

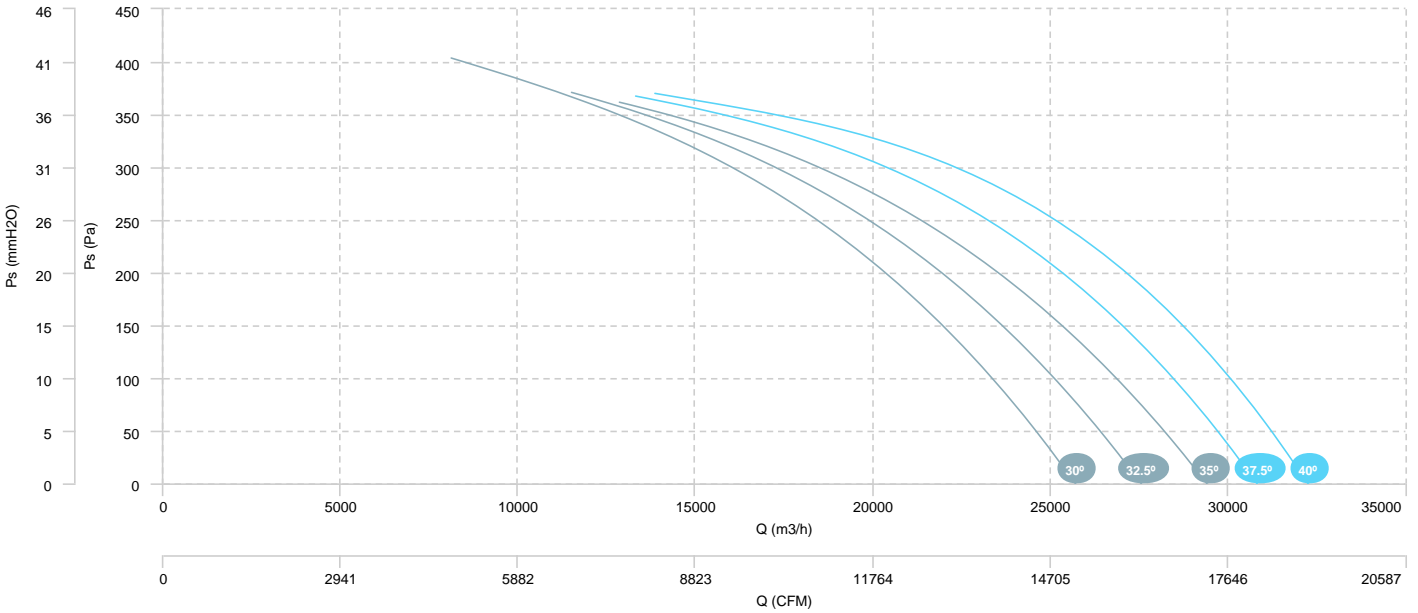

AIR FLOW - ABSORBED POWER (4 poles)

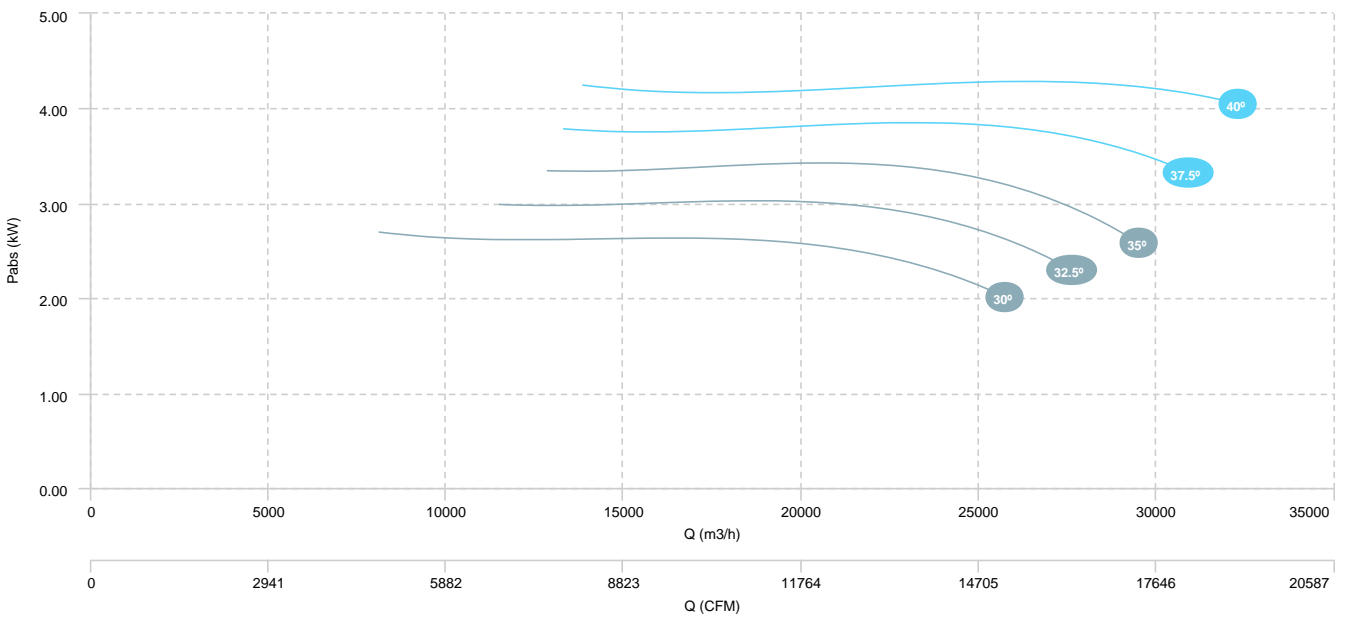

BOX HBF 80 T4/T8 3/0,55kW (A5:6) F400

BOX HBF 80 T4/T8 4/0,75kW (A5:6) F400

AIR FLOW - PRESSURE (8 poles)

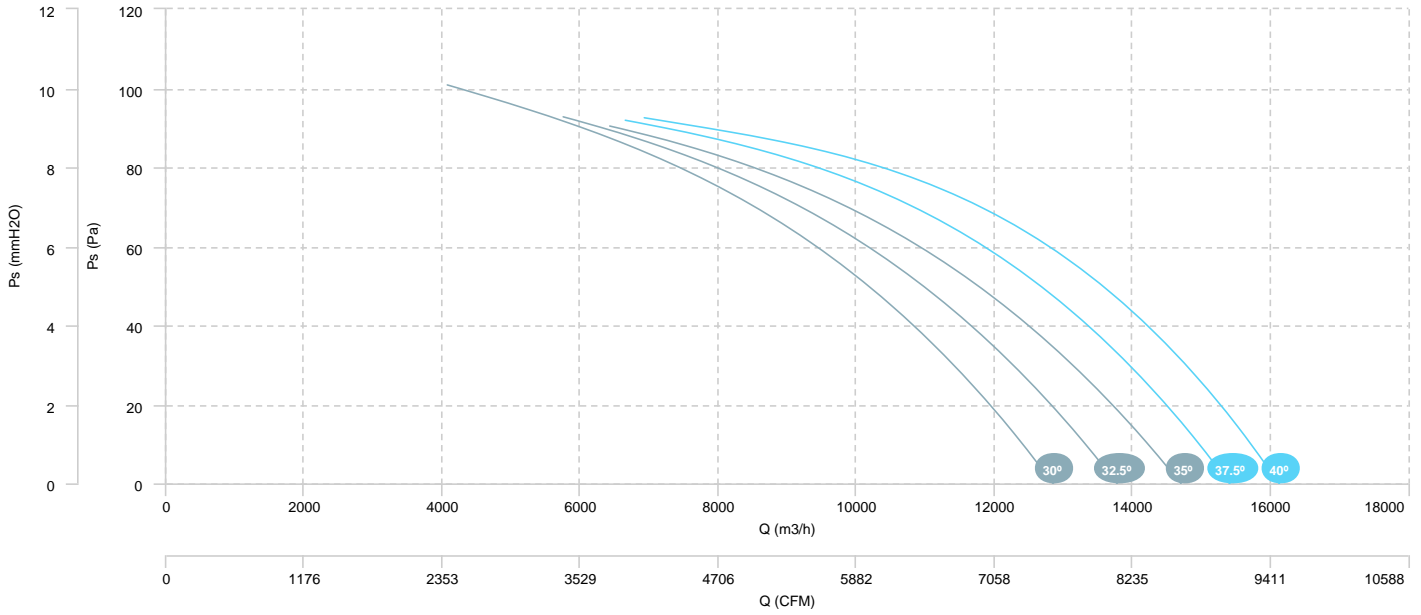

- BOX HBF 90 T4 5,5kW (A3:8) F400
- BOX HBF 90 T4 7,5kW (A3:8) F400
- BOX HBF 90 T4 11kW (A3:8) F400
- BOX HBF 90 T4 15kW (A3:8) F400

**AIR FLOW - PRESSURE**

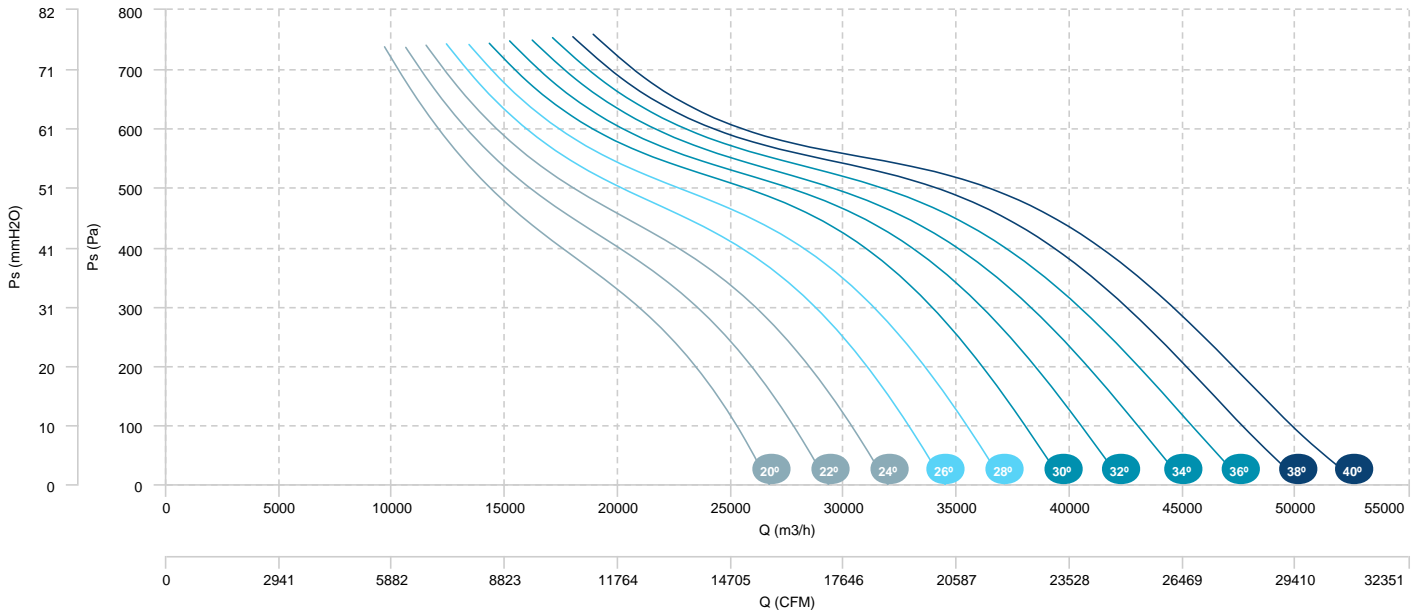

**AIR FLOW - ABSORBED POWER**

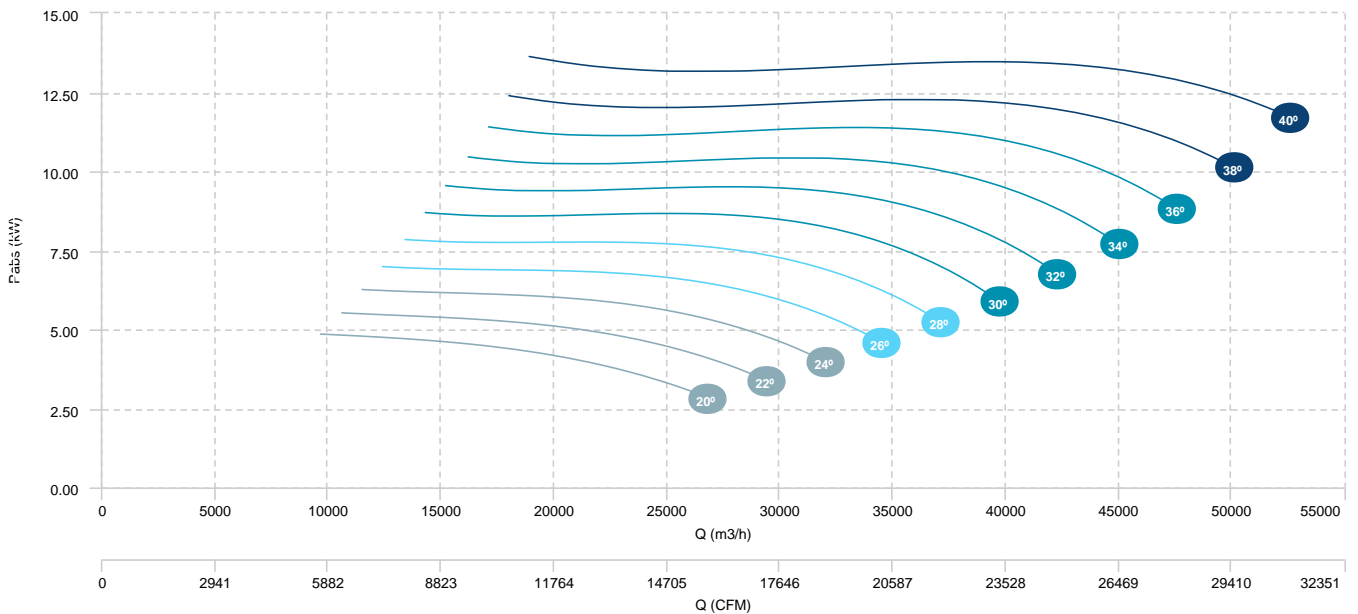

BOX HBF 90 T4 3kW (A3:4) F400	BOX HBF 90 T4 4kW (A3:4) F400	BOX HBF 90 T4 5,5kW (A3:4) F400
BOX HBF 90 T4 7,5kW (A3:4) F400	BOX HBF 90 T4 11kW (A3:4) F400	

AIR FLOW - PRESSURE

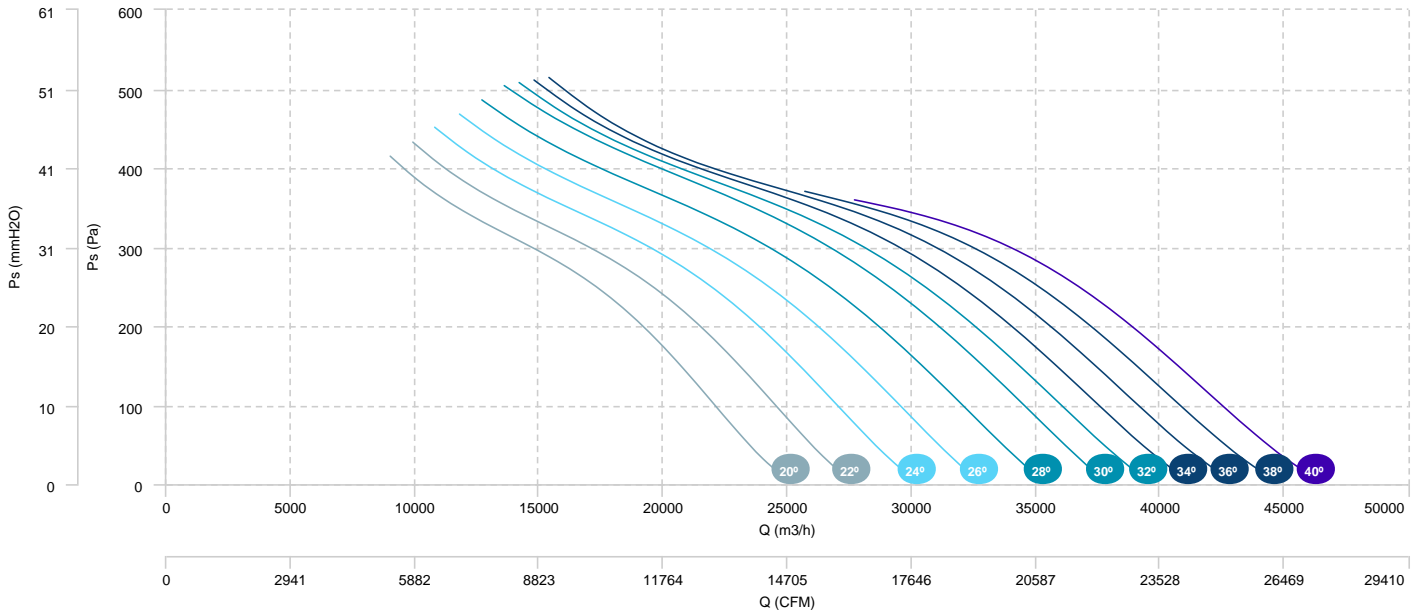

AIR FLOW - ABSORBED POWER

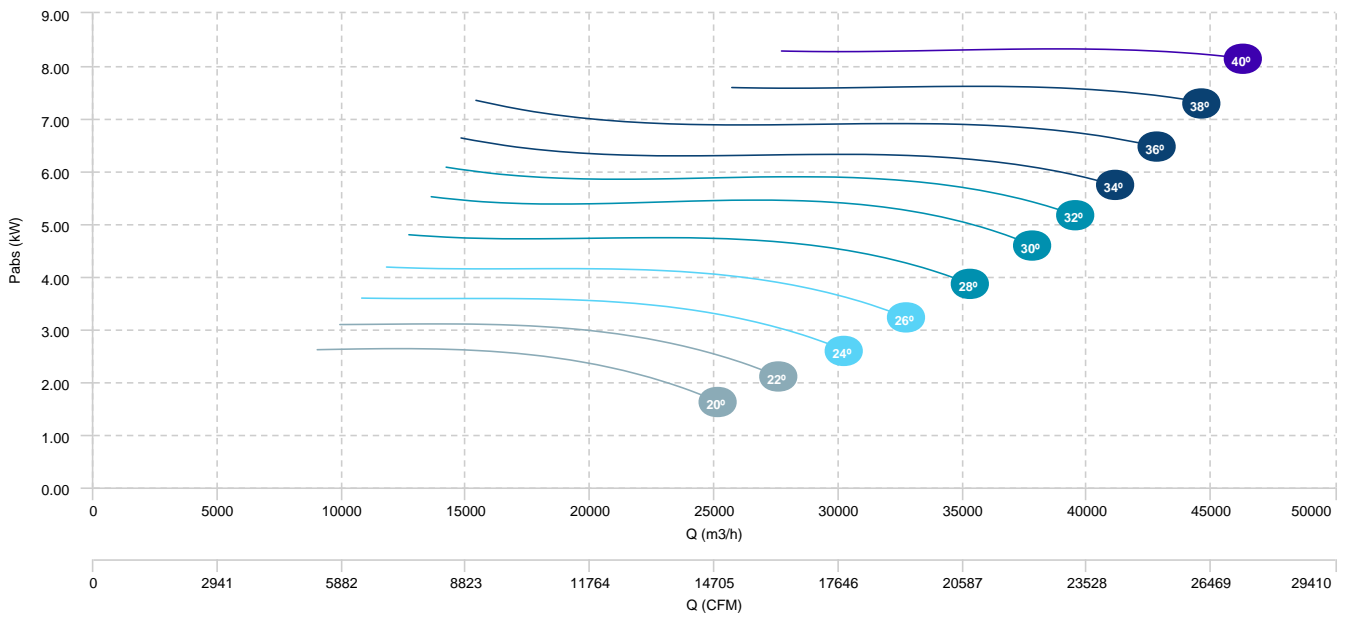

- BOX HBF 90 T6 1,5kW (A3:8) F400
- BOX HBF 90 T6 2,2kW (A3:8) F400
- BOX HBF 90 T6 3kW (A3:8) F400
- BOX HBF 90 T6 4kW (A3:8) F400

**AIR FLOW - PRESSURE**

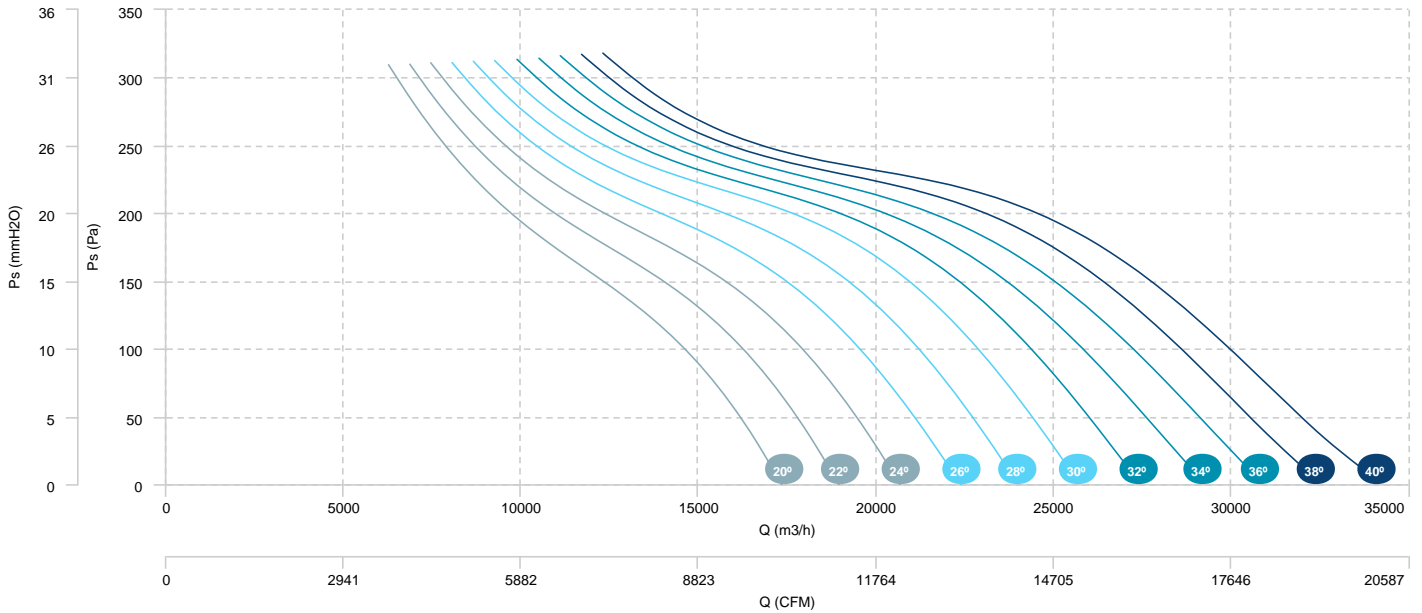

**AIR FLOW - ABSORBED POWER**

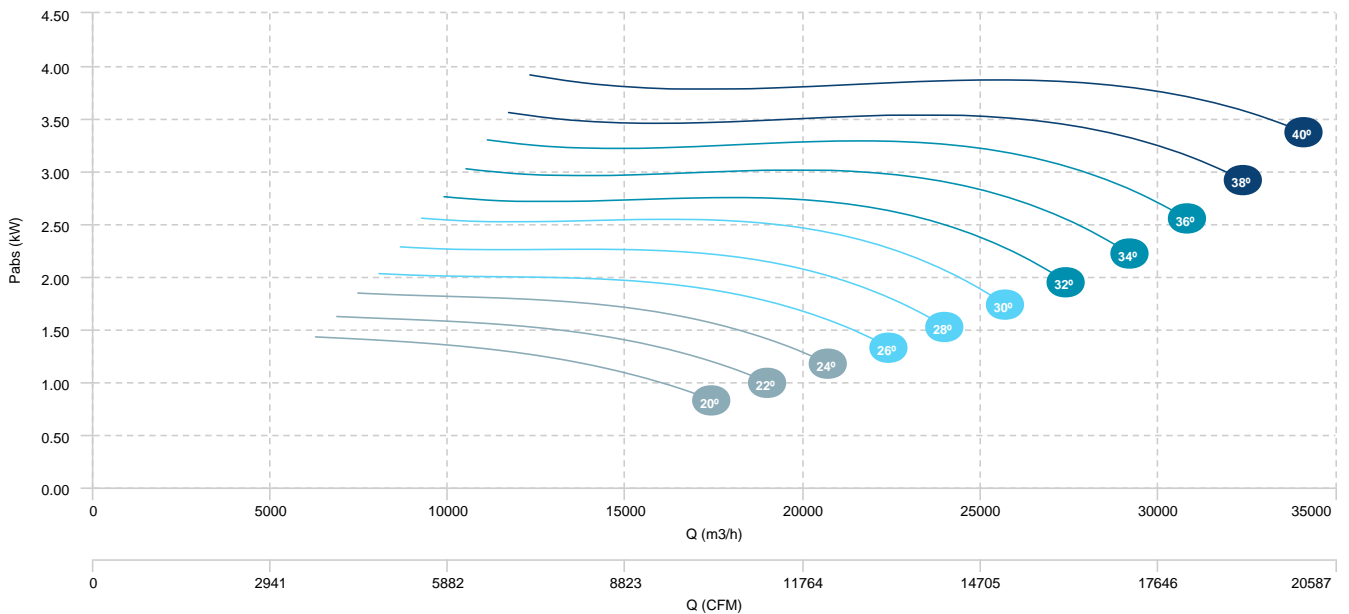

BOX HBF 90 T6 1,5kW (A3:4) F400

BOX HBF 90 T6 2,2kW (A3:4) F400

AIR FLOW - PRESSURE

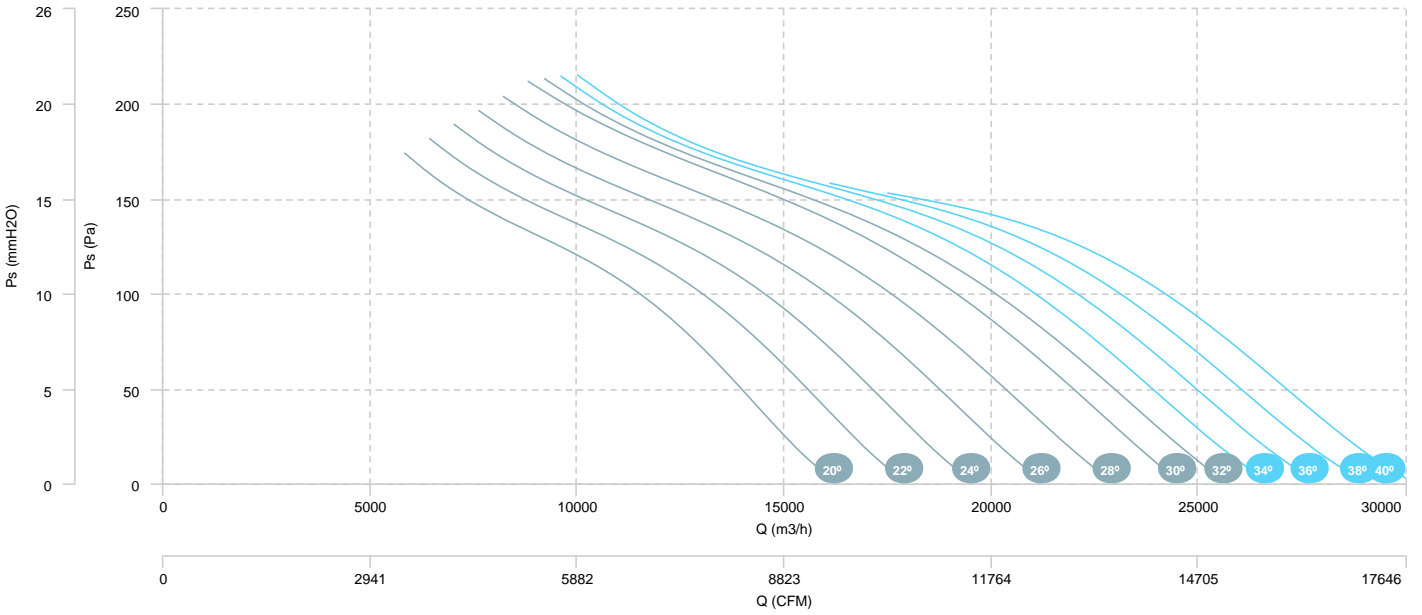

AIR FLOW - ABSORBED POWER

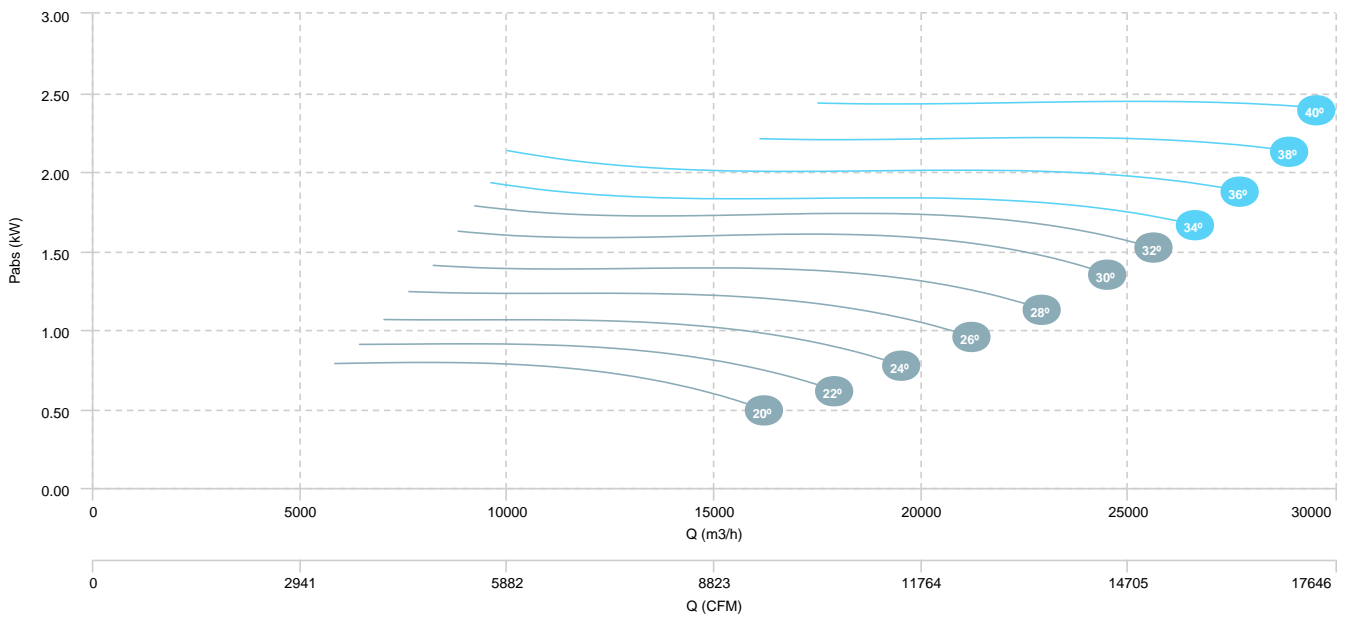

BOX HBF 90 T4/T8 5,5/1,1kW (A3:8)  
F400

BOX HBF 90 T4/T8 7,5/1,5kW (A3:8)  
F400

BOX HBF 90 T4/T8 11/3kW (A3:8) F400

BOX HBF 90 T4/T8 14/3,5kW (A3:8) F400

AIR FLOW - PRESSURE (4 poles)

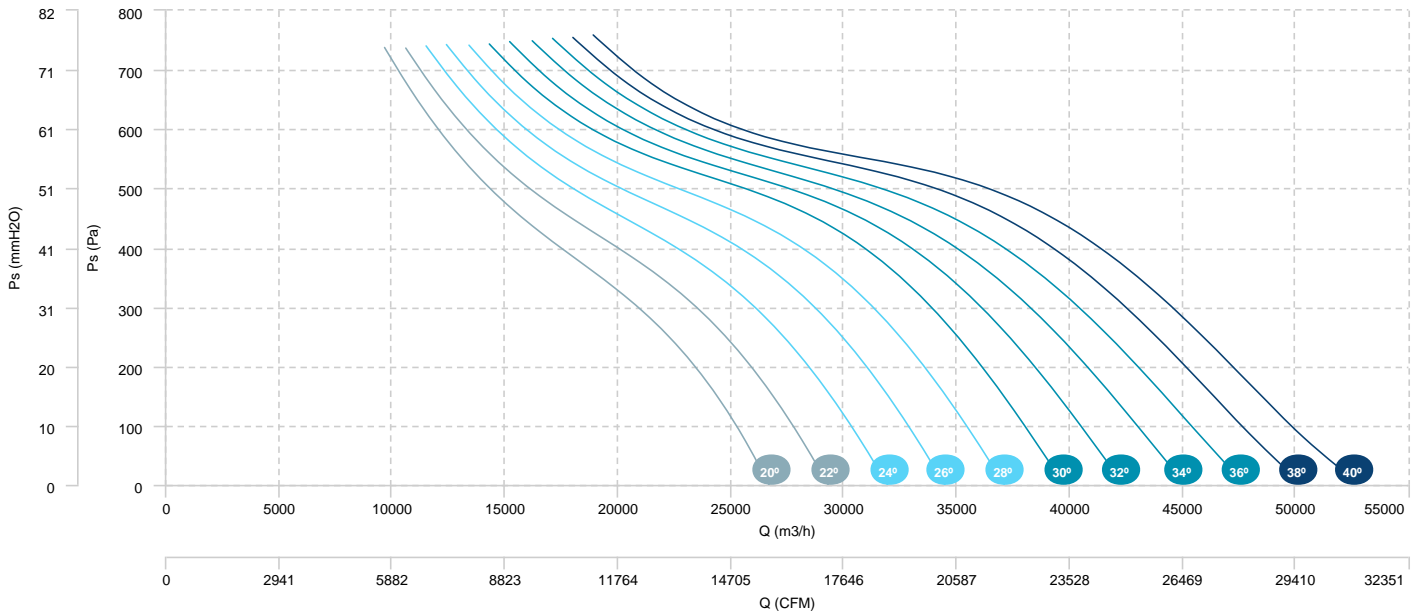

AIR FLOW - ABSORBED POWER (4 poles)

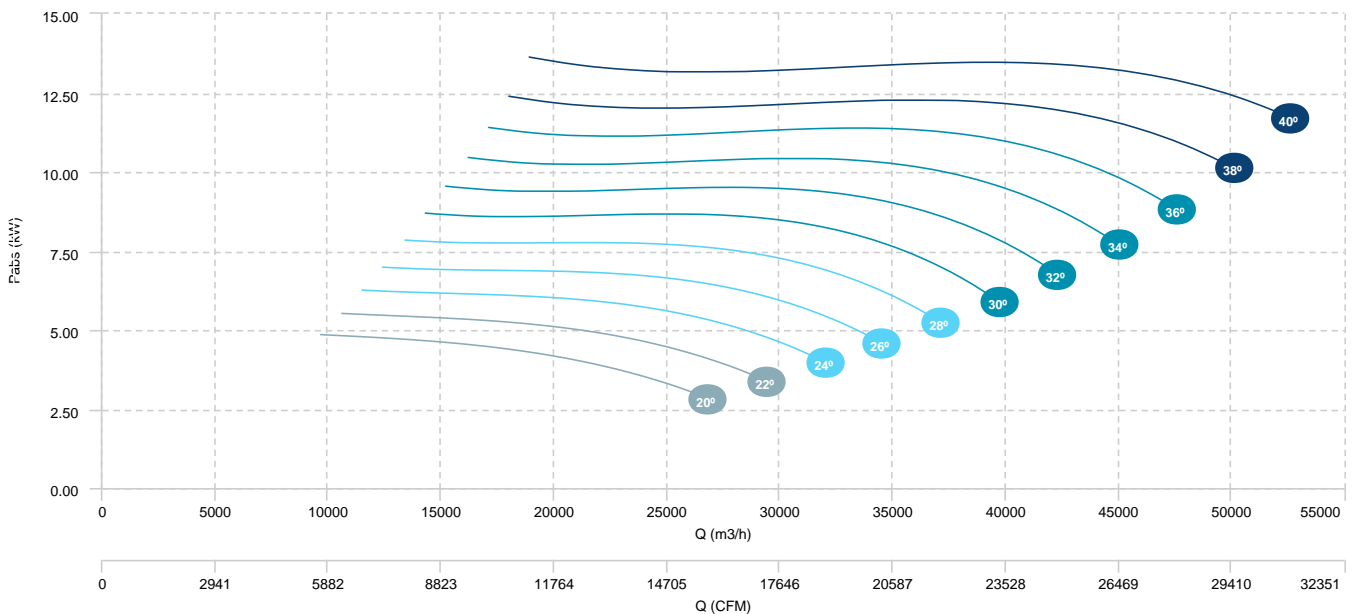



BOX HBF 90 T4/T8 5,5/1,1kW (A3:8) F400  
 BOX HBF 90 T4/T8 14/3,5kW (A3:8) F400

BOX HBF 90 T4/T8 7,5/1,5kW (A3:8) F400

BOX HBF 90 T4/T8 11/3kW (A3:8) F400

AIR FLOW - PRESSURE (8 poles)

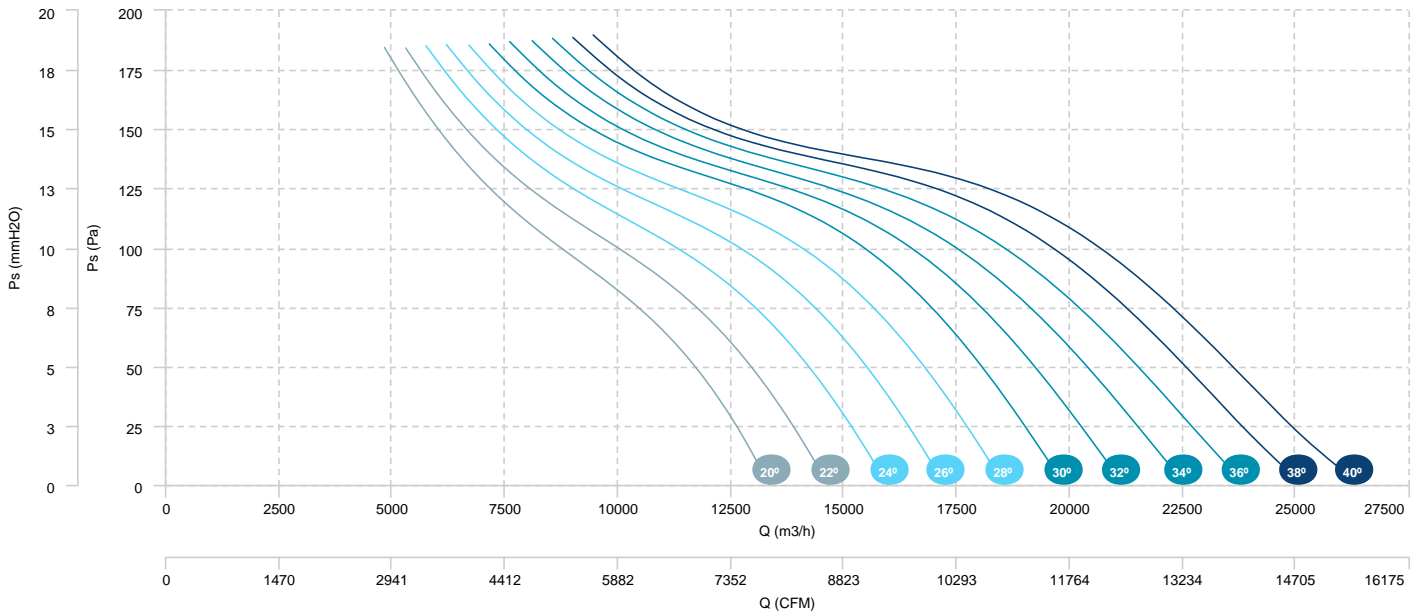

BOX HBF 90 T4/T8 2,8/0,7kW (A3:4) F400	BOX HBF 90 T4/T8 4/0,75kW (A3:4) F400	BOX HBF 90 T4/T8 5,5/1,1kW (A3:4) F400
BOX HBF 90 T4/T8 7,5/1,5kW (A3:4) F400	BOX HBF 90 T4/T8 11/3kW (A3:4) F400	

AIR FLOW - PRESSURE (4 poles)

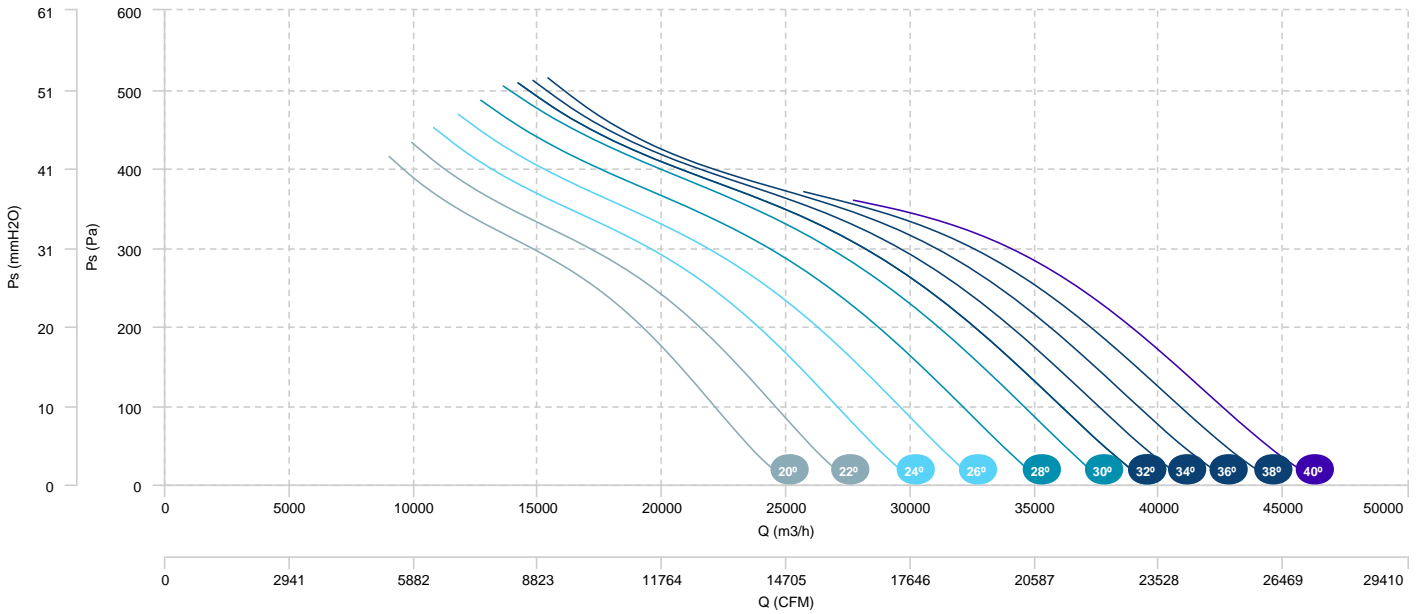

AIR FLOW - ABSORBED POWER (4 poles)

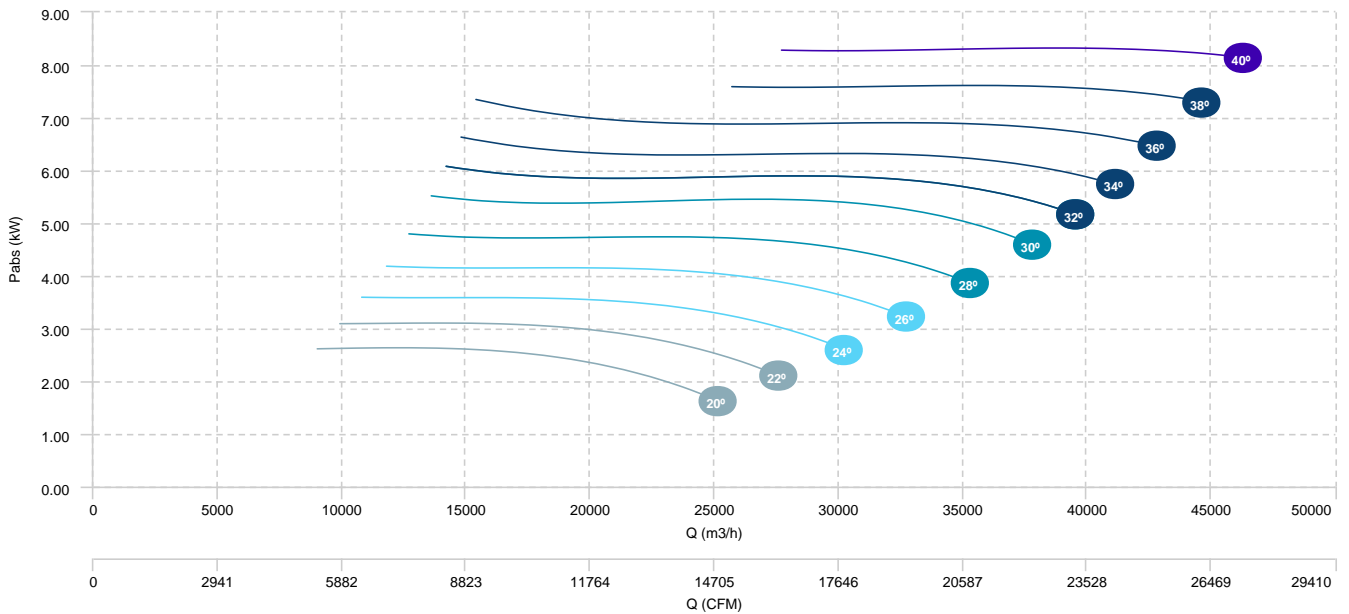

BOX HBF 90 T4/T8 2,8/0,7kW (A3:4) F400	BOX HBF 90 T4/T8 4/0,75kW (A3:4) F400	BOX HBF 90 T4/T8 5,5/1,1kW (A3:4) F400
BOX HBF 90 T4/T8 7,5/1,5kW (A3:4) F400	BOX HBF 90 T4/T8 11/3kW (A3:4) F400	

AIR FLOW - PRESSURE (8 poles)

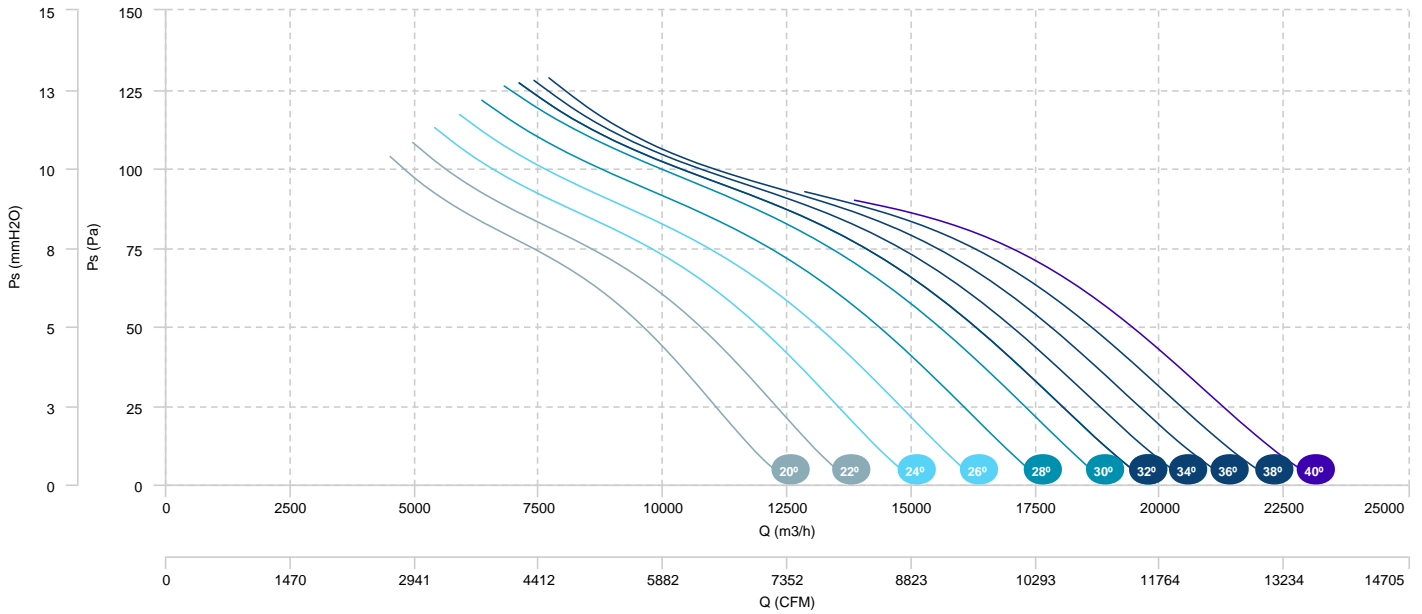

BOX HBF 100 T4 7,5kW (A3:8) F400	BOX HBF 100 T4 11kW (A3:8) F400	BOX HBF 100 T4 15kW (A3:8) F400
BOX HBF 100 T4 18,5kW (A3:8) F400	BOX HBF 100 T4 22kW (A3:8) F400	

AIR FLOW - PRESSURE

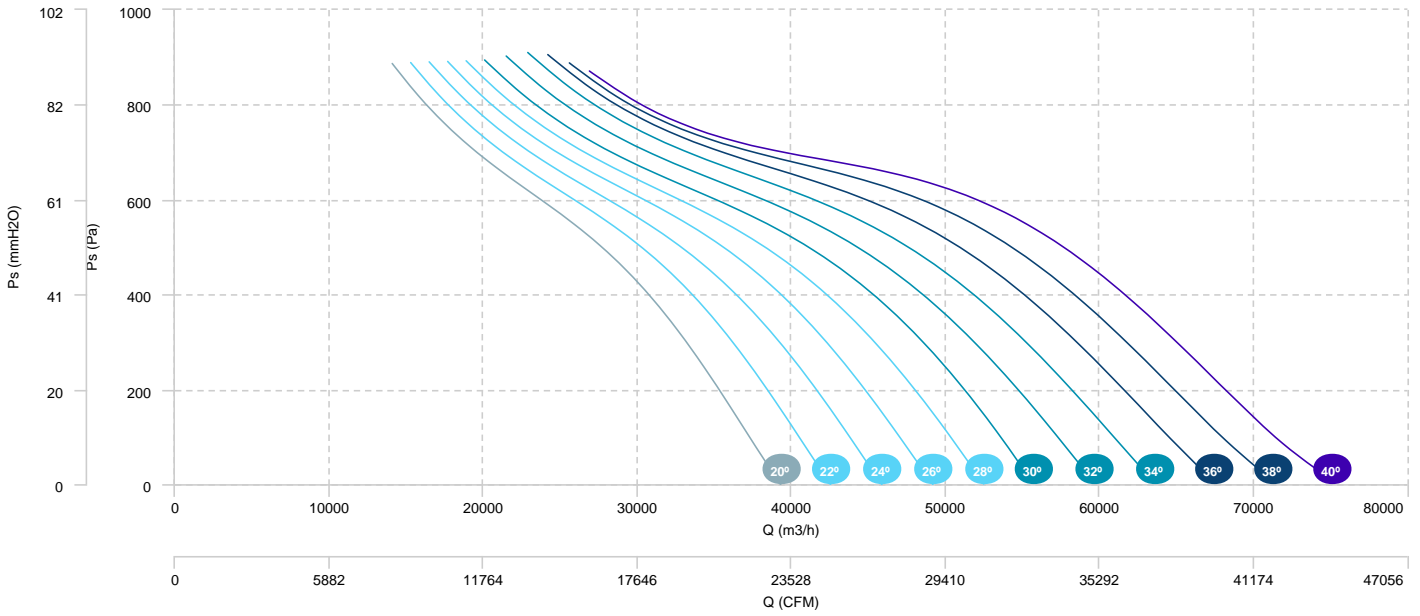

AIR FLOW - ABSORBED POWER

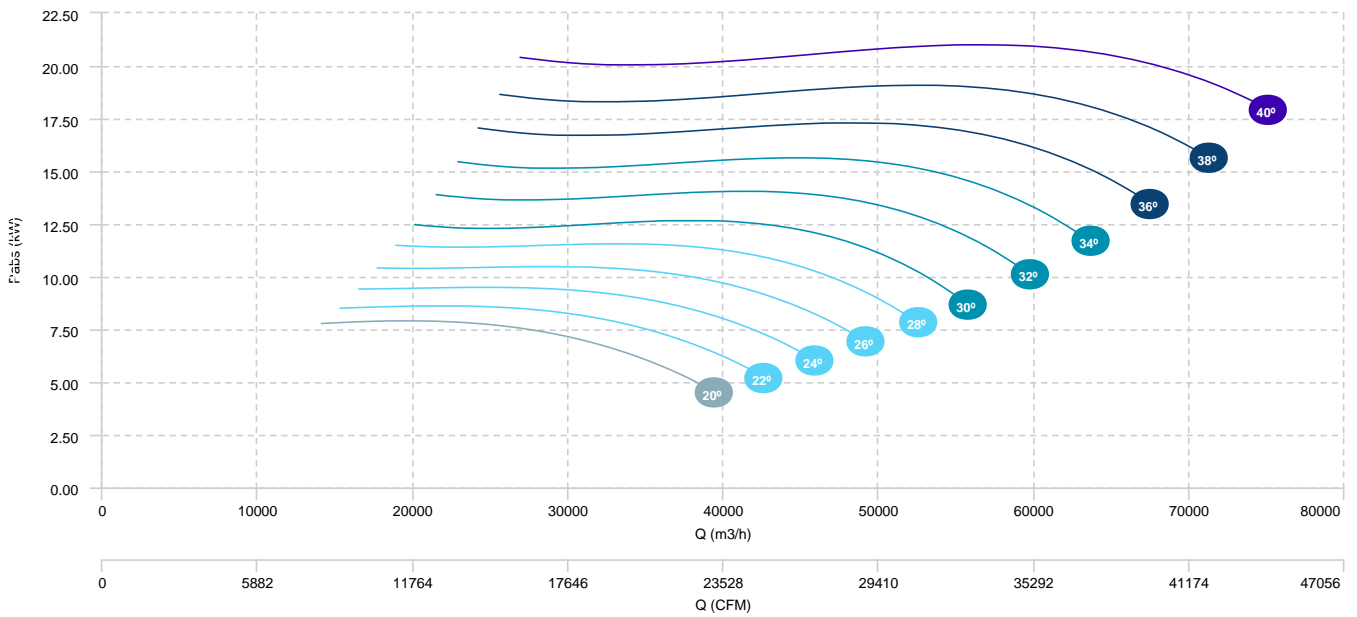

- BOX HBF 100 T4 5,5kW (A3:4) F400
- BOX HBF 100 T4 7,5kW (A3:4) F400
- BOX HBF 100 T4 11kW (A3:4) F400
- BOX HBF 100 T4 15kW (A3:4) F400

**AIR FLOW - PRESSURE**

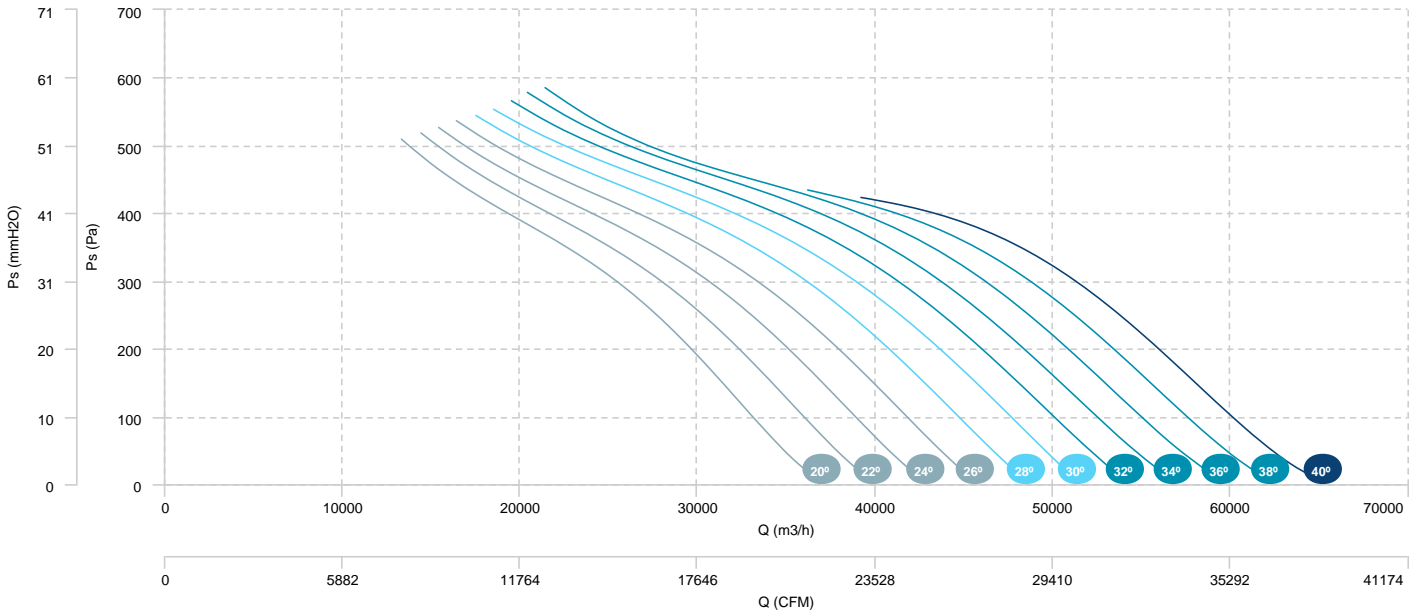

**AIR FLOW - ABSORBED POWER**

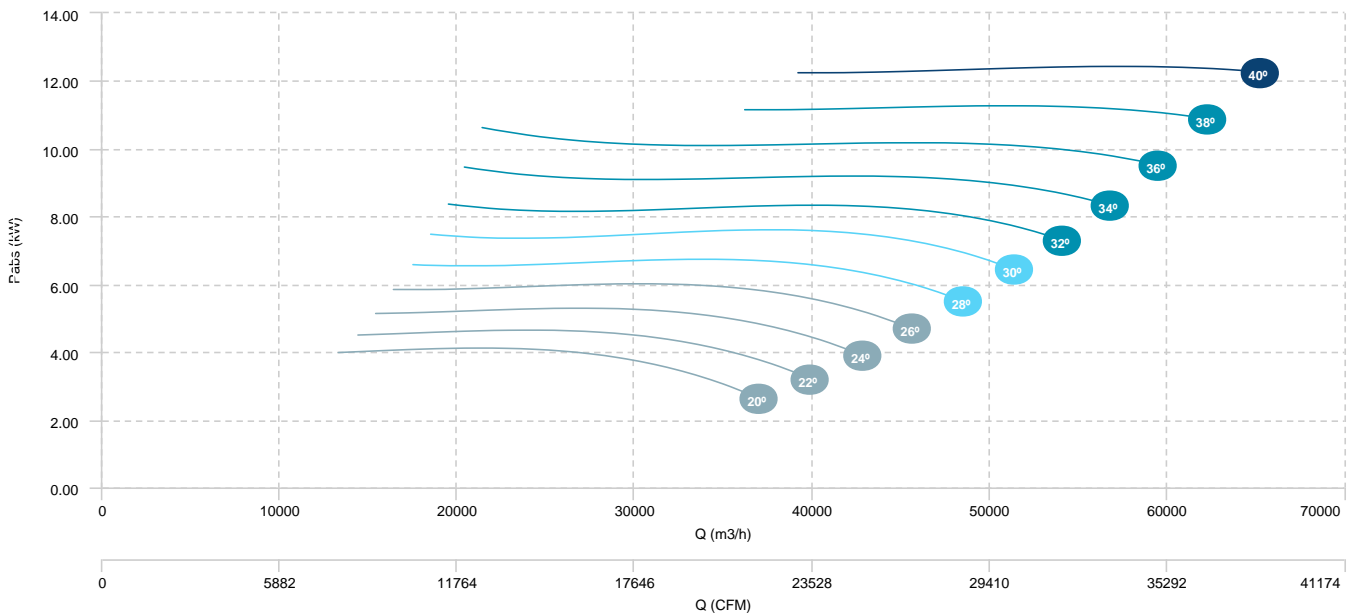

BOX HBF 100 T6 2,2kW (A3:8) F400

BOX HBF 100 T6 3kW (A3:8) F400

BOX HBF 100 T6 4kW (A3:8) F400

BOX HBF 100 T6 5,5kW (A3:8) F400

AIR FLOW - PRESSURE

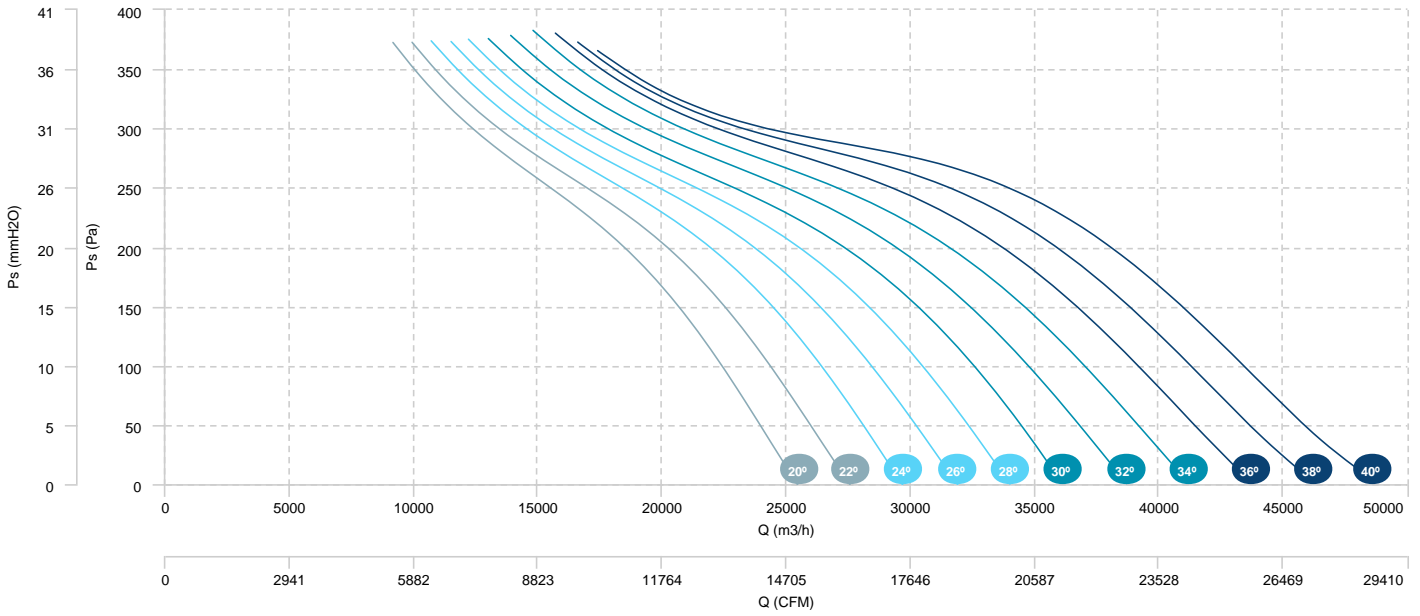

AIR FLOW - ABSORBED POWER

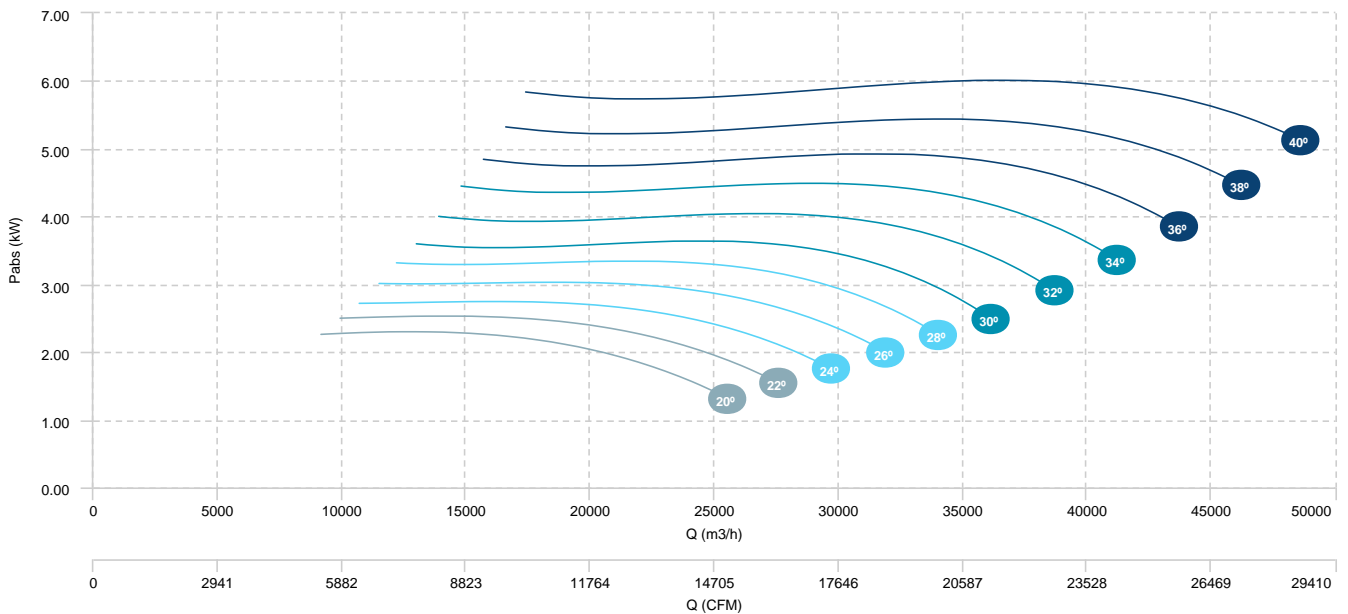

- BOX HBF 100 T6 1,5kW (A3:4) F400
- BOX HBF 100 T6 2,2kW (A3:4) F400
- BOX HBF 100 T6 3kW (A3:4) F400
- BOX HBF 100 T6 4kW (A3:4) F400

**AIR FLOW - PRESSURE**

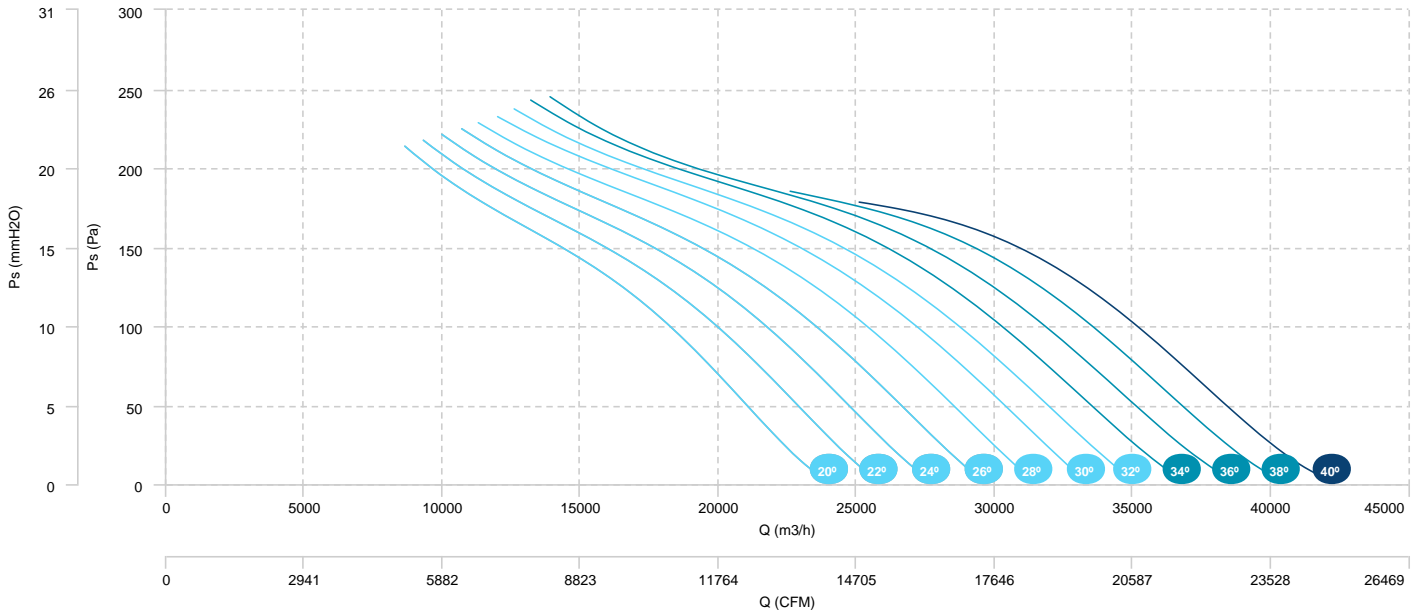

**AIR FLOW - ABSORBED POWER**

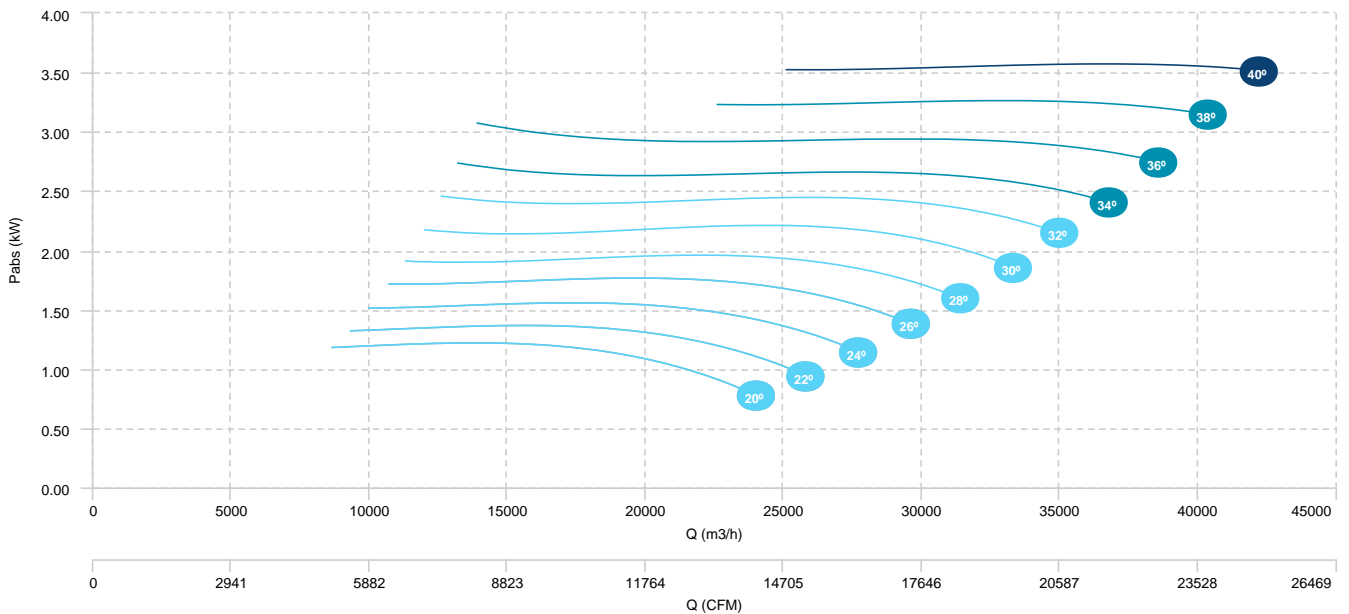

BOX HBF 100 T4/T8 7,5/1,5kW (A3:8) F400	BOX HBF 100 T4/T8 11/3kW (A3:8) F400	BOX HBF 100 T4/T8 14/3,5kW (A3:8) F400
BOX HBF 100 T4/T8 17/4,3kW (A3:8) F400	BOX HBF 100 T4/T8 20/5kW (A3:8) F400	

AIR FLOW - PRESSURE (4 poles)

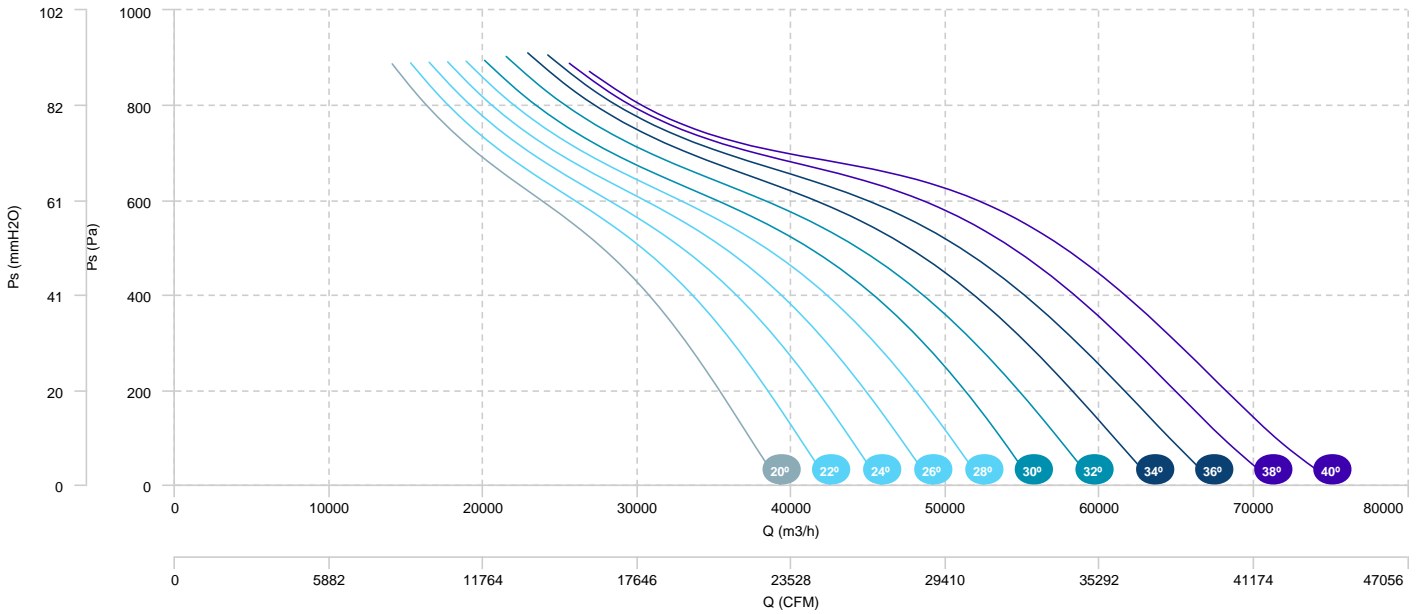

AIR FLOW - ABSORBED POWER (4 poles)

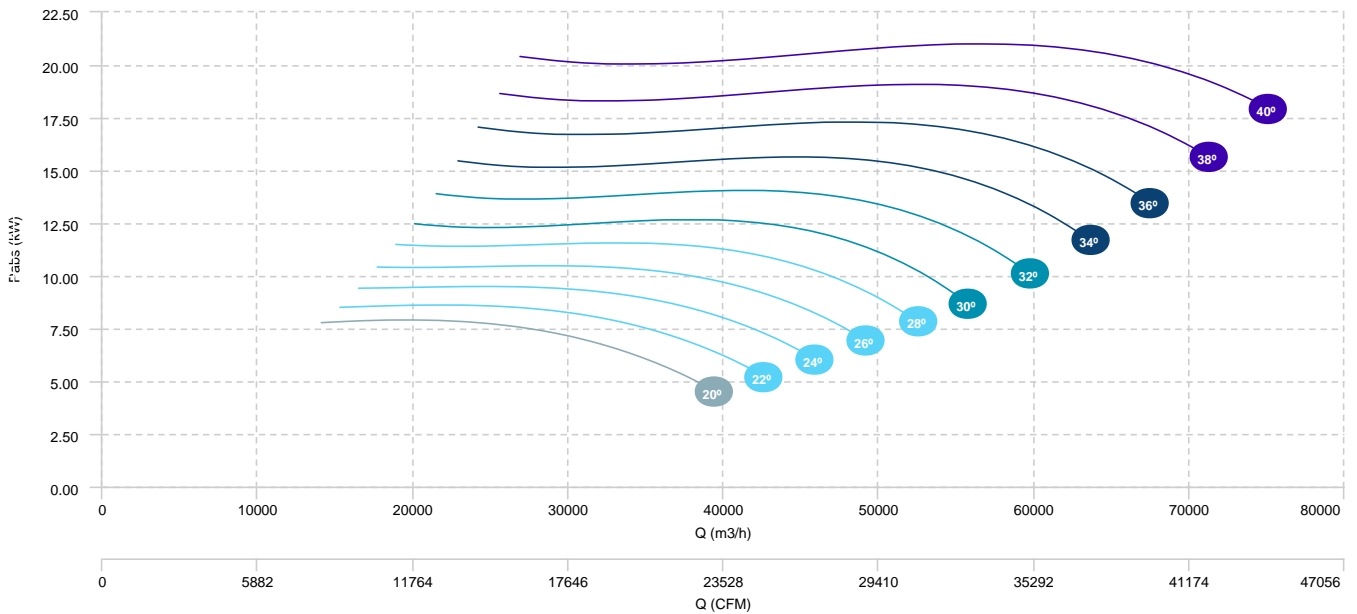



BOX HBF 100 T4/T8 7,5/1,5kW (A3:8) F400	BOX HBF 100 T4/T8 11/3kW (A3:8) F400	BOX HBF 100 T4/T8 14/3,5kW (A3:8) F400
BOX HBF 100 T4/T8 17/4,3kW (A3:8) F400	BOX HBF 100 T4/T8 20/5kW (A3:8) F400	

AIR FLOW - PRESSURE (8 poles)

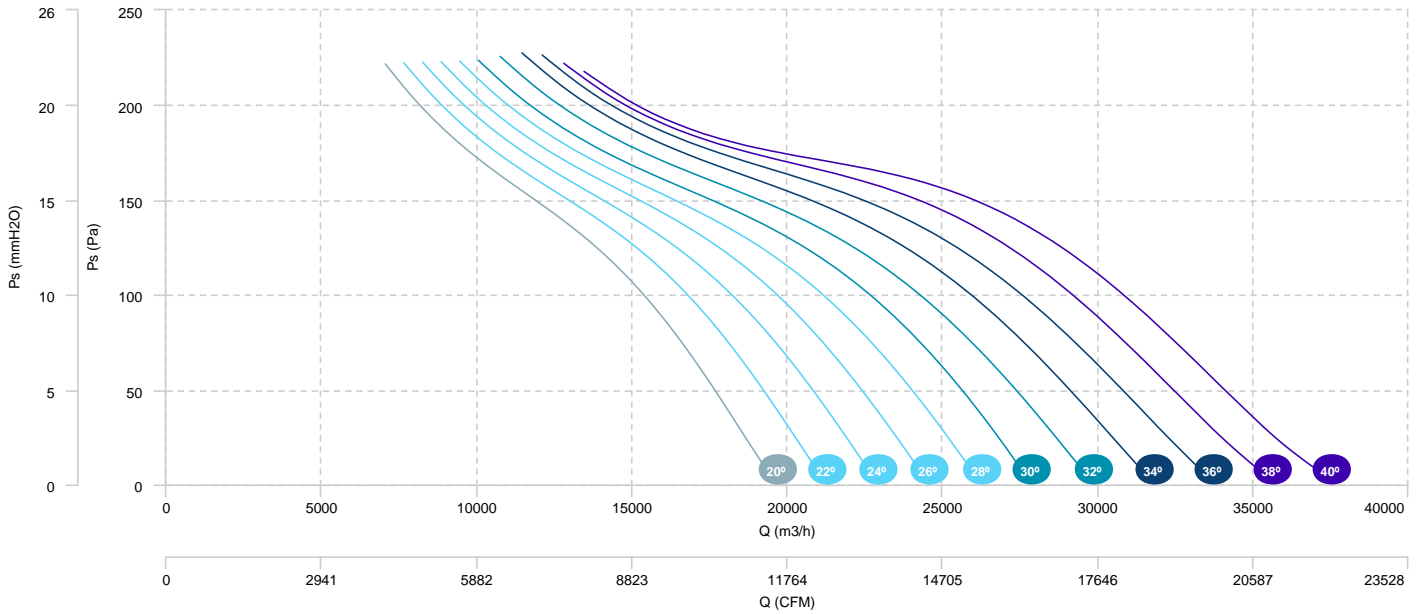

BOX HBF 100 T4/T8 5,5/1,1kW (A3:4)  
F400

BOX HBF 100 T4/T8 7,5/1,5kW (A3:4)  
F400

BOX HBF 100 T4/T8 11/3kW (A3:4) F400

BOX HBF 100 T4/T8 14/3,5kW (A3:4)  
F400

AIR FLOW - PRESSURE (4 poles)

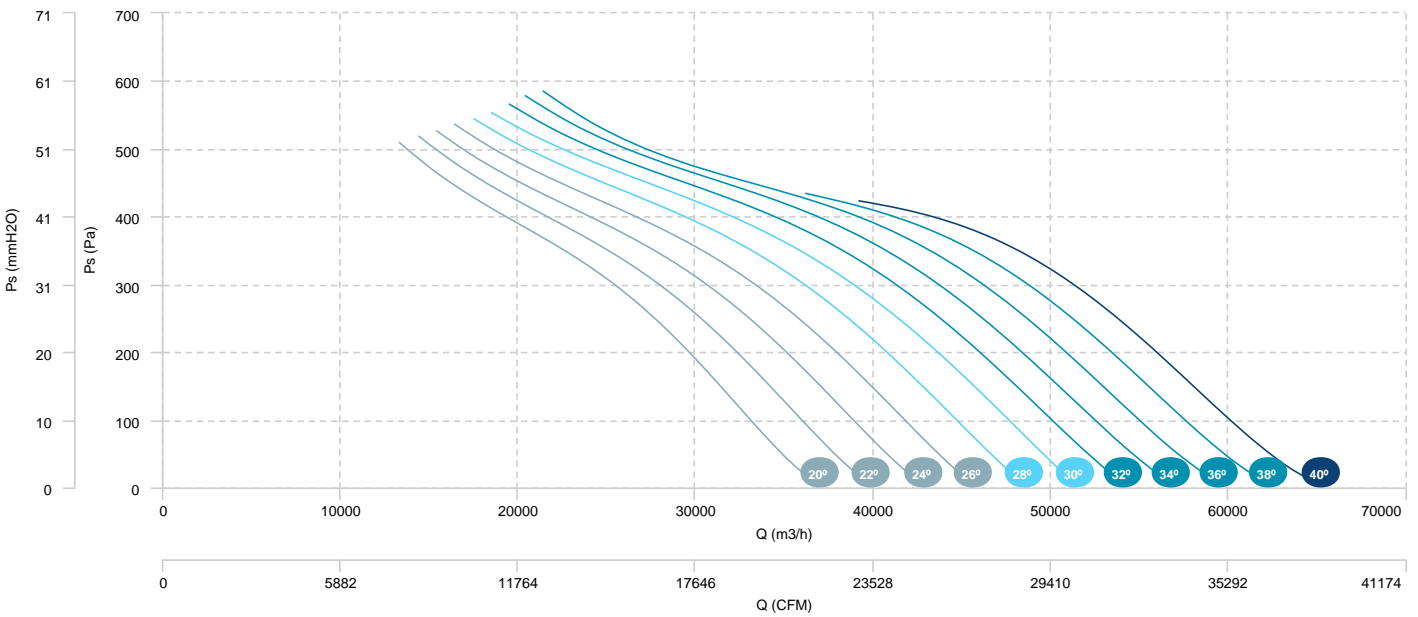

AIR FLOW - ABSORBED POWER (4 poles)

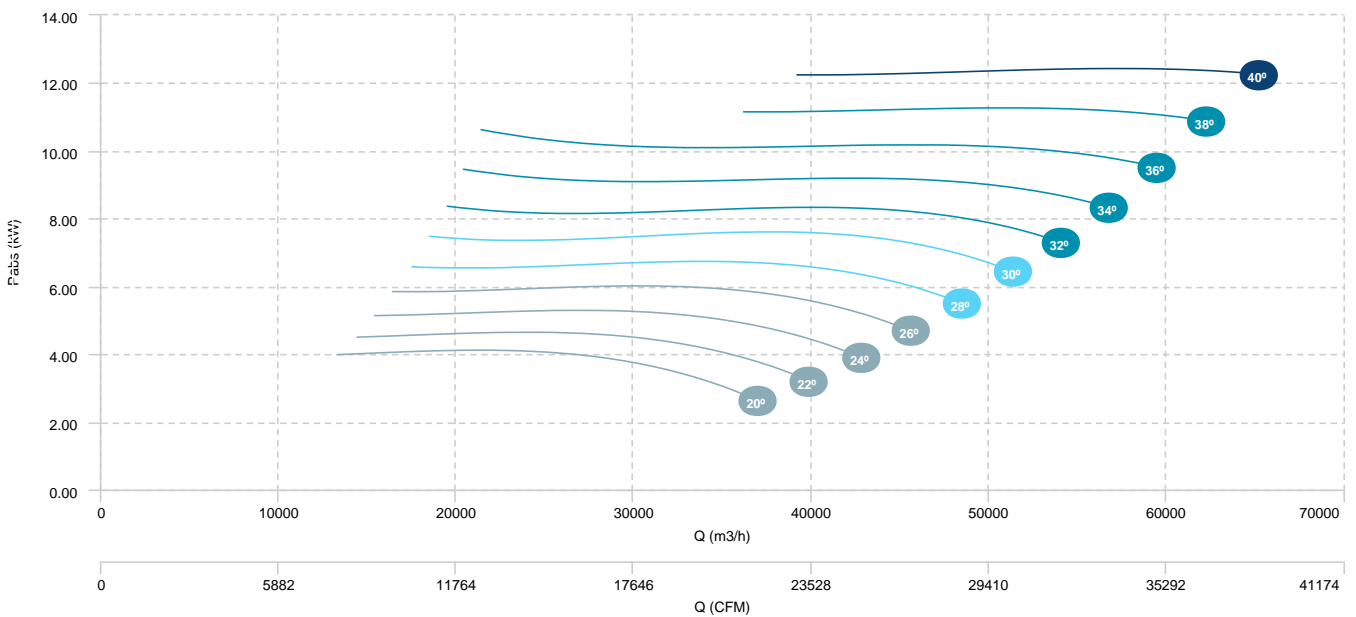

BOX HBF 100 T4/T8 5,5/1,1kW (A3:4)  
F400

BOX HBF 100 T4/T8 7,5/1,5kW (A3:4)  
F400

BOX HBF 100 T4/T8 11/3kW (A3:4) F400

BOX HBF 100 T4/T8 14/3,5kW (A3:4)  
F400

AIR FLOW - PRESSURE (8 poles)

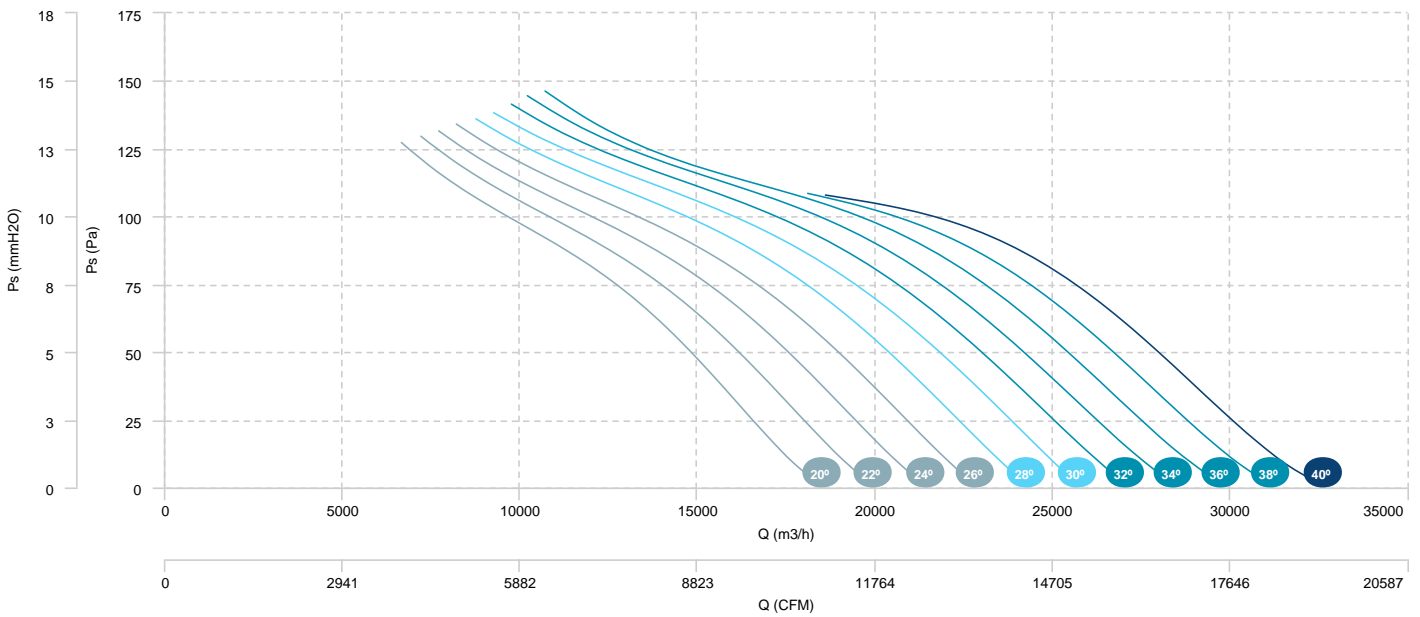

BOX HBF 112 T4 11kW (A3:8) F400	BOX HBF 112 T4 15kW (A3:8) F400	BOX HBF 112 T4 18,5kW (A3:8) F400
BOX HBF 112 T4 22kW (A3:8) F400	BOX HBF 112 T4 30kW (A3:8) F400	

AIR FLOW - PRESSURE

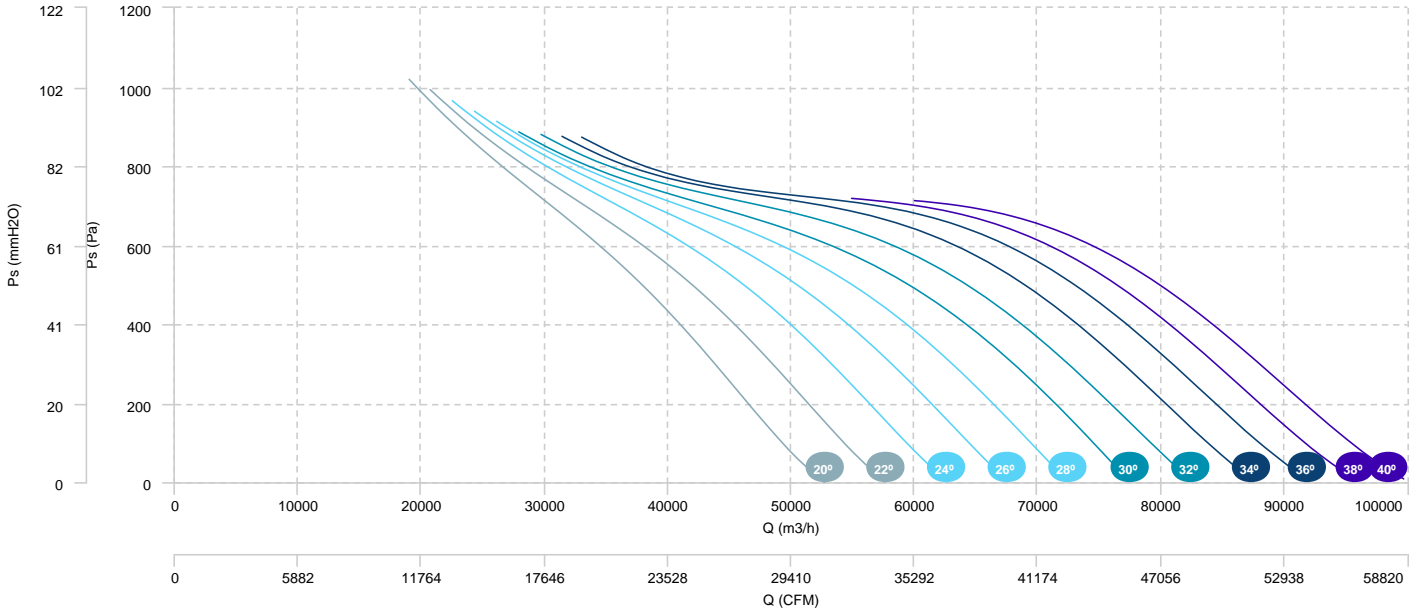

AIR FLOW - ABSORBED POWER

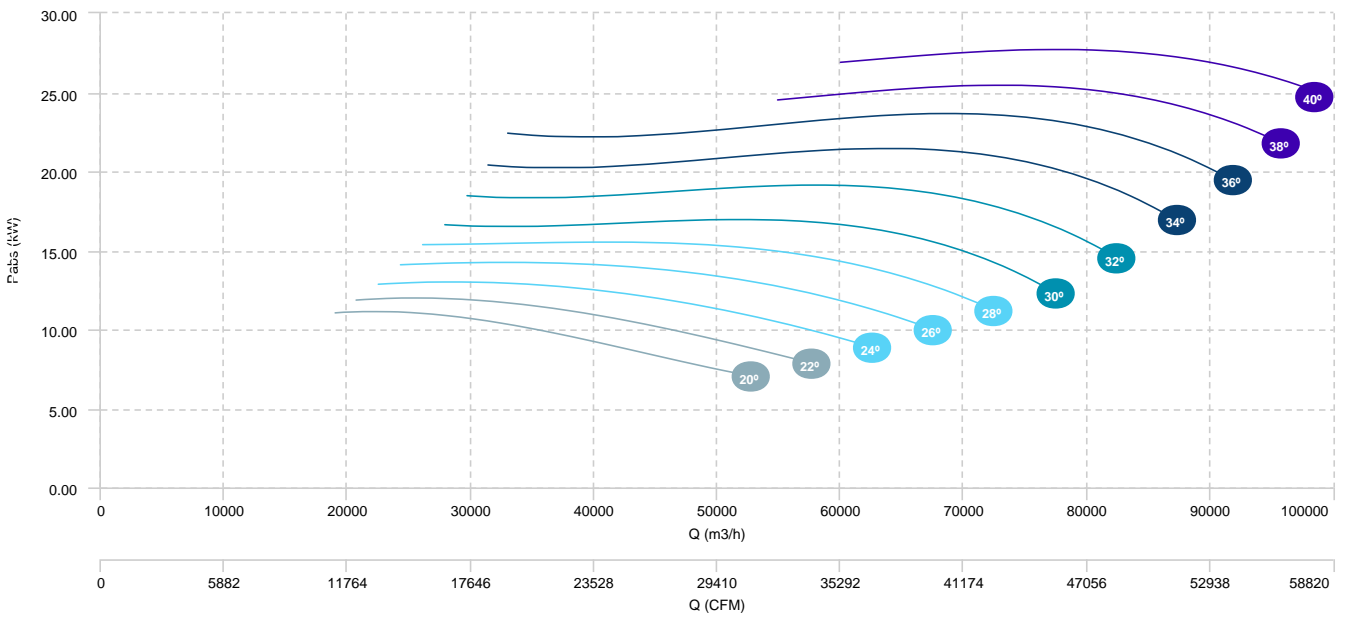

BOX HBF 112 T4 5,5kW (A3:4) F400	BOX HBF 112 T4 7,5kW (A3:4) F400	BOX HBF 112 T4 11kW (A3:4) F400
BOX HBF 112 T4 15kW (A3:4) F400	BOX HBF 112 T4 18,5kW (A3:4) F400	

**AIR FLOW - PRESSURE**

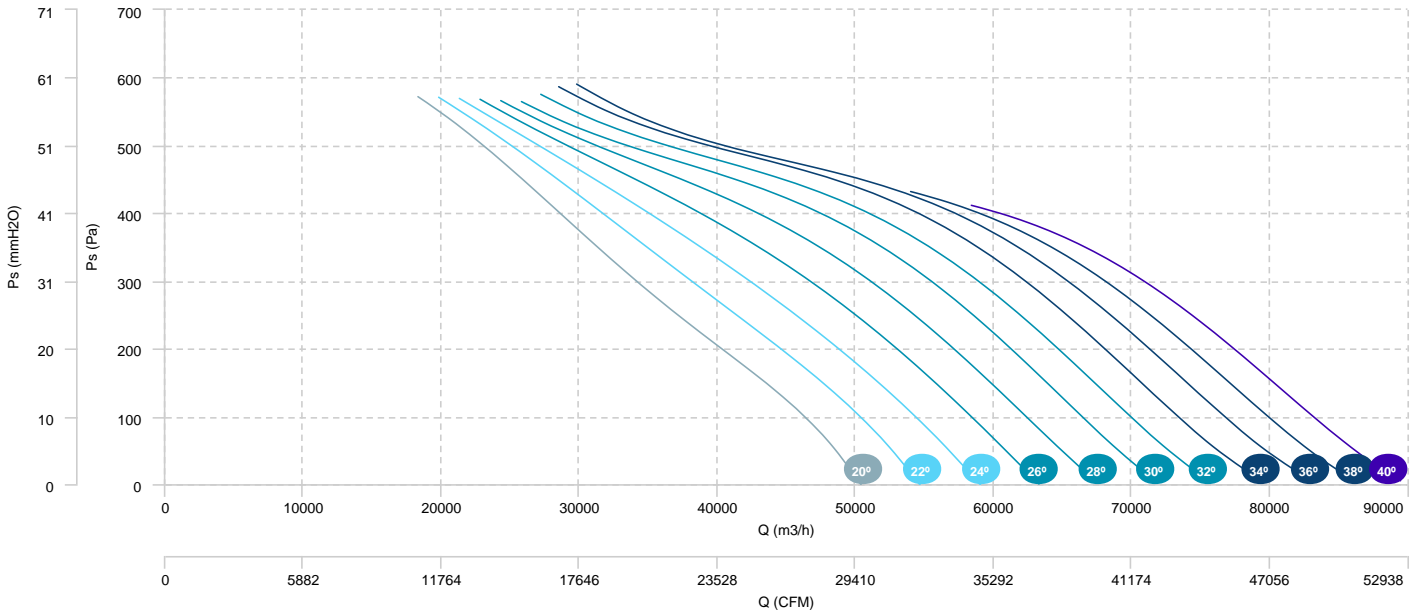

**AIR FLOW - ABSORBED POWER**

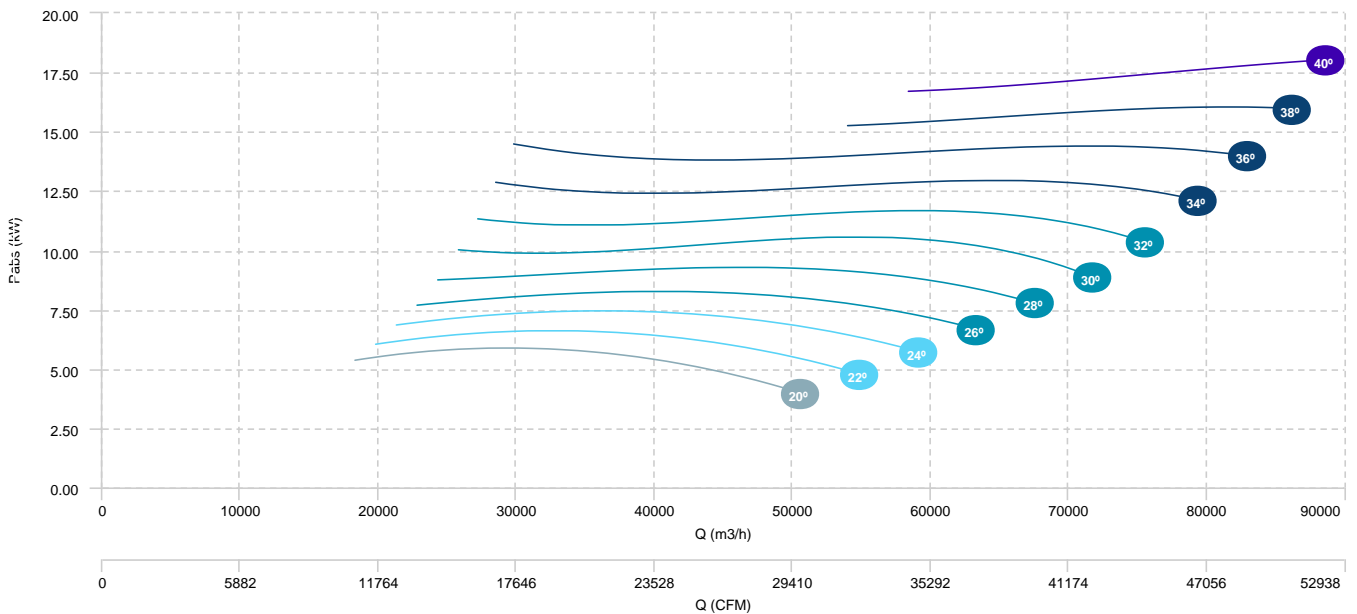

BOX HBF 112 T6 3kW (A3:8) F400

BOX HBF 112 T6 4kW (A3:8) F400

BOX HBF 112 T6 5,5kW (A3:8) F400

BOX HBF 112 T6 7,5kW (A3:8) F400

AIR FLOW - PRESSURE

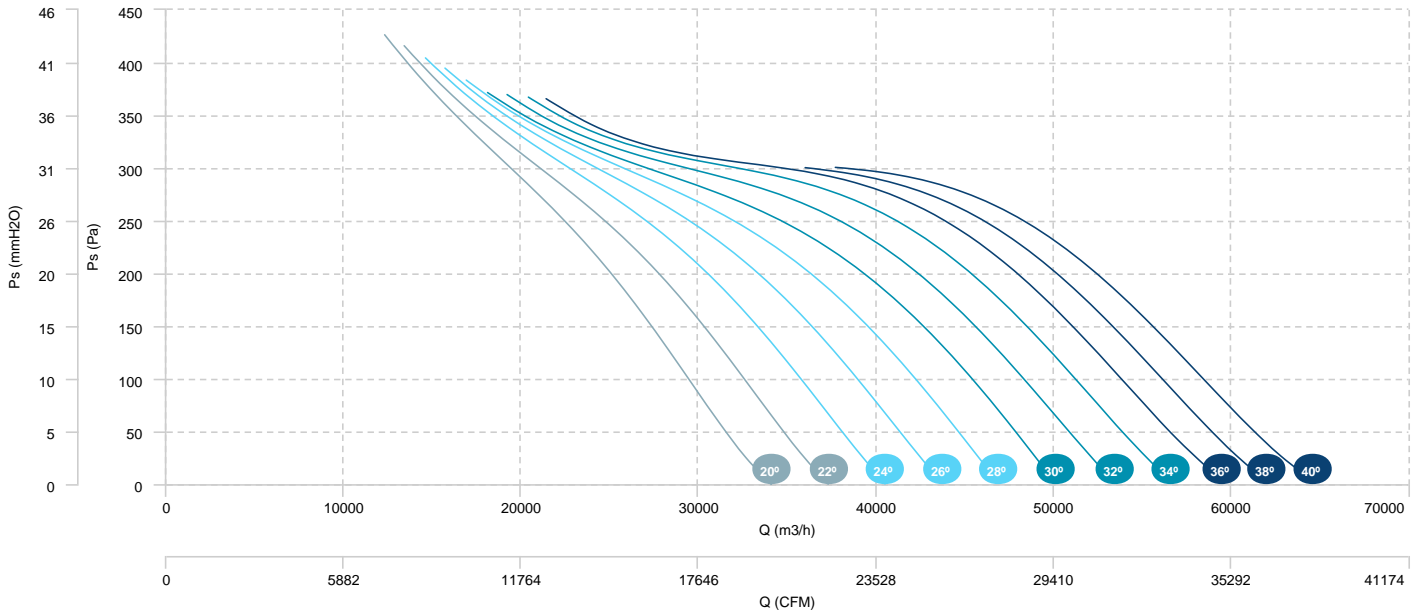

AIR FLOW - ABSORBED POWER

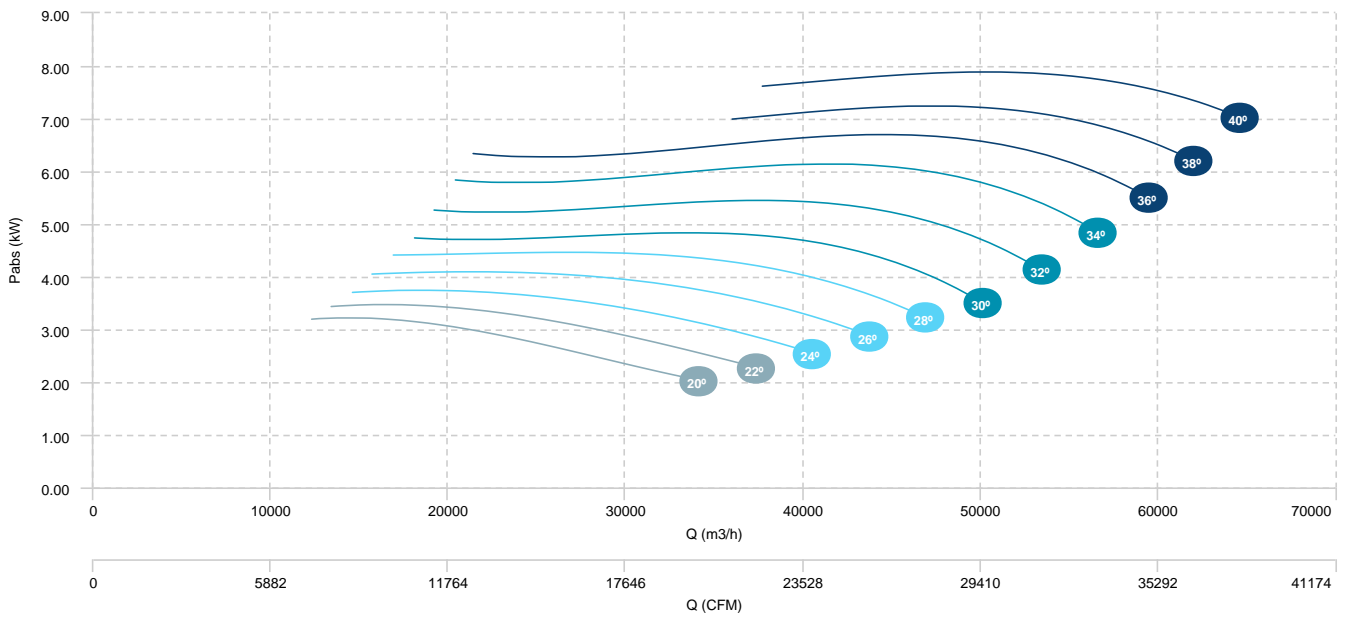

- BOX HBF 112 T6 2,2kW (A3:4) F400
  - BOX HBF 112 T6 3kW (A3:4) F400
  - BOX HBF 112 T6 4kW (A3:4) F400
- BOX HBF 112 T6 5,5kW (A3:4) F400

**AIR FLOW - PRESSURE**

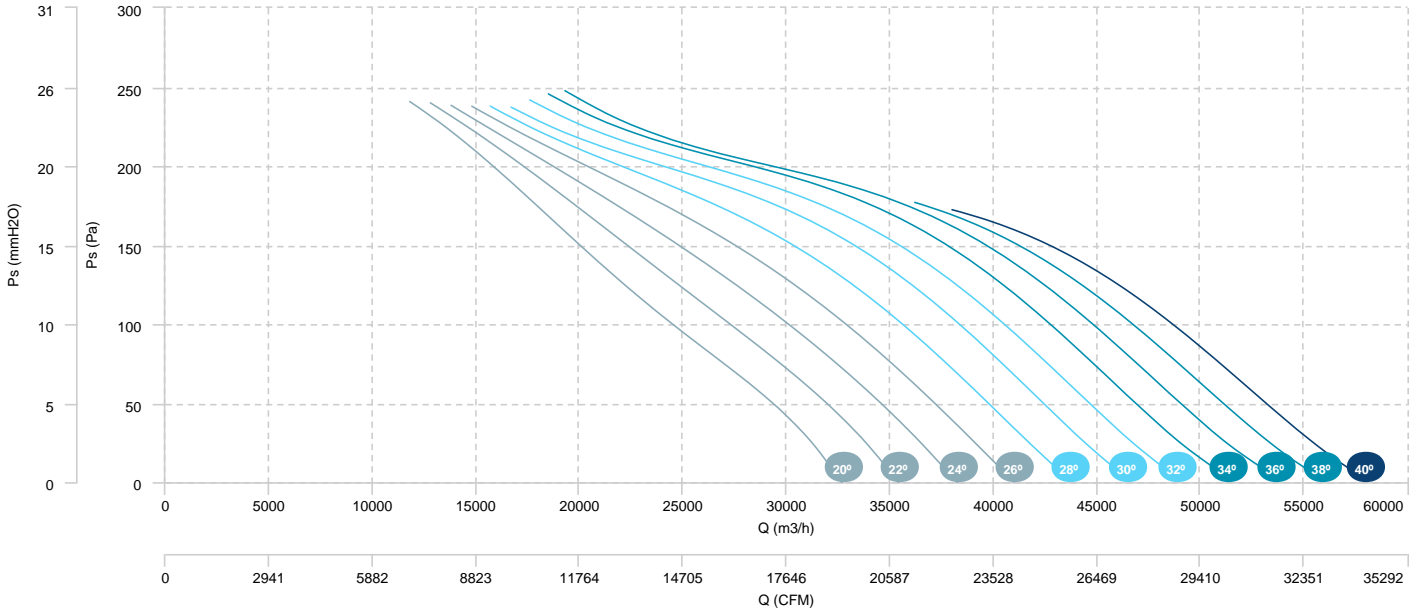

**AIR FLOW - ABSORBED POWER**

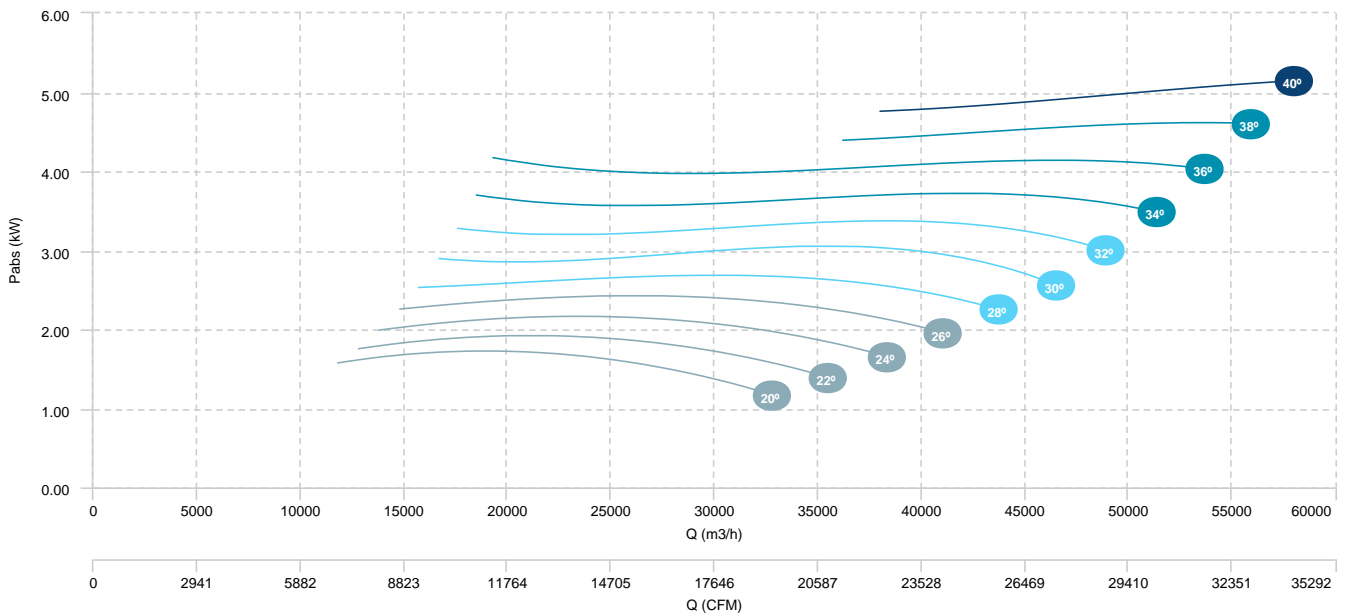

BOX HBF 112 T4/T8 11/3kW (A3:8) F400	BOX HBF 112 T4/T8 14/3,5kW (A3:8) F400	BOX HBF 112 T4/T8 17/4,3kW (A3:8) F400
BOX HBF 112 T4/T8 20/5kW (A3:8) F400	BOX HBF 112 T4/T8 28/6,5kW (A3:8) F400	

AIR FLOW - PRESSURE (4 poles)

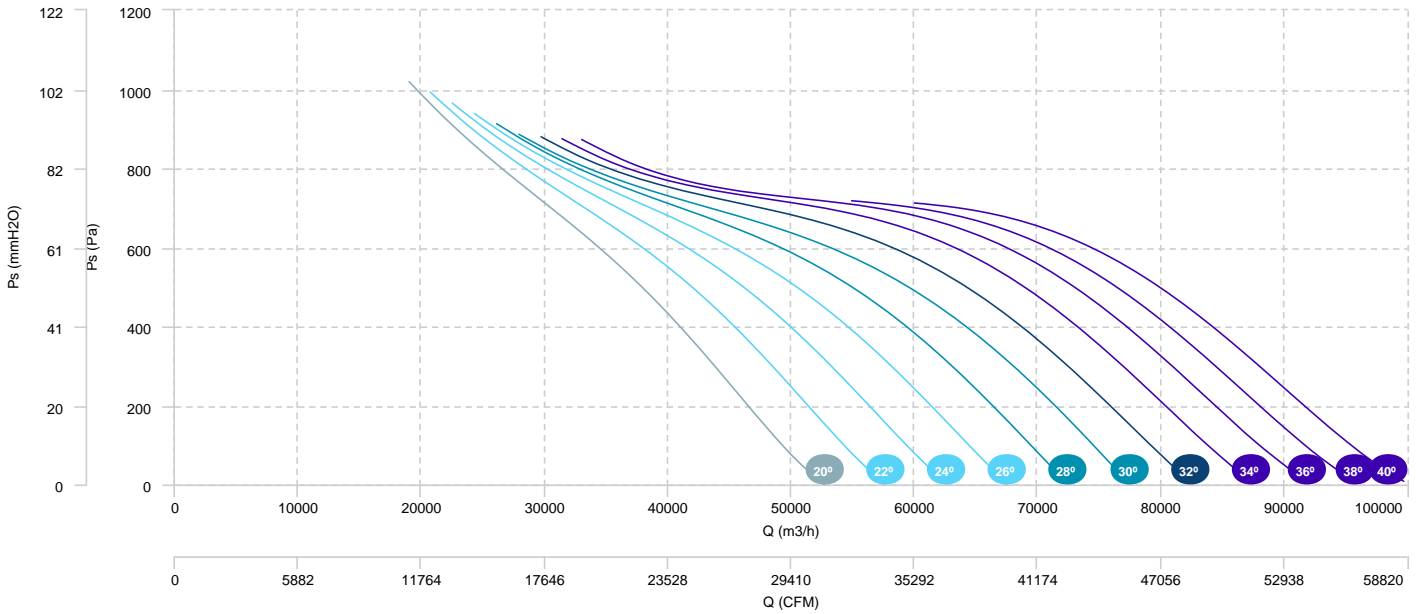

AIR FLOW - ABSORBED POWER (4 poles)

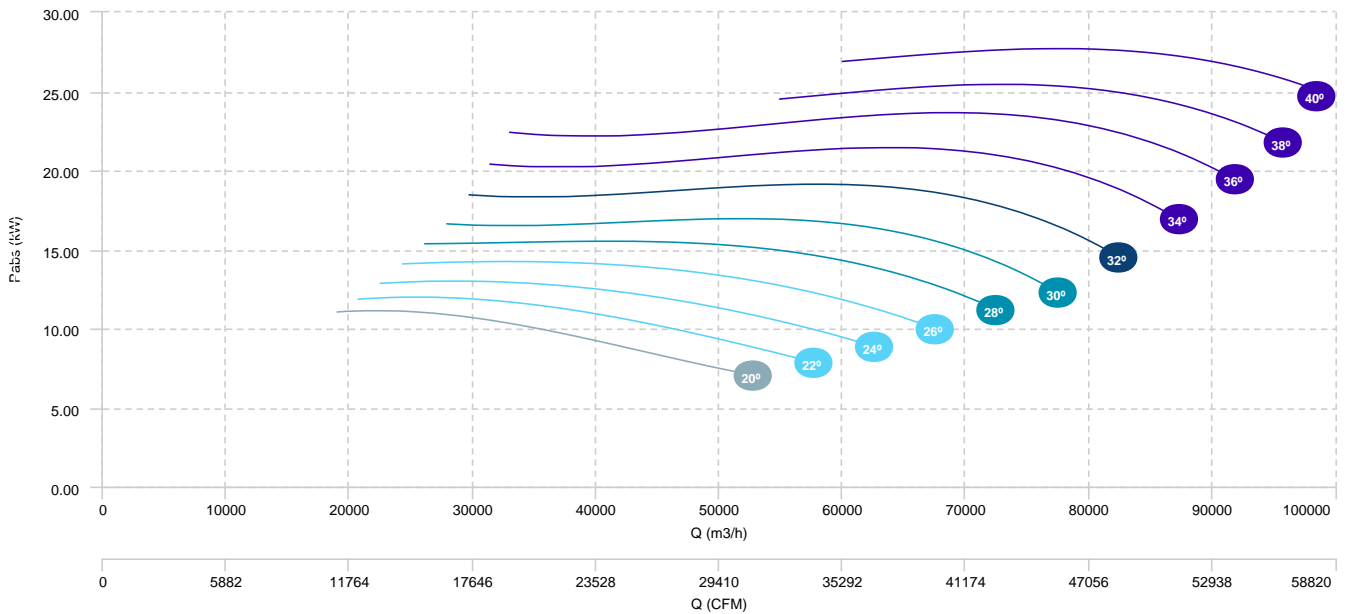



BOX HBF 112 T4/T8 11/3kW (A3:8) F400	BOX HBF 112 T4/T8 14/3,5kW (A3:8) F400	BOX HBF 112 T4/T8 17/4,3kW (A3:8) F400
BOX HBF 112 T4/T8 20/5kW (A3:8) F400	BOX HBF 112 T4/T8 28/6,5kW (A3:8) F400	

AIR FLOW - PRESSURE (8 poles)

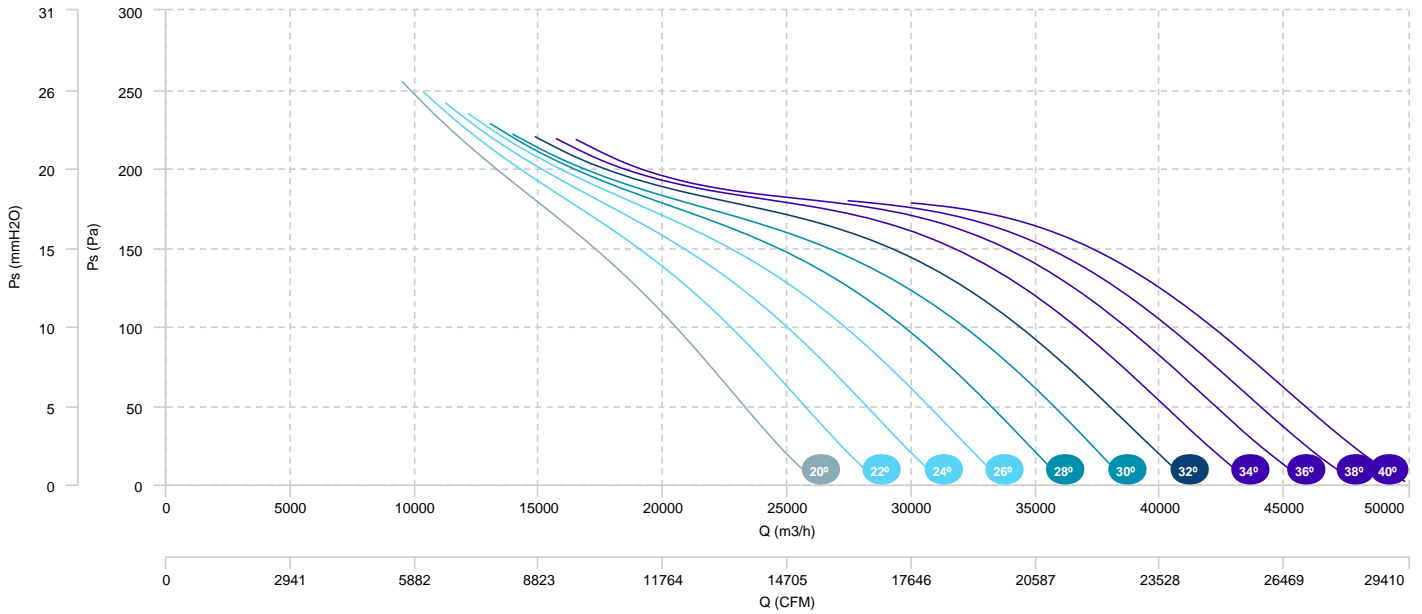

BOX HBF 112 T4/T8 5,5/1,1kW (A3:4) F400	BOX HBF 112 T4/T8 7,5/1,5kW (A3:4) F400	BOX HBF 112 T4/T8 11/3kW (A3:4) F400
BOX HBF 112 T4/T8 14/3,5kW (A3:4) F400	BOX HBF 112 T4/T8 17/4,3kW (A3:4) F400	

AIR FLOW - PRESSURE (4 poles)

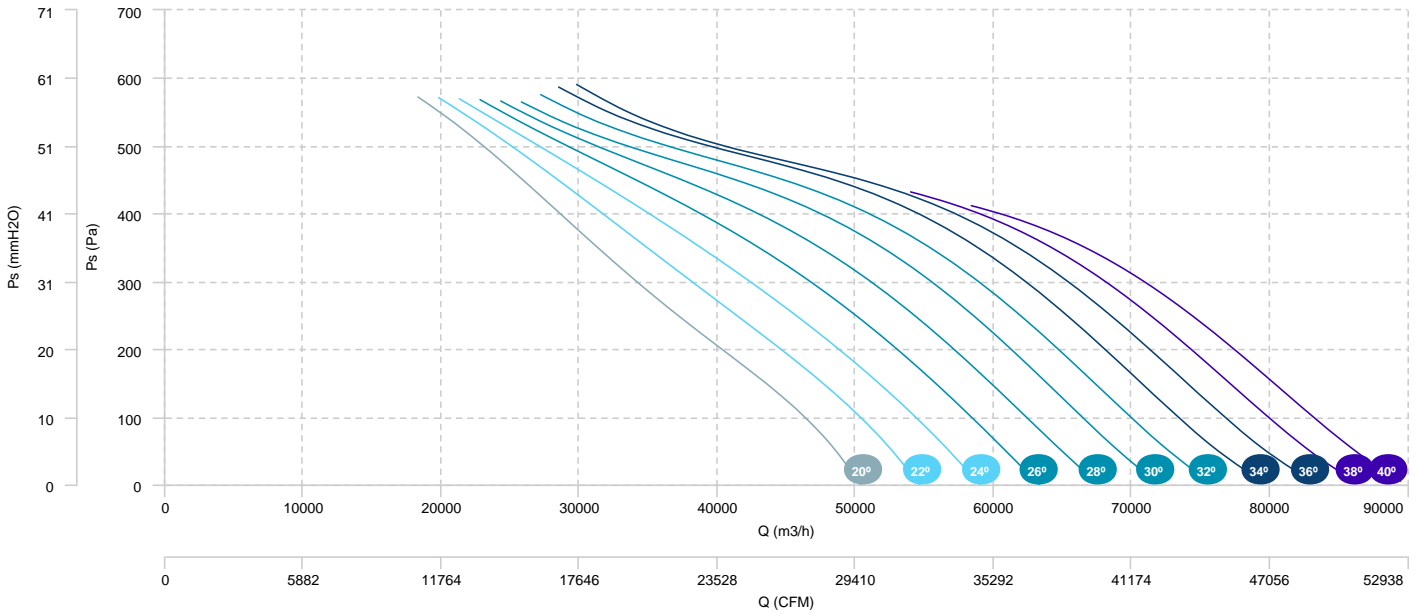

AIR FLOW - ABSORBED POWER (4 poles)

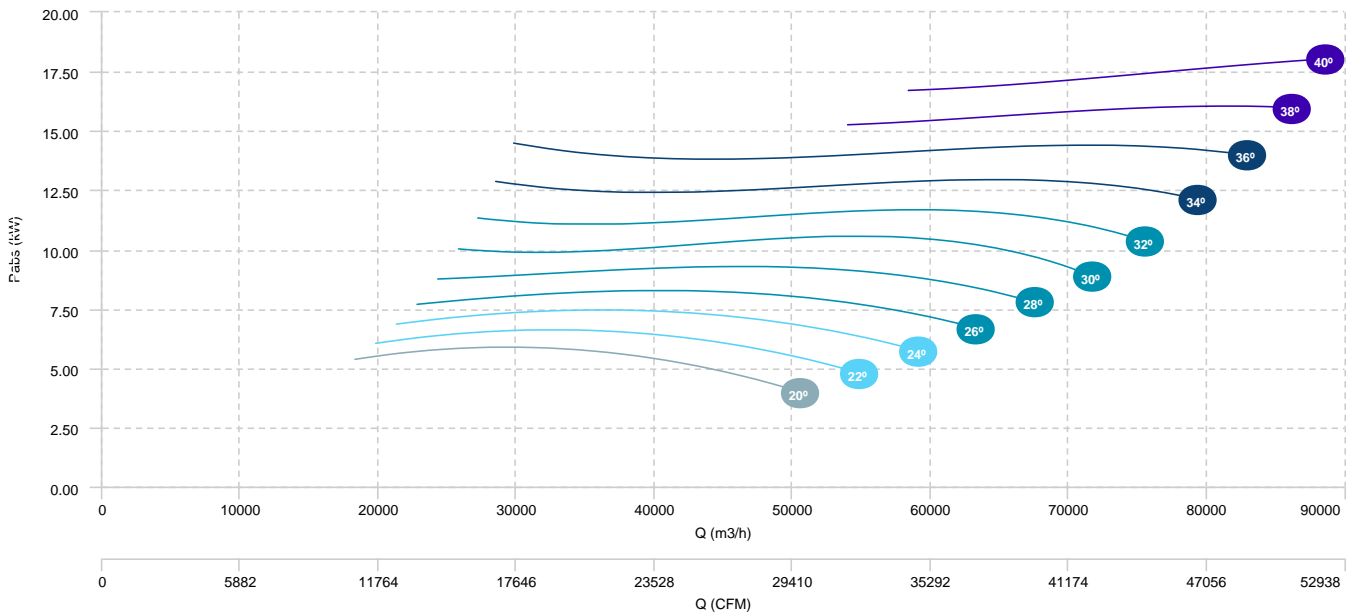

BOX HBF 112 T4/T8 5,5/1,1kW (A3:4) F400	BOX HBF 112 T4/T8 7,5/1,5kW (A3:4) F400	BOX HBF 112 T4/T8 11/3kW (A3:4) F400
BOX HBF 112 T4/T8 14/3,5kW (A3:4) F400	BOX HBF 112 T4/T8 17/4,3kW (A3:4) F400	

AIR FLOW - PRESSURE (8 poles)

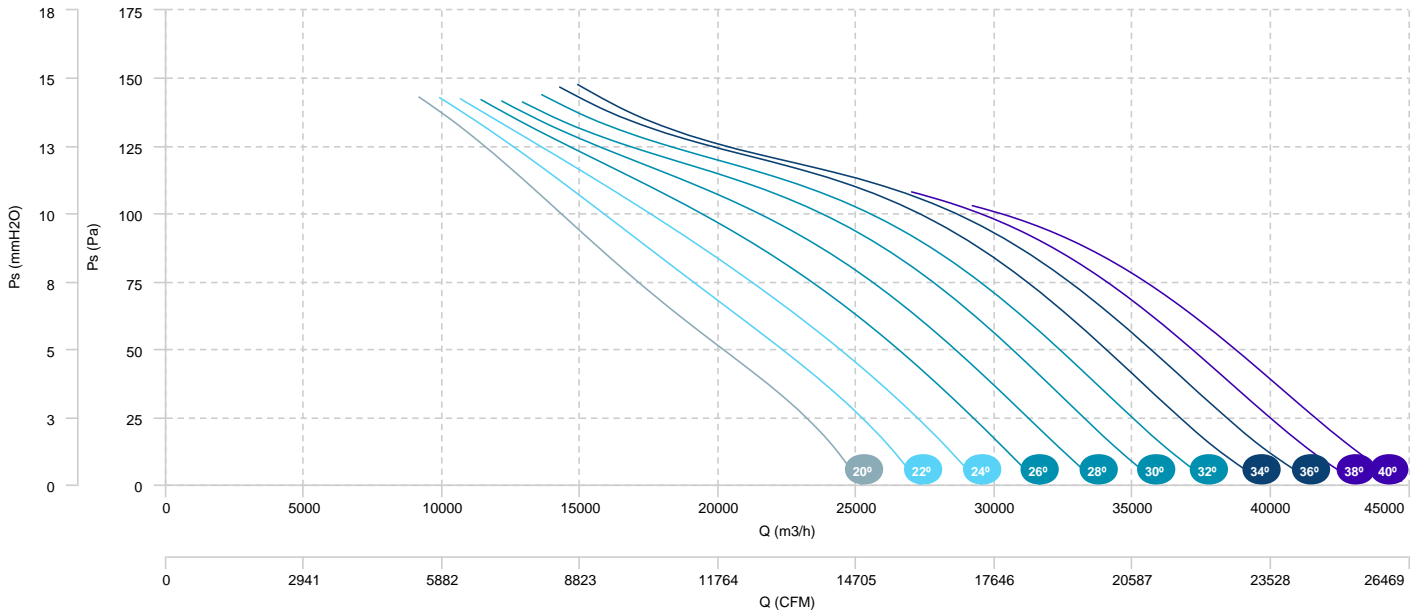

BOX HBF 125 T4 18,5kW (A3:8) F400	BOX HBF 125 T4 22kW (A3:8) F400	BOX HBF 125 T4 30kW (A3:8) F400
BOX HBF 125 T4 37kW (A3:8) F400	BOX HBF 125 T4 45kW (A3:8) F400	

AIR FLOW - PRESSURE

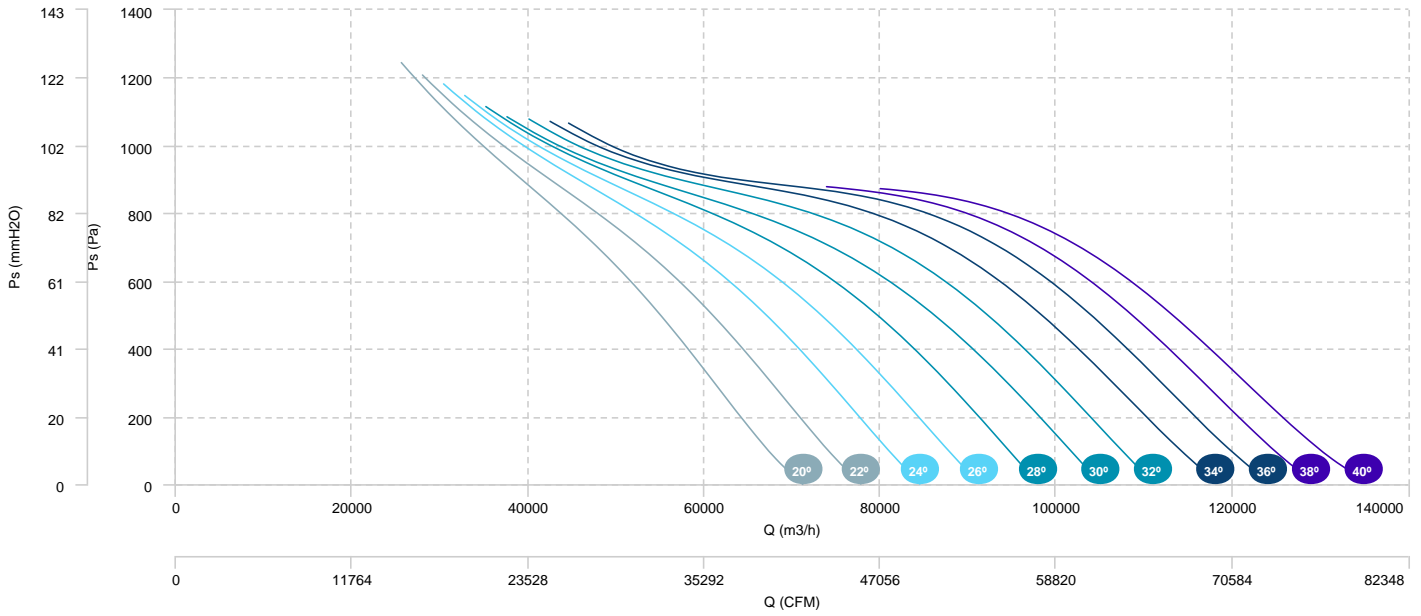

AIR FLOW - ABSORBED POWER

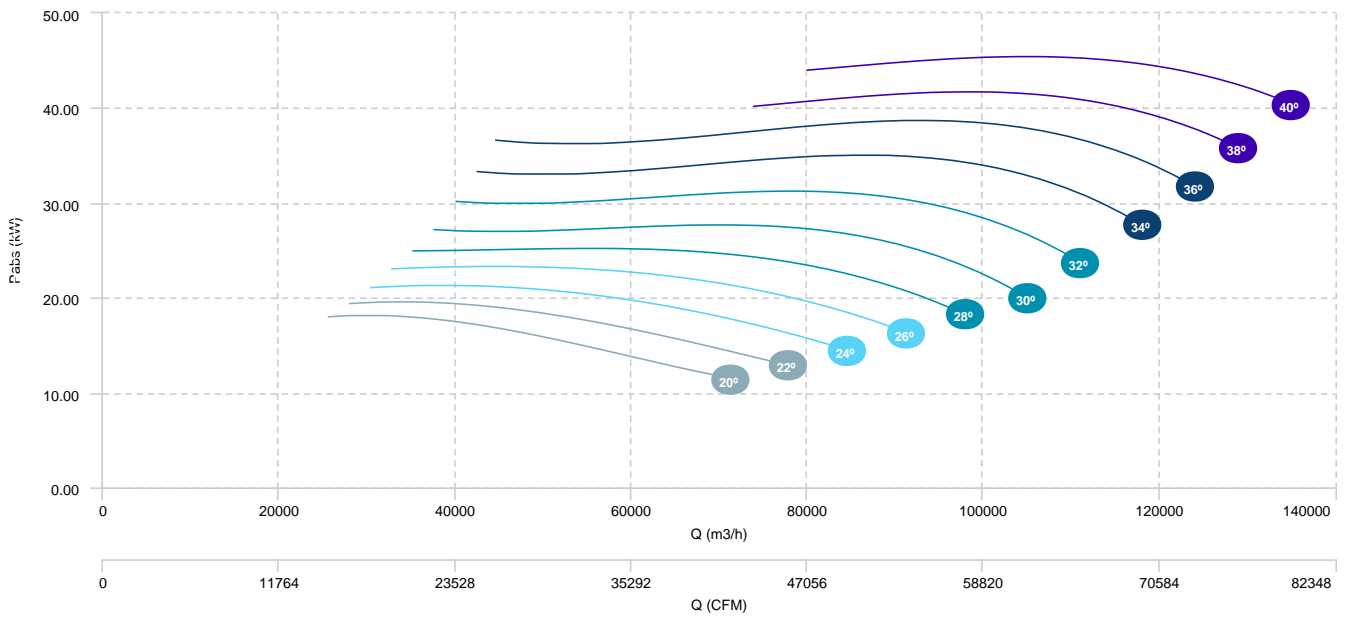

BOX HBF 125 T4 11kW (A3:4) F400	BOX HBF 125 T4 15kW (A3:4) F400	BOX HBF 125 T4 18,5kW (A3:4) F400
BOX HBF 125 T4 22kW (A3:4) F400	BOX HBF 125 T4 30kW (A3:4) F400	

AIR FLOW - PRESSURE

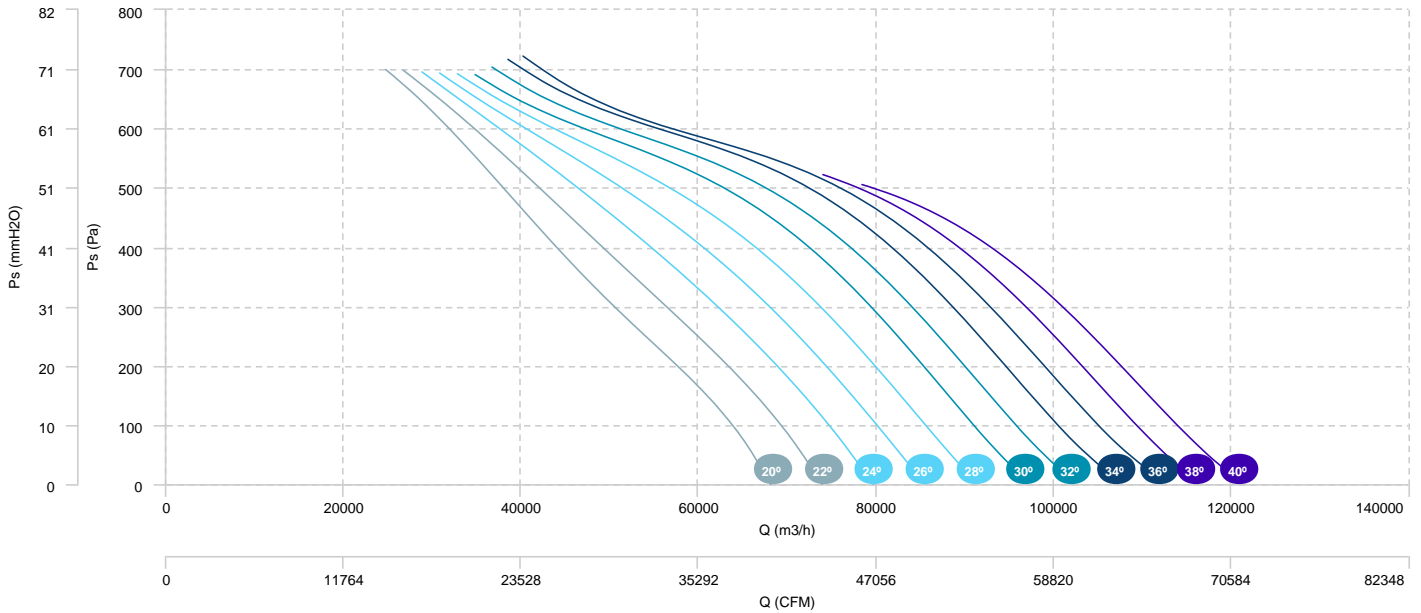

AIR FLOW - ABSORBED POWER

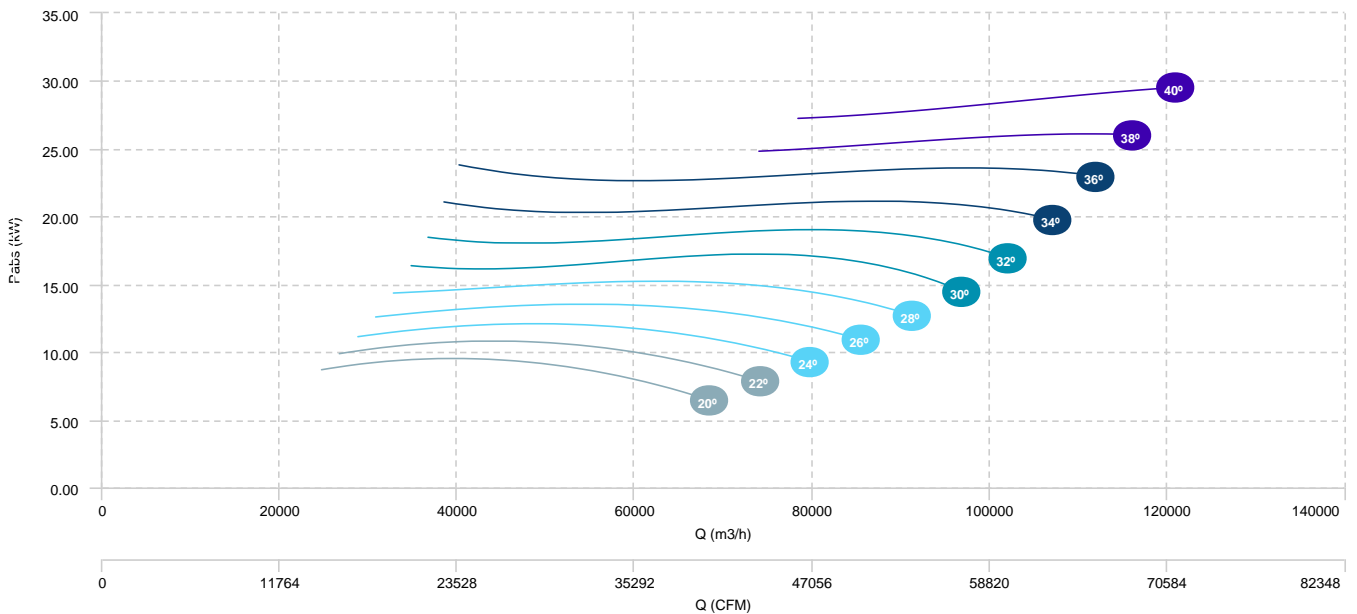

BOX HBF 125 T6 3kW (A3:4) F400

BOX HBF 125 T6 4kW (A3:4) F400

BOX HBF 125 T6 5,5kW (A3:4) F400

BOX HBF 125 T6 7,5kW (A3:4) F400

AIR FLOW - PRESSURE

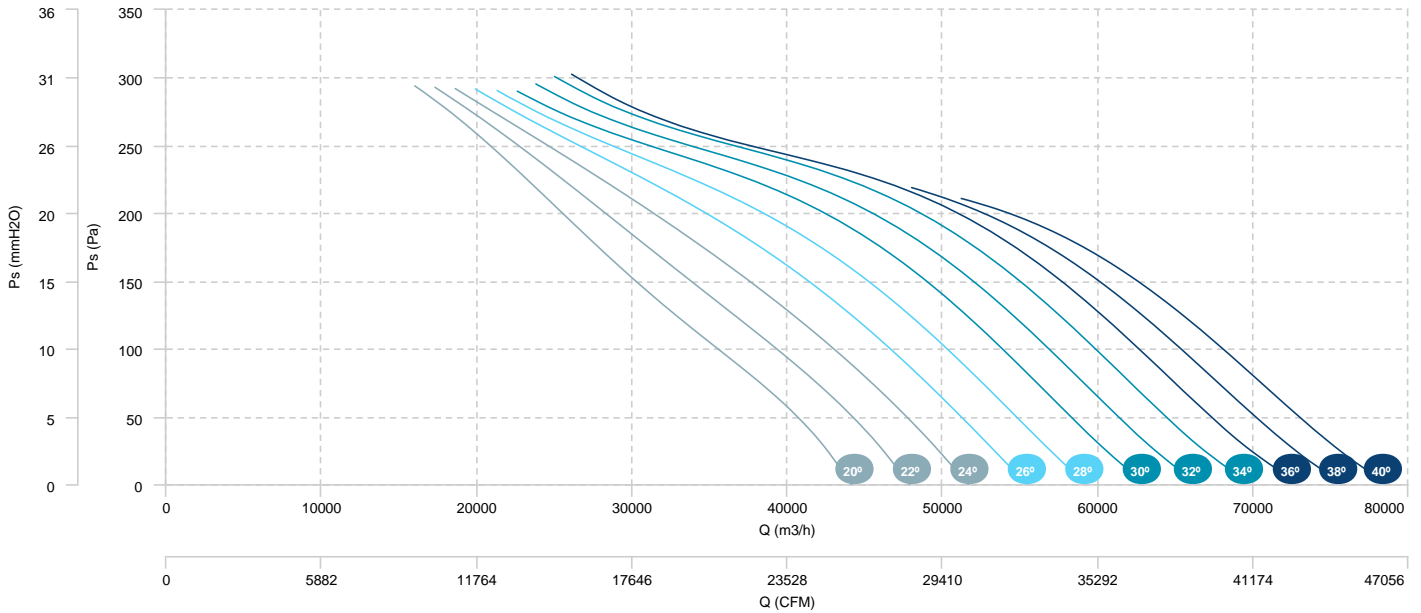

AIR FLOW - ABSORBED POWER

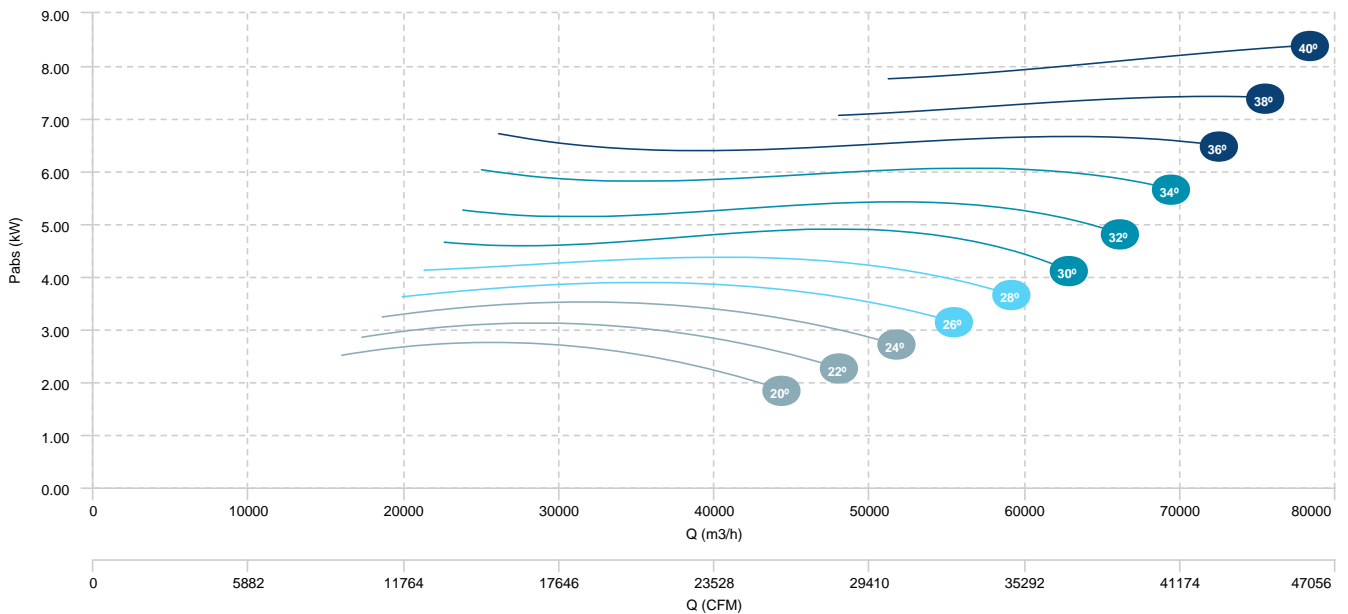

- BOX HBF 125 T6 5,5kW (A3:8) F400
  - BOX HBF 125 T6 7,5kW (A3:8) F400
  - BOX HBF 125 T6 11kW (A3:8) F400
- BOX HBF 125 T6 15kW (A3:8) F400

**AIR FLOW - PRESSURE**

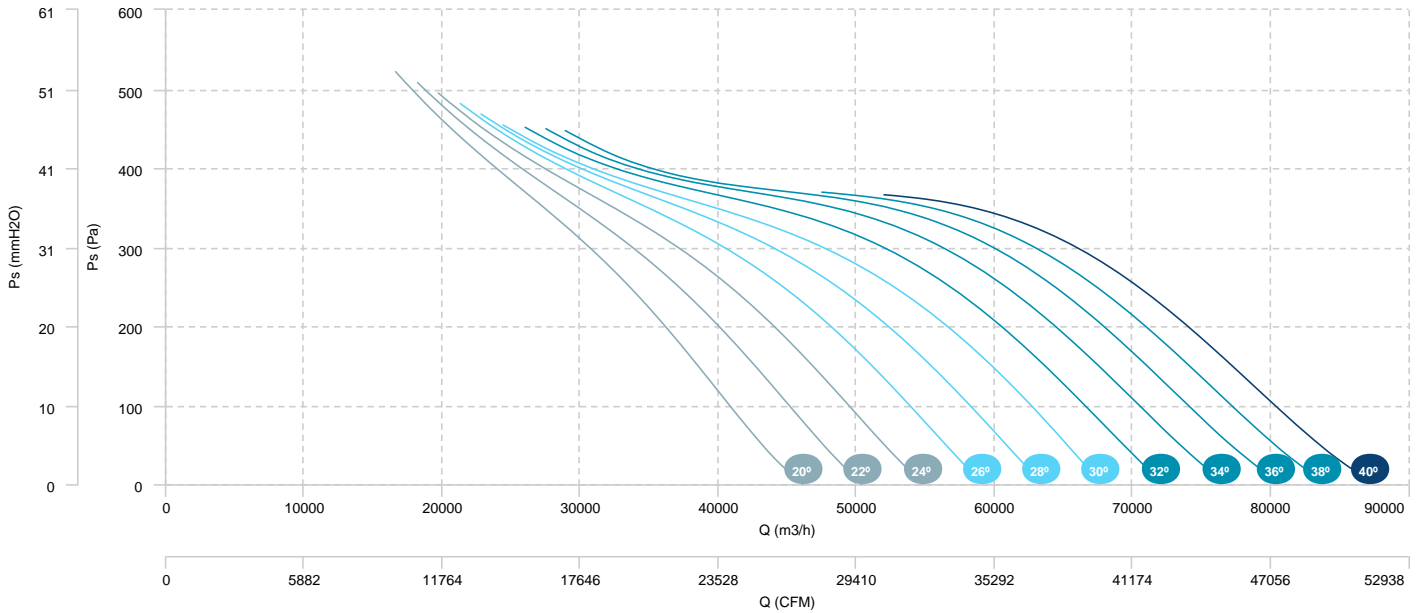

**AIR FLOW - ABSORBED POWER**

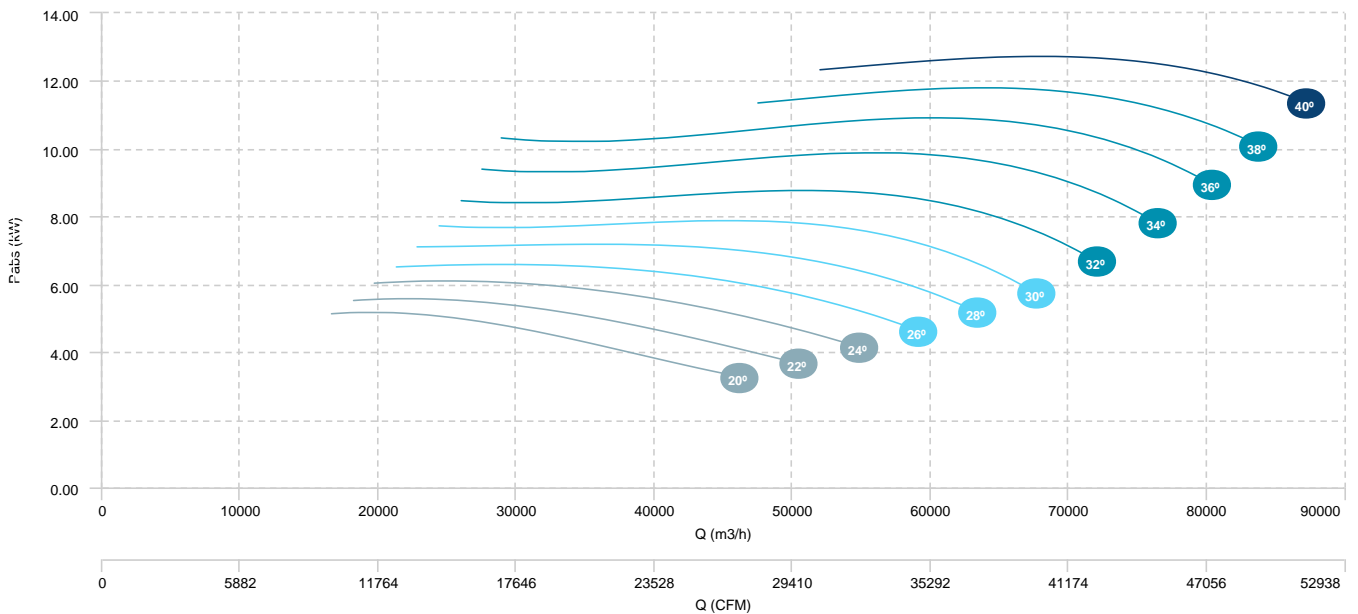

BOX HBF 125 T4/T8 20/5kW (A3:8) F400

BOX HBF 125 T4/T8 28/6,5kW (A3:8) F400

BOX HBF 125 T4/T8 37/9,2kW (A3:8) F400

BOX HBF 125 T4/T8 44/11kW (A3:8) F400

AIR FLOW - PRESSURE (4 poles)

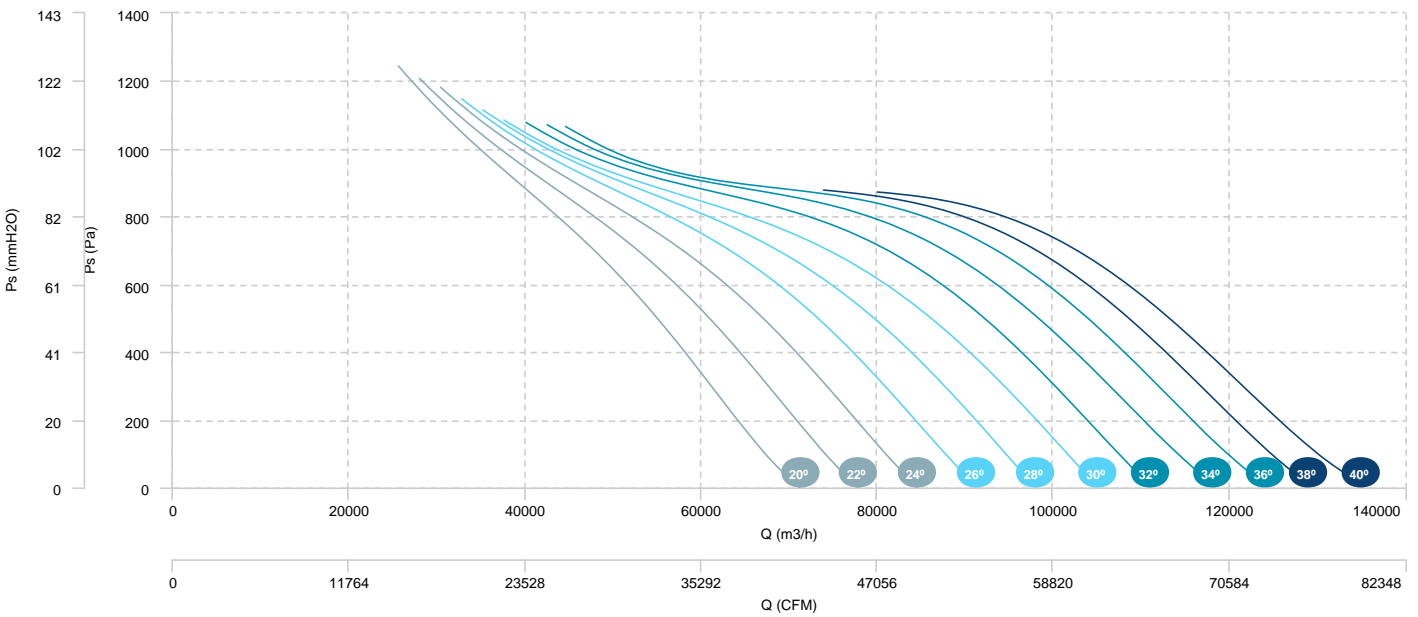

AIR FLOW - ABSORBED POWER (4 poles)

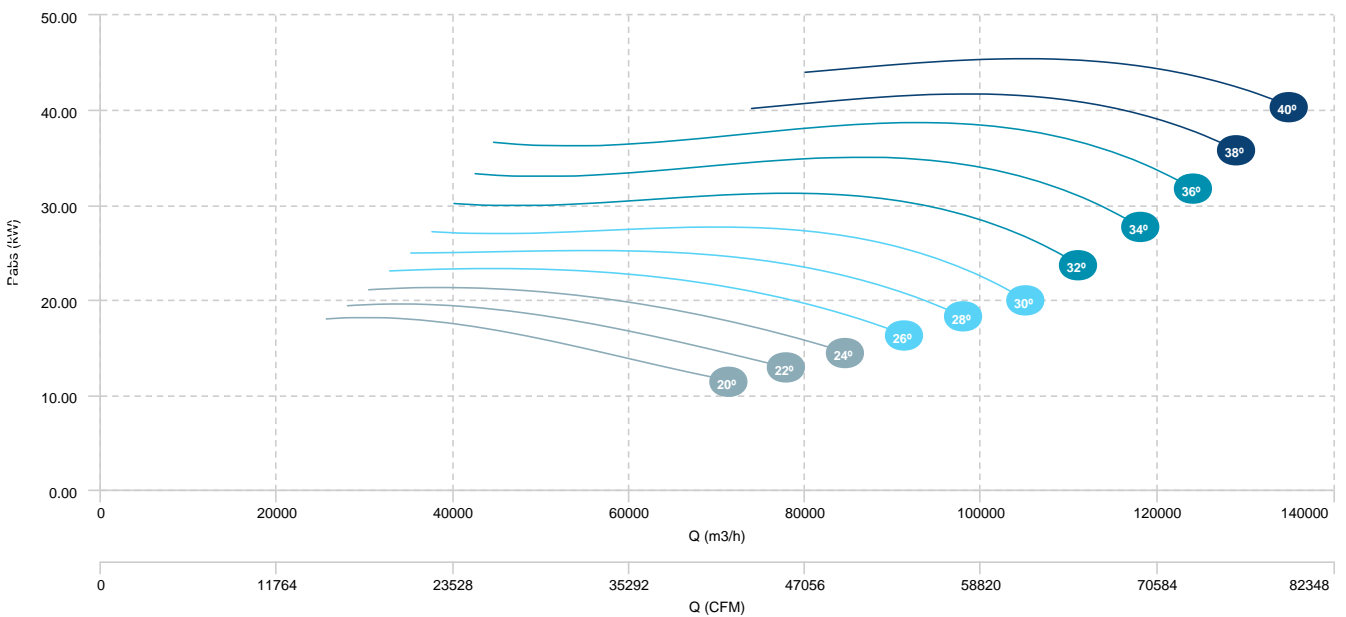



BOX HBF 125 T4/T8 20/5kW (A3:8) F400	BOX HBF 125 T4/T8 28/6,5kW (A3:8) F400	BOX HBF 125 T4/T8 37/9,2kW (A3:8) F400
BOX HBF 125 T4/T8 44/11kW (A3:8) F400		

AIR FLOW - PRESSURE (8 poles)

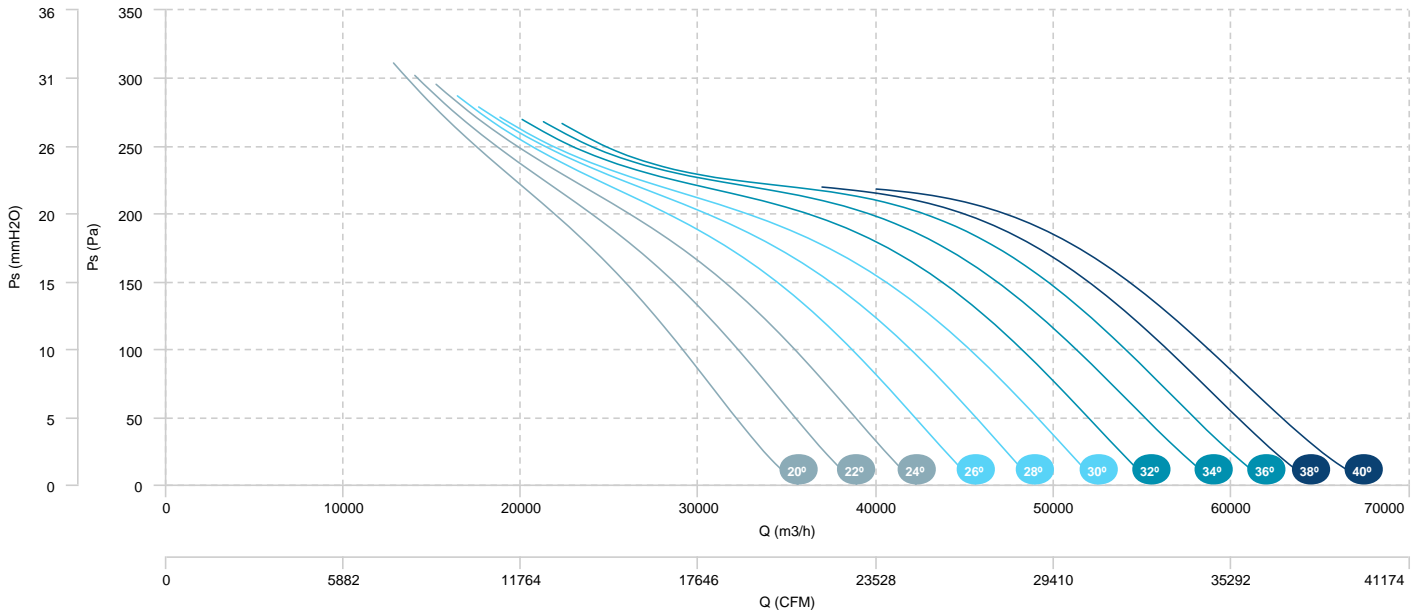

BOX HBF 125 T4/T8 11/3kW (A3:4) F400	BOX HBF 125 T4/T8 14/3,5kW (A3:4) F400	BOX HBF 125 T4/T8 17/4,3kW (A3:4) F400
BOX HBF 125 T4/T8 20/5kW (A3:4) F400	BOX HBF 125 T4/T8 28/6,5kW (A3:4) F400	

**AIR FLOW - PRESSURE (4 poles)**

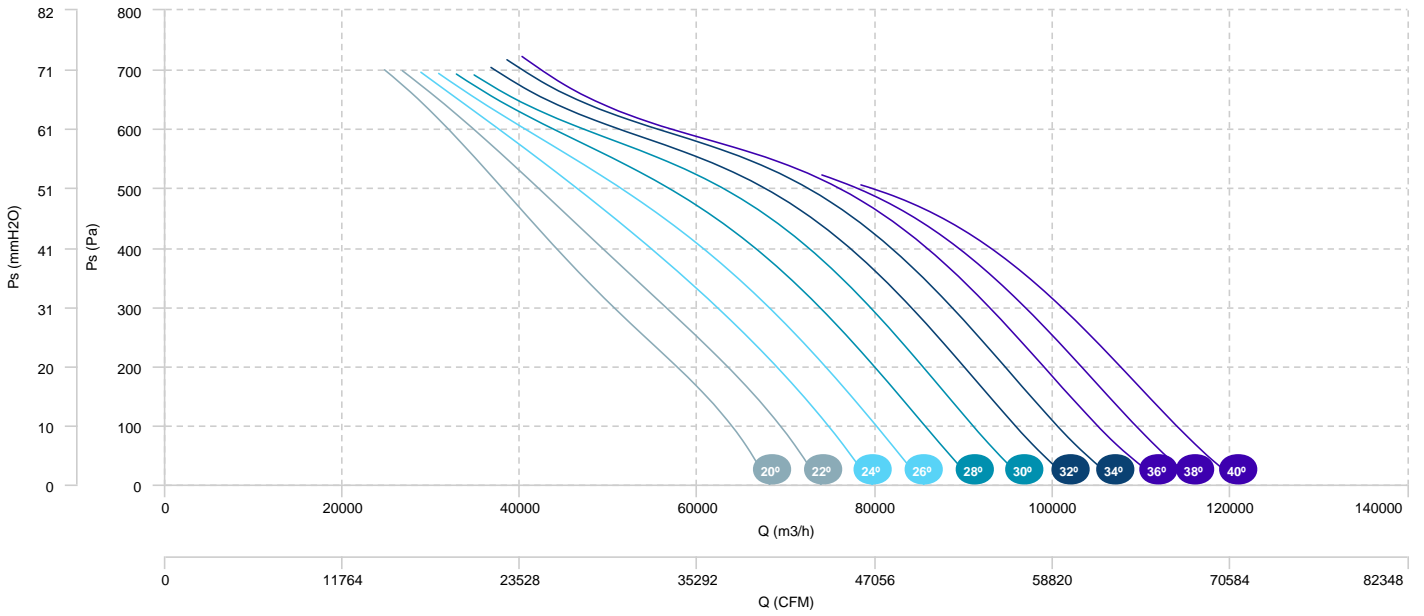

**AIR FLOW - ABSORBED POWER (4 poles)**

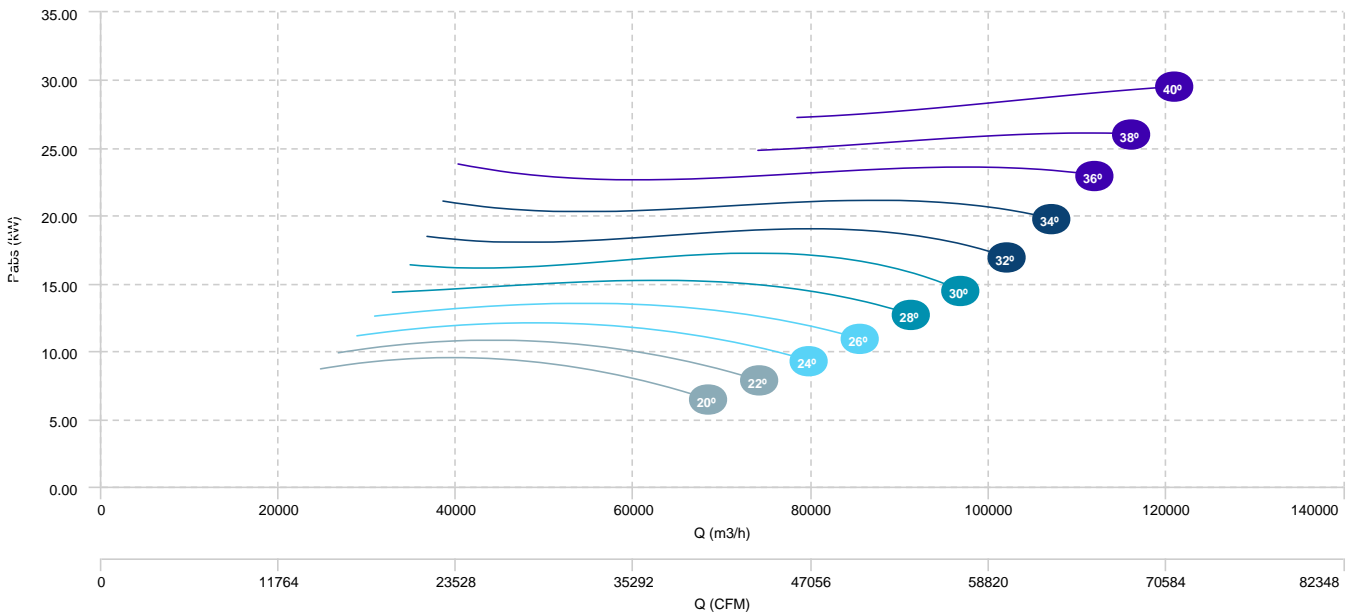

BOX HBF 125 T4/T8 11/3kW (A3:4) F400	BOX HBF 125 T4/T8 14/3,5kW (A3:4) F400	BOX HBF 125 T4/T8 17/4,3kW (A3:4) F400
BOX HBF 125 T4/T8 20/5kW (A3:4) F400	BOX HBF 125 T4/T8 28/6,5kW (A3:4) F400	

AIR FLOW - PRESSURE (8 poles)

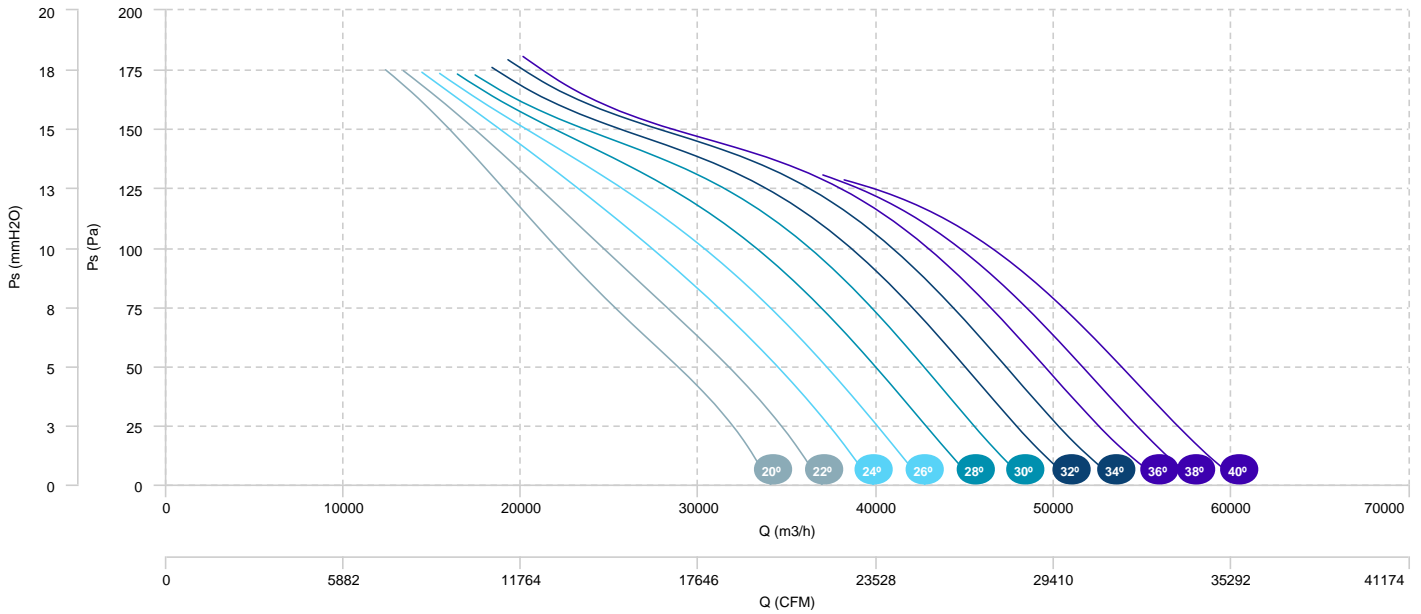

## Sound data

### Sound / 4 poles

		Sound power Lw dB (A)								
Model		63 Hz	125 Hz	250 Hz	500 Hz	1000 Hz	2000 Hz	4000 Hz	8000 Hz	Total
BOX HBF 45 T4 0,75kW (A5:6) F400 (40°)	Inlet	47	54	59	64	67	67	68	61	73
BOX HBF 50 T4 0,75kW (A5:6) F400 (40°)	Inlet	50	57	62	66	69	68	69	63	75
BOX HBF 56 T4 0,75kW (A5:6) F400 (25°)	Inlet	51	59	64	72	76	73	75	67	81
BOX HBF 56 T4 0,75kW (A5:6) F400 (32.5°)	Inlet	51	58	63	72	72	73	76	67	80
BOX HBF 56 T4 0,75kW (A5:6) F400 (30°)	Inlet	53	60	65	74	75	75	77	69	82
BOX HBF 56 T4 1,1kW (A5:6) F400 (37.5°)	Inlet	51	58	63	72	71	73	75	66	79
BOX HBF 56 T4 1,1kW (A5:6) F400 (35°)	Inlet	50	57	62	71	70	72	75	66	79
BOX HBF 56 T4 1,5kW (A5:6) F400 (40°)	Inlet	53	60	65	73	72	73	76	67	80
BOX HBF 56 T4 1,5kW (A5:6) F400 (42.5°)	Inlet	55	62	67	73	73	74	76	67	81
BOX HBF 63 T4 0,75kW (A5:6) F400 (25°)	Inlet	54	63	68	77	77	76	77	72	83
BOX HBF 63 T4 1,1kW (A5:6) F400 (30°)	Inlet	57	65	71	77	77	76	79	74	84
BOX HBF 63 T4 1,5kW (A5:6) F400 (35°)	Inlet	56	64	69	72	73	73	76	70	80
BOX HBF 63 T4 1,5kW (A5:6) F400 (32.5°)	Inlet	56	65	70	74	75	74	77	72	82
BOX HBF 63 T4 2,2kW (A5:6) F400 (37.5°)	Inlet	56	64	69	73	74	74	76	70	81
BOX HBF 63 T4 2,2kW (A5:6) F400 (40°)	Inlet	57	64	69	74	75	75	77	70	82
BOX HBF 71 T4 0,75kW (A5:6) F400 (20°)	Inlet	52	63	68	83	82	79	81	73	88
BOX HBF 71 T4 1,1kW (A5:6) F400 (25°)	Inlet	56	64	69	81	81	79	81	72	87
BOX HBF 71 T4 1,5kW (A5:6) F400 (30°)	Inlet	58	65	70	79	79	80	81	70	86
BOX HBF 71 T4 2,2kW (A5:6) F400 (35°)	Inlet	59	66	71	73	77	79	80	69	84
BOX HBF 71 T4 2,2kW (A5:6) F400 (32.5°)	Inlet	59	66	71	76	78	80	81	70	85
BOX HBF 71 T4 3kW (A5:6) F400 (40°)	Inlet	64	70	76	78	81	82	83	73	88

		Sound power Lw dB (A)								
Model		63 Hz	125 Hz	250 Hz	500 Hz	1000 Hz	2000 Hz	4000 Hz	8000 Hz	Total
BOX HBF 71 T4 3kW (A5:6) F400 (37.5°)	Inlet	62	68	74	76	79	81	82	71	86
BOX HBF 80 T4 3kW (A5:6) F400 (35°)	Inlet	59	66	71	76	79	79	83	73	86
BOX HBF 80 T4 3kW (A5:6) F400 (32.5°)	Inlet	60	67	72	78	82	81	85	77	88
BOX HBF 80 T4 3kW (A5:6) F400 (30°)	Inlet	61	68	73	80	84	83	87	80	91
BOX HBF 80 T4 4kW (A5:6) F400 (37.5°)	Inlet	61	68	73	77	80	80	83	73	87
BOX HBF 80 T4 4kW (A5:6) F400 (40°)	Inlet	63	70	75	79	81	81	83	73	88
BOX HBF 90 T4 3kW (A3:4) F400 (22°)	Inlet	58	66	71	80	84	84	83	74	89
BOX HBF 90 T4 3kW (A3:4) F400 (20°)	Inlet	54	65	70	81	85	85	83	75	90
BOX HBF 90 T4 4kW (A3:4) F400 (26°)	Inlet	61	68	73	80	82	82	81	73	88
BOX HBF 90 T4 4kW (A3:4) F400 (24°)	Inlet	60	67	72	80	83	83	82	74	88
BOX HBF 90 T4 5,5kW (A3:4) F400 (32°)	Inlet	63	70	75	79	80	80	80	72	86
BOX HBF 90 T4 5,5kW (A3:4) F400 (30°)	Inlet	63	70	75	80	80	80	80	72	86
BOX HBF 90 T4 5,5kW (A3:4) F400 (28°)	Inlet	62	69	74	80	81	81	81	73	87
BOX HBF 90 T4 5,5kW (A3:8) F400 (24°)	Inlet	66	76	83	86	88	85	85	75	93
BOX HBF 90 T4 5,5kW (A3:8) F400 (22°)	Inlet	66	77	85	87	89	84	85	75	94
BOX HBF 90 T4 5,5kW (A3:8) F400 (20°)	Inlet	66	78	87	88	90	84	85	75	95
BOX HBF 90 T4 7,5kW (A3:4) F400 (38°)	Inlet	64	71	76	79	82	81	80	73	88
BOX HBF 90 T4 7,5kW (A3:4) F400 (36°)	Inlet	63	70	75	78	81	81	79	71	87
BOX HBF 90 T4 7,5kW (A3:4) F400 (34°)	Inlet	62	69	74	78	80	81	79	71	86
BOX HBF 90 T4 7,5kW (A3:8) F400 (28°)	Inlet	67	73	79	84	86	85	84	76	91
BOX HBF 90 T4 7,5kW (A3:8) F400 (26°)	Inlet	67	75	81	85	87	85	85	76	92
BOX HBF 90 T4 11kW (A3:4) F400 (40°)	Inlet	65	72	77	80	84	82	81	74	88
BOX HBF 90 T4 11kW (A3:8) F400 (36°)	Inlet	64	71	76	80	84	84	82	74	89

Sound power Lw dB (A)										
Model		63 Hz	125 Hz	250 Hz	500 Hz	1000 Hz	2000 Hz	4000 Hz	8000 Hz	Total
BOX HBF 90 T4 11kW (A3:8) F400 (34°)	Inlet	64	71	76	81	84	84	82	74	89
BOX HBF 90 T4 11kW (A3:8) F400 (32°)	Inlet	64	71	76	82	84	84	83	75	90
BOX HBF 90 T4 11kW (A3:8) F400 (30°)	Inlet	65	72	77	83	85	85	84	76	91
BOX HBF 90 T4 15kW (A3:8) F400 (40°)	Inlet	68	75	80	81	85	84	81	75	90
BOX HBF 90 T4 15kW (A3:8) F400 (38°)	Inlet	66	73	78	81	84	84	81	74	89
BOX HBF 100 T4 5,5kW (A3:4) F400 (26°)	Inlet	64	72	78	84	87	88	90	85	94
BOX HBF 100 T4 5,5kW (A3:4) F400 (24°)	Inlet	64	73	78	84	88	89	90	86	95
BOX HBF 100 T4 5,5kW (A3:4) F400 (22°)	Inlet	63	73	79	85	88	89	90	87	95
BOX HBF 100 T4 5,5kW (A3:4) F400 (20°)	Inlet	63	73	78	85	88	89	90	87	95
BOX HBF 100 T4 7,5kW (A3:4) F400 (30°)	Inlet	65	71	78	83	87	88	90	83	94
BOX HBF 100 T4 7,5kW (A3:4) F400 (28°)	Inlet	64	72	78	83	87	88	90	84	94
BOX HBF 100 T4 7,5kW (A3:8) F400 (20°)	Inlet	69	78	89	99	97	96	97	92	104
BOX HBF 100 T4 11kW (A3:4) F400 (38°)	Inlet	65	71	78	83	86	87	89	82	93
BOX HBF 100 T4 11kW (A3:4) F400 (36°)	Inlet	66	70	78	83	85	87	88	82	93
BOX HBF 100 T4 11kW (A3:4) F400 (34°)	Inlet	66	70	78	82	85	87	88	82	93
BOX HBF 100 T4 11kW (A3:4) F400 (32°)	Inlet	65	71	78	83	86	87	89	83	93
BOX HBF 100 T4 11kW (A3:8) F400 (28°)	Inlet	69	76	84	90	93	92	93	88	99
BOX HBF 100 T4 11kW (A3:8) F400 (26°)	Inlet	69	76	85	92	93	93	94	89	100
BOX HBF 100 T4 11kW (A3:8) F400 (24°)	Inlet	69	76	86	94	94	94	95	90	101
BOX HBF 100 T4 11kW (A3:8) F400 (22°)	Inlet	69	77	88	97	96	95	96	91	103
BOX HBF 100 T4 15kW (A3:4) F400 (40°)	Inlet	65	72	78	84	87	88	89	83	94
BOX HBF 100 T4 15kW (A3:8) F400 (34°)	Inlet	68	75	80	85	89	90	91	85	96
BOX HBF 100 T4 15kW (A3:8) F400 (32°)	Inlet	68	76	81	87	90	91	92	86	97

Sound power Lw dB (A)										
Model		63 Hz	125 Hz	250 Hz	500 Hz	1000 Hz	2000 Hz	4000 Hz	8000 Hz	Total
BOX HBF 100 T4 15kW (A3:8) F400 (30°)	Inlet	69	76	83	88	92	92	93	87	98
BOX HBF 100 T4 18,5kW (A3:8) F400 (38°)	Inlet	68	75	80	85	89	91	91	85	96
BOX HBF 100 T4 18,5kW (A3:8) F400 (36°)	Inlet	67	74	79	84	88	90	91	84	96
BOX HBF 100 T4 22kW (A3:8) F400 (40°)	Inlet	68	76	81	86	89	91	92	86	97
BOX HBF 112 T4 5,5kW (A3:4) F400 (20°)	Inlet	63	75	80	87	91	91	93	89	98
BOX HBF 112 T4 7,5kW (A3:4) F400 (24°)	Inlet	66	75	80	87	90	91	93	88	98
BOX HBF 112 T4 7,5kW (A3:4) F400 (22°)	Inlet	65	76	81	87	91	92	93	89	99
BOX HBF 112 T4 11kW (A3:4) F400 (32°)	Inlet	67	74	79	84	88	89	91	84	95
BOX HBF 112 T4 11kW (A3:4) F400 (30°)	Inlet	68	75	80	85	89	90	91	85	96
BOX HBF 112 T4 11kW (A3:4) F400 (28°)	Inlet	68	75	80	86	89	90	92	86	96
BOX HBF 112 T4 11kW (A3:4) F400 (26°)	Inlet	67	75	80	86	90	91	92	87	97
BOX HBF 112 T4 11kW (A3:8) F400 (22°)	Inlet	70	78	88	96	97	99	99	93	104
BOX HBF 112 T4 11kW (A3:8) F400 (20°)	Inlet	70	79	89	98	98	100	100	94	106
BOX HBF 112 T4 15kW (A3:4) F400 (38°)	Inlet	68	74	80	85	88	89	90	84	95
BOX HBF 112 T4 15kW (A3:4) F400 (36°)	Inlet	68	73	80	84	87	89	90	83	95
BOX HBF 112 T4 15kW (A3:4) F400 (34°)	Inlet	67	73	79	84	87	89	90	83	95
BOX HBF 112 T4 15kW (A3:8) F400 (28°)	Inlet	71	78	85	91	95	96	96	91	102
BOX HBF 112 T4 15kW (A3:8) F400 (26°)	Inlet	71	78	86	93	95	97	97	91	103
BOX HBF 112 T4 15kW (A3:8) F400 (24°)	Inlet	70	78	87	94	96	98	98	92	103
BOX HBF 112 T4 18,5kW (A3:4) F400 (40°)	Inlet	69	76	81	86	88	90	91	84	96
BOX HBF 112 T4 18,5kW (A3:8) F400 (32°)	Inlet	71	78	83	88	93	94	94	88	100
BOX HBF 112 T4 18,5kW (A3:8) F400 (30°)	Inlet	71	77	84	90	94	96	96	90	101
BOX HBF 112 T4 22kW (A3:8) F400 (36°)	Inlet	70	77	82	87	90	92	92	86	98

Sound power Lw dB (A)										
Model		63 Hz	125 Hz	250 Hz	500 Hz	1000 Hz	2000 Hz	4000 Hz	8000 Hz	Total
BOX HBF 112 T4 22kW (A3:8) F400 (34°)	Inlet	70	77	82	87	91	93	93	86	98
BOX HBF 112 T4 30kW (A3:8) F400 (40°)	Inlet	71	78	83	87	91	93	92	87	98
BOX HBF 112 T4 30kW (A3:8) F400 (38°)	Inlet	70	77	82	87	91	93	92	86	98
BOX HBF 125 T4 11kW (A3:4) F400 (22°)	Inlet	72	83	88	95	99	100	102	98	106
BOX HBF 125 T4 11kW (A3:4) F400 (20°)	Inlet	69	82	87	95	99	99	101	98	106
BOX HBF 125 T4 15kW (A3:4) F400 (28°)	Inlet	72	79	84	90	93	95	96	90	101
BOX HBF 125 T4 15kW (A3:4) F400 (26°)	Inlet	73	81	86	91	95	96	98	92	103
BOX HBF 125 T4 15kW (A3:4) F400 (24°)	Inlet	72	82	87	93	97	98	100	95	104
BOX HBF 125 T4 18,5kW (A3:4) F400 (32°)	Inlet	71	78	83	87	91	93	93	87	99
BOX HBF 125 T4 18,5kW (A3:4) F400 (30°)	Inlet	71	78	83	88	92	93	94	88	99
BOX HBF 125 T4 18,5kW (A3:8) F400 (22°)	Inlet	76	83	90	99	104	107	106	101	111
BOX HBF 125 T4 18,5kW (A3:8) F400 (20°)	Inlet	75	83	90	100	105	108	107	102	112
BOX HBF 125 T4 22kW (A3:4) F400 (36°)	Inlet	71	78	83	87	90	92	93	85	98
BOX HBF 125 T4 22kW (A3:4) F400 (34°)	Inlet	70	77	82	87	90	92	93	85	98
BOX HBF 125 T4 22kW (A3:8) F400 (26°)	Inlet	75	82	88	95	101	103	103	97	108
BOX HBF 125 T4 22kW (A3:8) F400 (24°)	Inlet	75	82	89	97	103	105	105	99	110
BOX HBF 125 T4 30kW (A3:4) F400 (40°)	Inlet	72	79	84	88	90	93	93	86	99
BOX HBF 125 T4 30kW (A3:4) F400 (38°)	Inlet	71	78	83	88	90	92	93	86	98
BOX HBF 125 T4 30kW (A3:8) F400 (32°)	Inlet	74	80	86	92	96	99	99	91	104
BOX HBF 125 T4 30kW (A3:8) F400 (30°)	Inlet	74	80	87	93	98	100	101	94	105
BOX HBF 125 T4 30kW (A3:8) F400 (28°)	Inlet	75	81	88	94	99	102	102	95	107
BOX HBF 125 T4 37kW (A3:8) F400 (36°)	Inlet	74	80	86	90	93	95	95	88	101
BOX HBF 125 T4 37kW (A3:8) F400 (34°)	Inlet	74	80	86	91	94	96	97	89	102



Sound power Lw dB (A)										
Model		63 Hz	125 Hz	250 Hz	500 Hz	1000 Hz	2000 Hz	4000 Hz	8000 Hz	Total
BOX HBF 125 T4 45kW (A3:8) F400 (40°)	Inlet	73	80	85	90	93	95	94	87	100
BOX HBF 125 T4 45kW (A3:8) F400 (38°)	Inlet	73	80	85	90	93	95	94	88	101

## Sound / 6 poles

Sound power Lw dB (A)										
Model		63 Hz	125 Hz	250 Hz	500 Hz	1000 Hz	2000 Hz	4000 Hz	8000 Hz	Total
BOX HBF 50 T6 0,75kW (A5:6) F400 (40°)	Inlet	41	48	53	57	60	59	61	54	66
BOX HBF 56 T6 0,75kW (A5:6) F400 (40°)	Inlet	44	51	56	64	63	64	67	58	71
BOX HBF 63 T6 0,75kW (A5:6) F400 (40°)	Inlet	48	55	60	65	66	66	68	61	73
BOX HBF 71 T6 0,75kW (A5:6) F400 (40°)	Inlet	56	62	68	70	73	74	75	65	80
BOX HBF 71 T6 0,75kW (A5:6) F400 (37.5°)	Inlet	53	60	65	67	70	72	73	62	78
BOX HBF 71 T6 0,75kW (A5:6) F400 (35°)	Inlet	51	58	63	64	68	70	71	60	76
BOX HBF 80 T6 0,75kW (A5:6) F400 (30°)	Inlet	52	59	64	71	75	74	78	71	82
BOX HBF 80 T6 1,1kW (A5:6) F400 (32.5°)	Inlet	51	58	63	69	73	72	76	68	80
BOX HBF 80 T6 1,1kW (A5:6) F400 (35°)	Inlet	50	57	62	67	70	71	74	64	78
BOX HBF 80 T6 1,5kW (A5:6) F400 (37.5°)	Inlet	52	59	64	68	71	72	74	65	78
BOX HBF 80 T6 1,5kW (A5:6) F400 (40°)	Inlet	54	61	66	70	72	73	74	65	79
BOX HBF 80 T6 2,2kW (A5:6) F400 (42.5°)	Inlet	55	62	67	71	73	73	74	65	79
BOX HBF 90 T6 1,5kW (A3:4) F400 (20°)	Inlet	44	55	60	71	75	75	74	66	80
BOX HBF 90 T6 1,5kW (A3:4) F400 (26°)	Inlet	52	59	64	71	72	72	72	64	78
BOX HBF 90 T6 1,5kW (A3:4) F400 (24°)	Inlet	51	58	63	71	73	73	73	64	79
BOX HBF 90 T6 1,5kW (A3:4) F400 (22°)	Inlet	48	57	62	71	74	74	73	65	80
BOX HBF 90 T6 1,5kW (A3:4) F400 (32°)	Inlet	54	61	66	70	71	71	70	62	77
BOX HBF 90 T6 1,5kW (A3:4) F400 (30°)	Inlet	54	61	66	70	70	70	71	63	77



		Sound power Lw dB (A)								
Model		63 Hz	125 Hz	250 Hz	500 Hz	1000 Hz	2000 Hz	4000 Hz	8000 Hz	Total
BOX HBF 90 T6 1,5kW (A3:4) F400 (28°)	Inlet	53	60	65	70	71	71	71	63	78
BOX HBF 90 T6 1,5kW (A3:8) F400 (24°)	Inlet	57	66	74	77	79	75	75	66	83
BOX HBF 90 T6 1,5kW (A3:8) F400 (22°)	Inlet	57	68	76	78	80	75	75	66	84
BOX HBF 90 T6 1,5kW (A3:8) F400 (20°)	Inlet	57	69	78	79	81	75	76	66	85
BOX HBF 90 T6 2,2kW (A3:4) F400 (40°)	Inlet	56	63	68	70	74	72	71	64	79
BOX HBF 90 T6 2,2kW (A3:4) F400 (38°)	Inlet	55	62	67	70	73	72	71	63	78
BOX HBF 90 T6 2,2kW (A3:4) F400 (36°)	Inlet	53	60	65	69	72	72	70	62	77
BOX HBF 90 T6 2,2kW (A3:4) F400 (34°)	Inlet	53	60	65	69	71	71	70	62	77
BOX HBF 90 T6 2,2kW (A3:8) F400 (30°)	Inlet	56	63	68	74	76	76	75	67	81
BOX HBF 90 T6 2,2kW (A3:8) F400 (28°)	Inlet	57	64	70	75	77	75	75	67	82
BOX HBF 90 T6 2,2kW (A3:8) F400 (26°)	Inlet	57	65	72	76	78	75	75	66	83
BOX HBF 90 T6 3kW (A3:8) F400 (36°)	Inlet	55	62	67	71	74	74	72	65	80
BOX HBF 90 T6 3kW (A3:8) F400 (34°)	Inlet	54	61	66	71	74	75	73	65	80
BOX HBF 90 T6 3kW (A3:8) F400 (32°)	Inlet	55	62	67	73	75	75	74	66	81
BOX HBF 90 T6 4kW (A3:8) F400 (40°)	Inlet	58	65	70	72	76	75	72	65	81
BOX HBF 90 T6 4kW (A3:8) F400 (38°)	Inlet	56	63	68	71	75	75	72	65	80
BOX HBF 100 T6 1,5kW (A3:4) F400 (26°)	Inlet	54	63	68	74	78	79	80	75	85
BOX HBF 100 T6 1,5kW (A3:4) F400 (24°)	Inlet	54	63	69	75	79	79	81	76	86
BOX HBF 100 T6 1,5kW (A3:4) F400 (22°)	Inlet	54	64	69	75	79	80	81	77	86
BOX HBF 100 T6 1,5kW (A3:4) F400 (20°)	Inlet	53	64	69	75	79	80	81	78	86
BOX HBF 100 T6 2,2kW (A3:4) F400 (26°)	Inlet	54	63	68	74	78	79	80	75	85
BOX HBF 100 T6 2,2kW (A3:4) F400 (24°)	Inlet	54	63	69	75	79	79	81	76	86
BOX HBF 100 T6 2,2kW (A3:4) F400 (22°)	Inlet	54	64	69	75	79	80	81	77	86

Sound power Lw dB (A)										
Model		63 Hz	125 Hz	250 Hz	500 Hz	1000 Hz	2000 Hz	4000 Hz	8000 Hz	Total
BOX HBF 100 T6 2,2kW (A3:4) F400 (20°)	Inlet	53	64	69	75	79	80	81	78	86
BOX HBF 100 T6 2,2kW (A3:4) F400 (32°)	Inlet	56	61	68	73	76	78	80	73	84
BOX HBF 100 T6 2,2kW (A3:4) F400 (30°)	Inlet	55	62	68	74	77	78	80	74	84
BOX HBF 100 T6 2,2kW (A3:4) F400 (28°)	Inlet	55	62	68	74	78	78	80	75	85
BOX HBF 100 T6 2,2kW (A3:8) F400 (22°)	Inlet	60	68	79	87	86	85	86	82	93
BOX HBF 100 T6 2,2kW (A3:8) F400 (20°)	Inlet	60	68	80	89	88	86	87	83	94
BOX HBF 100 T6 3kW (A3:4) F400 (38°)	Inlet	56	62	69	74	77	78	79	73	84
BOX HBF 100 T6 3kW (A3:4) F400 (36°)	Inlet	56	61	68	73	76	77	79	73	83
BOX HBF 100 T6 3kW (A3:4) F400 (34°)	Inlet	56	60	68	73	76	77	79	73	83
BOX HBF 100 T6 3kW (A3:8) F400 (28°)	Inlet	59	67	75	81	83	83	84	78	89
BOX HBF 100 T6 3kW (A3:8) F400 (26°)	Inlet	59	67	76	83	84	84	84	79	90
BOX HBF 100 T6 3kW (A3:8) F400 (24°)	Inlet	59	67	77	85	85	84	85	80	91
BOX HBF 100 T6 4kW (A3:4) F400 (40°)	Inlet	56	63	69	74	78	78	80	73	84
BOX HBF 100 T6 4kW (A3:8) F400 (34°)	Inlet	58	65	70	75	79	81	82	75	86
BOX HBF 100 T6 4kW (A3:8) F400 (32°)	Inlet	59	66	72	77	81	82	82	76	87
BOX HBF 100 T6 4kW (A3:8) F400 (30°)	Inlet	59	66	74	79	82	83	83	77	89
BOX HBF 100 T6 5,5kW (A3:8) F400 (40°)	Inlet	59	66	71	76	80	82	82	76	87
BOX HBF 100 T6 5,5kW (A3:8) F400 (38°)	Inlet	58	65	70	76	79	81	82	76	87
BOX HBF 100 T6 5,5kW (A3:8) F400 (36°)	Inlet	58	65	70	75	79	81	81	75	86
BOX HBF 112 T6 2,2kW (A3:4) F400 (26°)	Inlet	57	66	71	77	80	81	83	77	87
BOX HBF 112 T6 2,2kW (A3:4) F400 (24°)	Inlet	56	66	71	77	81	82	83	78	88
BOX HBF 112 T6 2,2kW (A3:4) F400 (22°)	Inlet	55	66	71	78	82	82	84	79	89
BOX HBF 112 T6 2,2kW (A3:4) F400 (20°)	Inlet	53	65	70	77	81	82	84	79	88

Sound power Lw dB (A)										
Model		63 Hz	125 Hz	250 Hz	500 Hz	1000 Hz	2000 Hz	4000 Hz	8000 Hz	Total
BOX HBF 112 T6 3kW (A3:4) F400 (32°)	Inlet	58	64	70	75	78	80	81	75	86
BOX HBF 112 T6 3kW (A3:4) F400 (30°)	Inlet	58	65	70	76	79	80	82	75	86
BOX HBF 112 T6 3kW (A3:4) F400 (28°)	Inlet	58	65	70	76	80	81	82	76	87
BOX HBF 112 T6 3kW (A3:8) F400 (22°)	Inlet	61	69	78	86	87	89	89	84	95
BOX HBF 112 T6 3kW (A3:8) F400 (20°)	Inlet	61	69	79	88	88	90	90	85	96
BOX HBF 112 T6 4kW (A3:4) F400 (38°)	Inlet	59	65	71	75	78	80	81	74	86
BOX HBF 112 T6 4kW (A3:4) F400 (36°)	Inlet	58	64	70	75	78	79	81	74	85
BOX HBF 112 T6 4kW (A3:4) F400 (34°)	Inlet	58	63	70	75	78	79	81	74	85
BOX HBF 112 T6 4kW (A3:8) F400 (28°)	Inlet	61	68	76	82	86	87	87	81	92
BOX HBF 112 T6 4kW (A3:8) F400 (26°)	Inlet	61	68	76	83	86	87	87	82	93
BOX HBF 112 T6 4kW (A3:8) F400 (24°)	Inlet	61	68	77	85	87	88	88	83	93
BOX HBF 112 T6 5,5kW (A3:4) F400 (40°)	Inlet	60	66	72	76	79	81	81	75	86
BOX HBF 112 T6 5,5kW (A3:8) F400 (34°)	Inlet	61	68	73	78	81	83	84	77	89
BOX HBF 112 T6 5,5kW (A3:8) F400 (32°)	Inlet	61	68	74	79	83	85	85	79	90
BOX HBF 112 T6 5,5kW (A3:8) F400 (30°)	Inlet	62	68	75	80	85	86	86	81	91
BOX HBF 112 T6 7,5kW (A3:8) F400 (40°)	Inlet	61	68	73	78	82	84	83	77	89
BOX HBF 112 T6 7,5kW (A3:8) F400 (38°)	Inlet	61	68	73	78	81	83	83	77	88
BOX HBF 112 T6 7,5kW (A3:8) F400 (36°)	Inlet	60	67	72	77	81	83	83	76	88
BOX HBF 125 T6 3kW (A3:4) F400 (24°)	Inlet	63	72	77	84	87	88	90	85	95
BOX HBF 125 T6 3kW (A3:4) F400 (22°)	Inlet	62	74	79	86	89	90	92	88	96
BOX HBF 125 T6 3kW (A3:4) F400 (20°)	Inlet	60	73	78	86	89	89	91	88	96
BOX HBF 125 T6 4kW (A3:4) F400 (28°)	Inlet	63	70	75	80	84	85	86	81	91
BOX HBF 125 T6 4kW (A3:4) F400 (26°)	Inlet	63	71	76	82	86	87	88	83	93

Sound power Lw dB (A)										
Model		63 Hz	125 Hz	250 Hz	500 Hz	1000 Hz	2000 Hz	4000 Hz	8000 Hz	Total
BOX HBF 125 T6 5,5kW (A3:4) F400 (34°)	Inlet	61	68	73	78	81	82	83	76	88
BOX HBF 125 T6 5,5kW (A3:4) F400 (32°)	Inlet	61	68	73	78	81	83	84	77	89
BOX HBF 125 T6 5,5kW (A3:4) F400 (30°)	Inlet	62	69	74	78	82	84	85	78	89
BOX HBF 125 T6 5,5kW (A3:8) F400 (24°)	Inlet	66	73	80	87	93	95	95	89	100
BOX HBF 125 T6 5,5kW (A3:8) F400 (22°)	Inlet	66	74	81	89	94	97	96	91	102
BOX HBF 125 T6 5,5kW (A3:8) F400 (20°)	Inlet	66	74	81	90	95	98	98	92	103
BOX HBF 125 T6 7,5kW (A3:4) F400 (40°)	Inlet	62	69	74	79	81	83	84	77	89
BOX HBF 125 T6 7,5kW (A3:4) F400 (38°)	Inlet	62	69	74	78	81	83	83	76	88
BOX HBF 125 T6 7,5kW (A3:4) F400 (36°)	Inlet	61	68	73	78	80	82	83	76	88
BOX HBF 125 T6 7,5kW (A3:8) F400 (30°)	Inlet	65	71	77	83	88	90	91	84	95
BOX HBF 125 T6 7,5kW (A3:8) F400 (28°)	Inlet	65	71	78	84	90	92	92	86	97
BOX HBF 125 T6 7,5kW (A3:8) F400 (26°)	Inlet	66	72	79	86	91	94	93	87	99
BOX HBF 125 T6 11kW (A3:8) F400 (38°)	Inlet	64	71	76	81	84	86	85	78	91
BOX HBF 125 T6 11kW (A3:8) F400 (36°)	Inlet	64	71	76	81	84	86	86	79	91
BOX HBF 125 T6 11kW (A3:8) F400 (34°)	Inlet	65	71	77	81	85	87	87	80	92
BOX HBF 125 T6 11kW (A3:8) F400 (32°)	Inlet	65	71	77	82	87	89	89	82	94
BOX HBF 125 T6 15kW (A3:8) F400 (40°)	Inlet	64	71	76	80	84	86	84	78	90

## Sound / 4/8 poles

Sound power Lw dB (A)										
Model		63 Hz	125 Hz	250 Hz	500 Hz	1000 Hz	2000 Hz	4000 Hz	8000 Hz	Total
BOX HBF 45 T4/T8 0,8/0,2kW (A5:6) F400 (750 RPM - 40°)	Inlet	32	39	44	49	52	52	53	46	58
BOX HBF 45 T4/T8 0,8/0,2kW (A5:6) F400 (1500 RPM - 40°)	Inlet	47	54	59	64	67	67	68	61	73
BOX HBF 50 T4/T8 0,8/0,2kW (A5:6) F400 (750 RPM - 40°)	Inlet	35	42	47	51	54	53	54	48	60



Sound power Lw dB (A)										
Model		63 Hz	125 Hz	250 Hz	500 Hz	1000 Hz	2000 Hz	4000 Hz	8000 Hz	Total
BOX HBF 50 T4/T8 0,8/0,2kW (A5:6) F400 (1500 RPM - 40°)	Inlet	50	57	62	66	69	68	69	63	75
BOX HBF 56 T4/T8 0,8/0,2kW (A5:6) F400 (750 RPM - 32.5°)	Inlet	36	43	48	57	57	58	61	52	65
BOX HBF 56 T4/T8 0,8/0,2kW (A5:6) F400 (750 RPM - 25°)	Inlet	36	44	49	57	61	58	60	52	66
BOX HBF 56 T4/T8 0,8/0,2kW (A5:6) F400 (750 RPM - 30°)	Inlet	38	45	50	59	60	59	62	54	66
BOX HBF 56 T4/T8 0,8/0,2kW (A5:6) F400 (1500 RPM - 25°)	Inlet	51	59	64	72	76	73	75	67	81
BOX HBF 56 T4/T8 0,8/0,2kW (A5:6) F400 (1500 RPM - 32.5°)	Inlet	51	58	63	72	72	73	76	67	80
BOX HBF 56 T4/T8 0,8/0,2kW (A5:6) F400 (1500 RPM - 30°)	Inlet	53	60	65	74	75	75	77	69	82
BOX HBF 56 T4/T8 1,2/0,3kW (A5:6) F400 (750 RPM - 37.5°)	Inlet	36	43	48	56	56	57	60	51	64
BOX HBF 56 T4/T8 1,2/0,3kW (A5:6) F400 (750 RPM - 35°)	Inlet	35	42	47	55	55	57	59	51	63
BOX HBF 56 T4/T8 1,2/0,3kW (A5:6) F400 (1500 RPM - 37.5°)	Inlet	51	58	63	72	71	73	75	66	79
BOX HBF 56 T4/T8 1,2/0,3kW (A5:6) F400 (1500 RPM - 35°)	Inlet	50	57	62	71	70	72	75	66	79
BOX HBF 56 T4/T8 1,6/0,4kW (A5:6) F400 (750 RPM - 40°)	Inlet	38	45	50	57	57	58	60	52	65
BOX HBF 56 T4/T8 1,6/0,4kW (A5:6) F400 (750 RPM - 42.5°)	Inlet	40	47	52	58	58	59	61	52	66
BOX HBF 56 T4/T8 1,6/0,4kW (A5:6) F400 (1500 RPM - 40°)	Inlet	53	60	65	73	72	73	76	67	80
BOX HBF 56 T4/T8 1,6/0,4kW (A5:6) F400 (1500 RPM - 42.5°)	Inlet	55	62	67	73	73	74	76	67	81
BOX HBF 63 T4/T8 0,8/0,2kW (A5:6) F400 (750 RPM - 25°)	Inlet	39	48	53	62	62	61	62	57	68
BOX HBF 63 T4/T8 0,8/0,2kW (A5:6) F400 (1500 RPM - 25°)	Inlet	54	63	68	77	77	76	77	72	83
BOX HBF 63 T4/T8 1,2/0,3kW (A5:6) F400 (750 RPM - 30°)	Inlet	42	50	56	62	62	61	64	59	69
BOX HBF 63 T4/T8 1,2/0,3kW (A5:6) F400 (1500 RPM - 30°)	Inlet	57	65	71	77	77	76	79	74	84
BOX HBF 63 T4/T8 1,6/0,4kW (A5:6) F400 (750 RPM - 35°)	Inlet	40	49	54	57	58	57	61	55	65
BOX HBF 63 T4/T8 1,6/0,4kW (A5:6) F400 (1500 RPM - 35°)	Inlet	56	64	69	72	73	73	76	70	80
BOX HBF 63 T4/T8 1,6/0,4kW (A5:6) F400 (750 RPM - 32.5°)	Inlet	41	49	55	59	60	59	62	57	67
BOX HBF 63 T4/T8 1,6/0,4kW (A5:6) F400 (1500 RPM - 32.5°)	Inlet	56	65	70	74	75	74	77	72	82

		Sound power Lw dB (A)								
Model		63 Hz	125 Hz	250 Hz	500 Hz	1000 Hz	2000 Hz	4000 Hz	8000 Hz	Total
BOX HBF 63 T4/T8 2,2/0,37kW (A5:6) F400 (750 RPM - 37.5°)	Inlet	41	49	54	58	59	59	61	55	66
BOX HBF 63 T4/T8 2,2/0,37kW (A5:6) F400 (750 RPM - 40°)	Inlet	42	49	54	59	59	60	62	55	67
BOX HBF 63 T4/T8 2,2/0,37kW (A5:6) F400 (1500 RPM - 37.5°)	Inlet	56	64	69	73	74	74	76	70	81
BOX HBF 63 T4/T8 2,2/0,37kW (A5:6) F400 (1500 RPM - 40°)	Inlet	57	64	69	74	75	75	77	70	82
BOX HBF 71 T4/T8 0,8/0,2kW (A5:6) F400 (750 RPM - 20°)	Inlet	37	48	53	68	67	64	66	58	73
BOX HBF 71 T4/T8 0,8/0,2kW (A5:6) F400 (1500 RPM - 20°)	Inlet	52	63	68	83	82	79	81	73	88
BOX HBF 71 T4/T8 1,2/0,3kW (A5:6) F400 (750 RPM - 25°)	Inlet	41	48	53	66	65	64	66	57	72
BOX HBF 71 T4/T8 1,2/0,3kW (A5:6) F400 (1500 RPM - 25°)	Inlet	56	64	69	81	81	79	81	72	87
BOX HBF 71 T4/T8 1,6/0,4kW (A5:6) F400 (750 RPM - 30°)	Inlet	43	50	55	64	64	65	66	55	71
BOX HBF 71 T4/T8 1,6/0,4kW (A5:6) F400 (1500 RPM - 30°)	Inlet	58	65	70	79	79	80	81	70	86
BOX HBF 71 T4/T8 2,2/0,37kW (A5:6) F400 (750 RPM - 35°)	Inlet	44	51	56	58	62	64	65	54	69
BOX HBF 71 T4/T8 2,2/0,37kW (A5:6) F400 (750 RPM - 32.5°)	Inlet	43	50	55	61	63	65	65	55	70
BOX HBF 71 T4/T8 2,2/0,37kW (A5:6) F400 (1500 RPM - 35°)	Inlet	59	66	71	73	77	79	80	69	84
BOX HBF 71 T4/T8 2,2/0,37kW (A5:6) F400 (1500 RPM - 32.5°)	Inlet	59	66	71	76	78	80	81	70	85
BOX HBF 71 T4/T8 3/0,55kW (A5:6) F400 (750 RPM - 40°)	Inlet	49	55	61	63	66	67	68	58	73
BOX HBF 71 T4/T8 3/0,55kW (A5:6) F400 (750 RPM - 37.5°)	Inlet	47	53	59	61	64	66	67	56	71
BOX HBF 71 T4/T8 3/0,55kW (A5:6) F400 (1500 RPM - 40°)	Inlet	64	70	76	78	81	82	83	73	88
BOX HBF 71 T4/T8 3/0,55kW (A5:6) F400 (1500 RPM - 37.5°)	Inlet	62	68	74	76	79	81	82	71	86
BOX HBF 80 T4/T8 3/0,55kW (A5:6) F400 (750 RPM - 35°)	Inlet	44	51	56	61	64	64	68	58	71
BOX HBF 80 T4/T8 3/0,55kW (A5:6) F400 (1500 RPM - 35°)	Inlet	59	66	71	76	79	79	83	73	86
BOX HBF 80 T4/T8 3/0,55kW (A5:6) F400 (750 RPM - 32.5°)	Inlet	45	52	57	63	66	66	70	61	73
BOX HBF 80 T4/T8 3/0,55kW (A5:6) F400 (1500 RPM - 32.5°)	Inlet	60	67	72	78	82	81	85	77	88
BOX HBF 80 T4/T8 3/0,55kW (A5:6) F400 (750 RPM - 30°)	Inlet	46	53	58	65	69	68	71	65	76

Sound power Lw dB (A)										
Model		63 Hz	125 Hz	250 Hz	500 Hz	1000 Hz	2000 Hz	4000 Hz	8000 Hz	Total
BOX HBF 80 T4/T8 3/0,55kW (A5:6) F400 (1500 RPM - 30°)	Inlet	61	68	73	80	84	83	87	80	91
BOX HBF 80 T4/T8 4/0,75kW (A5:6) F400 (750 RPM - 37.5°)	Inlet	46	53	58	62	65	65	68	58	72
BOX HBF 80 T4/T8 4/0,75kW (A5:6) F400 (1500 RPM - 37.5°)	Inlet	61	68	73	77	80	80	83	73	87
BOX HBF 80 T4/T8 4/0,75kW (A5:6) F400 (750 RPM - 40°)	Inlet	48	55	60	64	66	66	67	58	73
BOX HBF 80 T4/T8 4/0,75kW (A5:6) F400 (1500 RPM - 40°)	Inlet	63	70	75	79	81	81	83	73	88
BOX HBF 90 T4/T8 2,8/0,7kW (A3:4) F400 (1420 RPM - 22°)	Inlet	58	66	71	80	84	84	83	74	89
BOX HBF 90 T4/T8 2,8/0,7kW (A3:4) F400 (1420 RPM - 20°)	Inlet	54	65	70	81	85	85	83	75	90
BOX HBF 90 T4/T8 2,8/0,7kW (A3:4) F400 (720 RPM - 22°)	Inlet	42	50	55	64	68	68	67	59	73
BOX HBF 90 T4/T8 2,8/0,7kW (A3:4) F400 (720 RPM - 20°)	Inlet	38	49	54	65	69	69	67	59	74
BOX HBF 90 T4/T8 4/0,75kW (A3:4) F400 (1420 RPM - 26°)	Inlet	61	68	73	80	82	82	81	73	88
BOX HBF 90 T4/T8 4/0,75kW (A3:4) F400 (1420 RPM - 24°)	Inlet	60	67	72	80	83	83	82	74	88
BOX HBF 90 T4/T8 4/0,75kW (A3:4) F400 (720 RPM - 26°)	Inlet	45	52	57	64	66	66	65	57	72
BOX HBF 90 T4/T8 4/0,75kW (A3:4) F400 (720 RPM - 24°)	Inlet	44	51	56	64	67	67	66	58	72
BOX HBF 90 T4/T8 5,5/1,1kW (A3:4) F400 (1420 RPM - 32°)	Inlet	63	70	75	79	80	80	80	72	86
BOX HBF 90 T4/T8 5,5/1,1kW (A3:4) F400 (1420 RPM - 30°)	Inlet	63	70	75	80	80	80	80	72	86
BOX HBF 90 T4/T8 5,5/1,1kW (A3:4) F400 (1420 RPM - 28°)	Inlet	62	69	74	80	81	81	81	73	87
BOX HBF 90 T4/T8 5,5/1,1kW (A3:4) F400 (720 RPM - 32°)	Inlet	47	54	59	63	64	64	64	56	70
BOX HBF 90 T4/T8 5,5/1,1kW (A3:4) F400 (720 RPM - 30°)	Inlet	48	55	60	64	64	64	64	56	71
BOX HBF 90 T4/T8 5,5/1,1kW (A3:4) F400 (720 RPM - 28°)	Inlet	46	53	58	64	65	65	65	57	71
BOX HBF 90 T4/T8 5,5/1,1kW (A3:8) F400 (1420 RPM - 22°)	Inlet	66	77	85	87	89	84	85	75	94
BOX HBF 90 T4/T8 5,5/1,1kW (A3:8) F400 (1420 RPM - 20°)	Inlet	66	78	87	88	90	84	85	75	95
BOX HBF 90 T4/T8 5,5/1,1kW (A3:8) F400 (720 RPM - 22°)	Inlet	50	61	69	71	73	69	69	59	78
BOX HBF 90 T4/T8 5,5/1,1kW (A3:8) F400 (720 RPM - 20°)	Inlet	50	62	71	72	74	68	69	59	79



		Sound power Lw dB (A)								
Model		63 Hz	125 Hz	250 Hz	500 Hz	1000 Hz	2000 Hz	4000 Hz	8000 Hz	Total
BOX HBF 90 T4/T8 7,5/1,5kW (A3:4) F400 (1420 RPM - 38°)	Inlet	64	71	76	79	82	81	80	73	88
BOX HBF 90 T4/T8 7,5/1,5kW (A3:4) F400 (1420 RPM - 36°)	Inlet	63	70	75	78	81	81	79	71	87
BOX HBF 90 T4/T8 7,5/1,5kW (A3:4) F400 (1420 RPM - 34°)	Inlet	62	69	74	78	80	81	79	71	86
BOX HBF 90 T4/T8 7,5/1,5kW (A3:4) F400 (1420 RPM - 32°)	Inlet	63	70	75	79	80	80	80	72	86
BOX HBF 90 T4/T8 7,5/1,5kW (A3:4) F400 (720 RPM - 38°)	Inlet	48	55	60	63	66	66	64	57	72
BOX HBF 90 T4/T8 7,5/1,5kW (A3:4) F400 (720 RPM - 36°)	Inlet	47	54	59	63	65	65	64	55	71
BOX HBF 90 T4/T8 7,5/1,5kW (A3:4) F400 (720 RPM - 34°)	Inlet	47	54	59	63	64	65	63	55	70
BOX HBF 90 T4/T8 7,5/1,5kW (A3:4) F400 (720 RPM - 32°)	Inlet	47	54	59	63	64	64	64	56	70
BOX HBF 90 T4/T8 7,5/1,5kW (A3:8) F400 (1420 RPM - 28°)	Inlet	67	73	79	84	86	85	84	76	91
BOX HBF 90 T4/T8 7,5/1,5kW (A3:8) F400 (1420 RPM - 26°)	Inlet	67	75	81	85	87	85	85	76	92
BOX HBF 90 T4/T8 7,5/1,5kW (A3:8) F400 (1420 RPM - 24°)	Inlet	66	76	83	86	88	85	85	75	93
BOX HBF 90 T4/T8 7,5/1,5kW (A3:8) F400 (720 RPM - 28°)	Inlet	51	57	63	68	70	69	68	60	76
BOX HBF 90 T4/T8 7,5/1,5kW (A3:8) F400 (720 RPM - 26°)	Inlet	51	59	65	69	71	69	69	60	76
BOX HBF 90 T4/T8 7,5/1,5kW (A3:8) F400 (720 RPM - 24°)	Inlet	51	60	67	70	72	69	69	60	77
BOX HBF 90 T4/T8 11/3kW (A3:4) F400 (1420 RPM - 40°)	Inlet	65	72	77	80	84	82	81	74	88
BOX HBF 90 T4/T8 11/3kW (A3:4) F400 (720 RPM - 40°)	Inlet	49	56	61	64	68	66	65	58	72
BOX HBF 90 T4/T8 11/3kW (A3:8) F400 (1420 RPM - 36°)	Inlet	64	71	76	80	84	84	82	74	89
BOX HBF 90 T4/T8 11/3kW (A3:8) F400 (1420 RPM - 34°)	Inlet	64	71	76	81	84	84	82	74	89
BOX HBF 90 T4/T8 11/3kW (A3:8) F400 (1420 RPM - 32°)	Inlet	64	71	76	82	84	84	83	75	90
BOX HBF 90 T4/T8 11/3kW (A3:8) F400 (1420 RPM - 30°)	Inlet	65	72	77	83	85	85	84	76	91
BOX HBF 90 T4/T8 11/3kW (A3:8) F400 (720 RPM - 36°)	Inlet	48	55	60	64	68	68	66	58	73
BOX HBF 90 T4/T8 11/3kW (A3:8) F400 (720 RPM - 34°)	Inlet	48	55	60	65	68	68	66	58	73
BOX HBF 90 T4/T8 11/3kW (A3:8) F400 (720 RPM - 32°)	Inlet	49	56	61	66	68	69	67	59	74

		Sound power Lw dB (A)								
Model		63 Hz	125 Hz	250 Hz	500 Hz	1000 Hz	2000 Hz	4000 Hz	8000 Hz	Total
BOX HBF 90 T4/T8 11/3kW (A3:8) F400 (720 RPM - 30°)	Inlet	49	56	61	67	69	69	68	60	75
BOX HBF 90 T4/T8 14/3,5kW (A3:8) F400 (1420 RPM - 40°)	Inlet	68	75	80	81	85	84	81	75	90
BOX HBF 90 T4/T8 14/3,5kW (A3:8) F400 (1420 RPM - 38°)	Inlet	66	73	78	81	84	84	81	74	89
BOX HBF 90 T4/T8 14/3,5kW (A3:8) F400 (720 RPM - 40°)	Inlet	52	59	64	65	69	68	65	59	74
BOX HBF 90 T4/T8 14/3,5kW (A3:8) F400 (720 RPM - 38°)	Inlet	50	57	62	65	68	68	66	58	74
BOX HBF 100 T4/T8 5,5/1,1kW (A3:4) F400 (1420 RPM - 26°)	Inlet	64	72	78	84	87	88	90	85	94
BOX HBF 100 T4/T8 5,5/1,1kW (A3:4) F400 (1420 RPM - 24°)	Inlet	64	73	78	84	88	89	90	86	95
BOX HBF 100 T4/T8 5,5/1,1kW (A3:4) F400 (1420 RPM - 22°)	Inlet	63	73	79	85	88	89	90	87	95
BOX HBF 100 T4/T8 5,5/1,1kW (A3:4) F400 (1420 RPM - 20°)	Inlet	63	73	78	85	88	89	90	87	95
BOX HBF 100 T4/T8 5,5/1,1kW (A3:4) F400 (720 RPM - 26°)	Inlet	48	56	62	68	71	72	74	69	79
BOX HBF 100 T4/T8 5,5/1,1kW (A3:4) F400 (720 RPM - 24°)	Inlet	48	57	63	69	72	73	74	70	79
BOX HBF 100 T4/T8 5,5/1,1kW (A3:4) F400 (720 RPM - 22°)	Inlet	47	57	63	69	73	73	74	71	79
BOX HBF 100 T4/T8 5,5/1,1kW (A3:4) F400 (720 RPM - 20°)	Inlet	47	57	63	69	73	73	74	71	79
BOX HBF 100 T4/T8 7,5/1,5kW (A3:4) F400 (1420 RPM - 30°)	Inlet	65	71	78	83	87	88	90	83	94
BOX HBF 100 T4/T8 7,5/1,5kW (A3:4) F400 (1420 RPM - 28°)	Inlet	64	72	78	83	87	88	90	84	94
BOX HBF 100 T4/T8 7,5/1,5kW (A3:4) F400 (720 RPM - 30°)	Inlet	49	56	62	67	71	72	74	67	78
BOX HBF 100 T4/T8 7,5/1,5kW (A3:4) F400 (720 RPM - 28°)	Inlet	48	56	62	68	71	72	74	68	78
BOX HBF 100 T4/T8 7,5/1,5kW (A3:8) F400 (1420 RPM - 20°)	Inlet	69	78	89	99	97	96	97	92	104
BOX HBF 100 T4/T8 7,5/1,5kW (A3:8) F400 (720 RPM - 20°)	Inlet	53	62	73	83	81	80	81	76	88
BOX HBF 100 T4/T8 11/3kW (A3:4) F400 (1420 RPM - 38°)	Inlet	65	71	78	83	86	87	89	82	93
BOX HBF 100 T4/T8 11/3kW (A3:4) F400 (1420 RPM - 36°)	Inlet	66	70	78	83	85	87	88	82	93
BOX HBF 100 T4/T8 11/3kW (A3:4) F400 (1420 RPM - 34°)	Inlet	66	70	78	82	85	87	88	82	93
BOX HBF 100 T4/T8 11/3kW (A3:4) F400 (1420 RPM - 32°)	Inlet	65	71	78	83	86	87	89	83	93

		Sound power Lw dB (A)								
Model		63 Hz	125 Hz	250 Hz	500 Hz	1000 Hz	2000 Hz	4000 Hz	8000 Hz	Total
BOX HBF 100 T4/T8 11/3kW (A3:4) F400 (720 RPM - 38°)	Inlet	49	55	62	67	70	71	73	66	77
BOX HBF 100 T4/T8 11/3kW (A3:4) F400 (720 RPM - 36°)	Inlet	50	54	62	67	69	71	72	66	77
BOX HBF 100 T4/T8 11/3kW (A3:4) F400 (720 RPM - 34°)	Inlet	50	54	62	66	69	71	73	66	77
BOX HBF 100 T4/T8 11/3kW (A3:4) F400 (720 RPM - 32°)	Inlet	49	55	62	67	70	71	73	67	77
BOX HBF 100 T4/T8 11/3kW (A3:8) F400 (1420 RPM - 28°)	Inlet	69	76	84	90	93	92	93	88	99
BOX HBF 100 T4/T8 11/3kW (A3:8) F400 (1420 RPM - 26°)	Inlet	69	76	85	92	93	93	94	89	100
BOX HBF 100 T4/T8 11/3kW (A3:8) F400 (1420 RPM - 24°)	Inlet	69	76	86	94	94	94	95	90	101
BOX HBF 100 T4/T8 11/3kW (A3:8) F400 (1420 RPM - 22°)	Inlet	69	77	88	97	96	95	96	91	103
BOX HBF 100 T4/T8 11/3kW (A3:8) F400 (720 RPM - 28°)	Inlet	53	60	68	74	77	77	77	72	83
BOX HBF 100 T4/T8 11/3kW (A3:8) F400 (720 RPM - 26°)	Inlet	53	60	69	76	77	77	78	73	84
BOX HBF 100 T4/T8 11/3kW (A3:8) F400 (720 RPM - 24°)	Inlet	53	61	70	78	79	78	79	74	85
BOX HBF 100 T4/T8 11/3kW (A3:8) F400 (720 RPM - 22°)	Inlet	53	61	72	81	80	79	80	75	87
BOX HBF 100 T4/T8 14/3,5kW (A3:4) F400 (1420 RPM - 40°)	Inlet	65	72	78	84	87	88	89	83	94
BOX HBF 100 T4/T8 14/3,5kW (A3:4) F400 (720 RPM - 40°)	Inlet	49	56	63	68	72	72	73	67	78
BOX HBF 100 T4/T8 14/3,5kW (A3:8) F400 (1420 RPM - 32°)	Inlet	68	76	81	87	90	91	92	86	97
BOX HBF 100 T4/T8 14/3,5kW (A3:8) F400 (1420 RPM - 30°)	Inlet	69	76	83	88	92	92	93	87	98
BOX HBF 100 T4/T8 14/3,5kW (A3:8) F400 (720 RPM - 32°)	Inlet	52	60	65	71	74	75	76	70	81
BOX HBF 100 T4/T8 14/3,5kW (A3:8) F400 (720 RPM - 30°)	Inlet	53	60	67	72	76	76	77	71	82
BOX HBF 100 T4/T8 17/4,3kW (A3:8) F400 (1420 RPM - 36°)	Inlet	67	74	79	84	88	90	91	84	96
BOX HBF 100 T4/T8 17/4,3kW (A3:8) F400 (1420 RPM - 34°)	Inlet	68	75	80	85	89	90	91	85	96
BOX HBF 100 T4/T8 17/4,3kW (A3:8) F400 (720 RPM - 36°)	Inlet	51	58	63	68	72	74	75	69	80
BOX HBF 100 T4/T8 17/4,3kW (A3:8) F400 (720 RPM - 34°)	Inlet	52	59	64	69	73	74	75	69	80
BOX HBF 100 T4/T8 20/5kW (A3:8) F400 (1420 RPM - 40°)	Inlet	68	76	81	86	89	91	92	86	97

		Sound power Lw dB (A)								
Model		63 Hz	125 Hz	250 Hz	500 Hz	1000 Hz	2000 Hz	4000 Hz	8000 Hz	Total
BOX HBF 100 T4/T8 20/5kW (A3:8) F400 (1420 RPM - 38°)	Inlet	68	75	80	85	89	91	91	85	96
BOX HBF 100 T4/T8 20/5kW (A3:8) F400 (720 RPM - 40°)	Inlet	53	60	65	70	73	75	76	70	81
BOX HBF 100 T4/T8 20/5kW (A3:8) F400 (720 RPM - 38°)	Inlet	52	59	64	69	73	75	75	69	80
BOX HBF 112 T4/T8 5,5/1,1kW (A3:4) F400 (1420 RPM - 20°)	Inlet	63	75	80	87	91	91	93	89	98
BOX HBF 112 T4/T8 5,5/1,1kW (A3:4) F400 (720 RPM - 20°)	Inlet	47	59	64	71	75	75	77	73	82
BOX HBF 112 T4/T8 7,5/1,5kW (A3:4) F400 (1420 RPM - 24°)	Inlet	66	75	80	87	90	91	93	88	98
BOX HBF 112 T4/T8 7,5/1,5kW (A3:4) F400 (1420 RPM - 22°)	Inlet	65	76	81	87	91	92	93	89	99
BOX HBF 112 T4/T8 7,5/1,5kW (A3:4) F400 (720 RPM - 24°)	Inlet	50	59	64	71	74	75	77	72	82
BOX HBF 112 T4/T8 7,5/1,5kW (A3:4) F400 (720 RPM - 22°)	Inlet	49	60	65	71	75	76	78	73	83
BOX HBF 112 T4/T8 11/3kW (A3:4) F400 (1420 RPM - 32°)	Inlet	67	74	79	84	88	89	91	84	95
BOX HBF 112 T4/T8 11/3kW (A3:4) F400 (1420 RPM - 30°)	Inlet	68	75	80	85	89	90	91	85	96
BOX HBF 112 T4/T8 11/3kW (A3:4) F400 (1420 RPM - 28°)	Inlet	68	75	80	86	89	90	92	86	96
BOX HBF 112 T4/T8 11/3kW (A3:4) F400 (1420 RPM - 26°)	Inlet	67	75	80	86	90	91	92	87	97
BOX HBF 112 T4/T8 11/3kW (A3:4) F400 (720 RPM - 32°)	Inlet	52	58	64	69	72	73	75	68	79
BOX HBF 112 T4/T8 11/3kW (A3:4) F400 (720 RPM - 30°)	Inlet	52	59	64	69	73	74	75	69	80
BOX HBF 112 T4/T8 11/3kW (A3:4) F400 (720 RPM - 28°)	Inlet	52	59	64	70	73	74	76	70	80
BOX HBF 112 T4/T8 11/3kW (A3:4) F400 (720 RPM - 26°)	Inlet	51	59	64	70	74	75	76	71	81
BOX HBF 112 T4/T8 11/3kW (A3:8) F400 (1420 RPM - 20°)	Inlet	70	79	89	98	98	100	100	94	106
BOX HBF 112 T4/T8 11/3kW (A3:8) F400 (720 RPM - 20°)	Inlet	54	63	73	82	82	84	84	78	90
BOX HBF 112 T4/T8 14/3,5kW (A3:4) F400 (1420 RPM - 36°)	Inlet	68	73	80	84	87	89	90	83	95
BOX HBF 112 T4/T8 14/3,5kW (A3:4) F400 (1420 RPM - 34°)	Inlet	67	73	79	84	87	89	90	83	95
BOX HBF 112 T4/T8 14/3,5kW (A3:4) F400 (720 RPM - 36°)	Inlet	52	57	64	68	71	73	74	67	79
BOX HBF 112 T4/T8 14/3,5kW (A3:4) F400 (720 RPM - 34°)	Inlet	51	57	63	68	71	73	74	67	79

		Sound power Lw dB (A)								
Model		63 Hz	125 Hz	250 Hz	500 Hz	1000 Hz	2000 Hz	4000 Hz	8000 Hz	Total
BOX HBF 112 T4/T8 14/3,5kW (A3:8) F400 (1420 RPM - 26°)	Inlet	71	78	86	93	95	97	97	91	103
BOX HBF 112 T4/T8 14/3,5kW (A3:8) F400 (1420 RPM - 24°)	Inlet	70	78	87	94	96	98	98	92	103
BOX HBF 112 T4/T8 14/3,5kW (A3:8) F400 (1420 RPM - 22°)	Inlet	70	78	88	96	97	99	99	93	104
BOX HBF 112 T4/T8 14/3,5kW (A3:8) F400 (720 RPM - 26°)	Inlet	55	62	70	77	80	81	81	75	87
BOX HBF 112 T4/T8 14/3,5kW (A3:8) F400 (720 RPM - 24°)	Inlet	54	62	71	78	80	82	82	76	87
BOX HBF 112 T4/T8 14/3,5kW (A3:8) F400 (720 RPM - 22°)	Inlet	54	62	72	80	81	83	83	77	88
BOX HBF 112 T4/T8 17/4,3kW (A3:4) F400 (1420 RPM - 40°)	Inlet	69	76	81	86	88	90	91	84	96
BOX HBF 112 T4/T8 17/4,3kW (A3:4) F400 (1420 RPM - 38°)	Inlet	68	74	80	85	88	89	90	84	95
BOX HBF 112 T4/T8 17/4,3kW (A3:4) F400 (720 RPM - 40°)	Inlet	53	60	65	70	73	74	75	68	80
BOX HBF 112 T4/T8 17/4,3kW (A3:4) F400 (720 RPM - 38°)	Inlet	52	58	64	69	72	73	75	68	79
BOX HBF 112 T4/T8 17/4,3kW (A3:8) F400 (1420 RPM - 30°)	Inlet	71	77	84	90	94	96	96	90	101
BOX HBF 112 T4/T8 17/4,3kW (A3:8) F400 (1420 RPM - 28°)	Inlet	71	78	85	91	95	96	96	91	102
BOX HBF 112 T4/T8 17/4,3kW (A3:8) F400 (720 RPM - 30°)	Inlet	55	62	69	74	78	80	80	74	85
BOX HBF 112 T4/T8 17/4,3kW (A3:8) F400 (720 RPM - 28°)	Inlet	55	62	69	75	79	80	80	75	86
BOX HBF 112 T4/T8 20/5kW (A3:8) F400 (1420 RPM - 32°)	Inlet	71	78	83	88	93	94	94	88	100
BOX HBF 112 T4/T8 20/5kW (A3:8) F400 (720 RPM - 32°)	Inlet	55	62	67	73	77	78	78	72	84
BOX HBF 112 T4/T8 28/6,5kW (A3:8) F400 (1420 RPM - 40°)	Inlet	71	78	83	87	91	93	92	87	98
BOX HBF 112 T4/T8 28/6,5kW (A3:8) F400 (1420 RPM - 38°)	Inlet	70	77	82	87	91	93	92	86	98
BOX HBF 112 T4/T8 28/6,5kW (A3:8) F400 (1420 RPM - 36°)	Inlet	70	77	82	87	90	92	92	86	98
BOX HBF 112 T4/T8 28/6,5kW (A3:8) F400 (1420 RPM - 34°)	Inlet	70	77	82	87	91	93	93	86	98
BOX HBF 112 T4/T8 28/6,5kW (A3:8) F400 (720 RPM - 40°)	Inlet	55	62	67	71	75	77	77	71	82
BOX HBF 112 T4/T8 28/6,5kW (A3:8) F400 (720 RPM - 38°)	Inlet	54	61	66	71	75	77	77	70	82
BOX HBF 112 T4/T8 28/6,5kW (A3:8) F400 (720 RPM - 36°)	Inlet	54	61	66	71	74	76	77	70	82

		Sound power Lw dB (A)								
Model		63 Hz	125 Hz	250 Hz	500 Hz	1000 Hz	2000 Hz	4000 Hz	8000 Hz	Total
BOX HBF 112 T4/T8 28/6,5kW (A3:8) F400 (720 RPM - 34°)	Inlet	54	61	66	71	75	77	77	70	82
BOX HBF 125 T4/T8 11/3kW (A3:4) F400 (1420 RPM - 22°)	Inlet	72	83	88	95	99	100	102	98	106
BOX HBF 125 T4/T8 11/3kW (A3:4) F400 (1420 RPM - 20°)	Inlet	69	82	87	95	99	99	101	98	106
BOX HBF 125 T4/T8 11/3kW (A3:4) F400 (720 RPM - 22°)	Inlet	56	67	72	79	83	84	86	82	90
BOX HBF 125 T4/T8 11/3kW (A3:4) F400 (720 RPM - 20°)	Inlet	53	66	71	79	83	83	85	82	90
BOX HBF 125 T4/T8 14/3,5kW (A3:4) F400 (1420 RPM - 26°)	Inlet	73	81	86	91	95	96	98	92	103
BOX HBF 125 T4/T8 14/3,5kW (A3:4) F400 (1420 RPM - 24°)	Inlet	72	82	87	93	97	98	100	95	104
BOX HBF 125 T4/T8 14/3,5kW (A3:4) F400 (720 RPM - 26°)	Inlet	57	65	70	75	79	80	82	77	87
BOX HBF 125 T4/T8 14/3,5kW (A3:4) F400 (720 RPM - 24°)	Inlet	56	66	71	77	81	82	84	79	88
BOX HBF 125 T4/T8 17/4,3kW (A3:4) F400 (1420 RPM - 30°)	Inlet	71	78	83	88	92	93	94	88	99
BOX HBF 125 T4/T8 17/4,3kW (A3:4) F400 (1420 RPM - 28°)	Inlet	72	79	84	90	93	95	96	90	101
BOX HBF 125 T4/T8 17/4,3kW (A3:4) F400 (720 RPM - 30°)	Inlet	55	62	67	72	76	77	78	72	83
BOX HBF 125 T4/T8 17/4,3kW (A3:4) F400 (720 RPM - 28°)	Inlet	57	64	69	74	77	79	80	74	85
BOX HBF 125 T4/T8 20/5kW (A3:4) F400 (1420 RPM - 34°)	Inlet	70	77	82	87	90	92	93	85	98
BOX HBF 125 T4/T8 20/5kW (A3:4) F400 (1420 RPM - 32°)	Inlet	71	78	83	87	91	93	93	87	99
BOX HBF 125 T4/T8 20/5kW (A3:4) F400 (720 RPM - 34°)	Inlet	55	62	67	71	74	76	77	69	82
BOX HBF 125 T4/T8 20/5kW (A3:4) F400 (720 RPM - 32°)	Inlet	55	62	67	72	75	77	78	71	83
BOX HBF 125 T4/T8 20/5kW (A3:8) F400 (1420 RPM - 24°)	Inlet	75	82	89	97	103	105	105	99	110
BOX HBF 125 T4/T8 20/5kW (A3:8) F400 (1420 RPM - 22°)	Inlet	76	83	90	99	104	107	106	101	111
BOX HBF 125 T4/T8 20/5kW (A3:8) F400 (1420 RPM - 20°)	Inlet	75	83	90	100	105	108	107	102	112
BOX HBF 125 T4/T8 20/5kW (A3:8) F400 (720 RPM - 24°)	Inlet	59	67	73	81	87	89	89	83	94
BOX HBF 125 T4/T8 20/5kW (A3:8) F400 (720 RPM - 22°)	Inlet	60	67	74	83	88	91	90	85	95
BOX HBF 125 T4/T8 20/5kW (A3:8) F400 (720 RPM - 20°)	Inlet	59	68	75	84	89	92	91	86	96

Sound power Lw dB (A)										
Model		63 Hz	125 Hz	250 Hz	500 Hz	1000 Hz	2000 Hz	4000 Hz	8000 Hz	Total
BOX HBF 125 T4/T8 28/6,5kW (A3:4) F400 (1420 RPM - 40°)	Inlet	72	79	84	88	90	93	93	86	99
BOX HBF 125 T4/T8 28/6,5kW (A3:4) F400 (1420 RPM - 38°)	Inlet	71	78	83	88	90	92	93	86	98
BOX HBF 125 T4/T8 28/6,5kW (A3:4) F400 (1420 RPM - 36°)	Inlet	71	78	83	87	90	92	93	85	98
BOX HBF 125 T4/T8 28/6,5kW (A3:4) F400 (720 RPM - 40°)	Inlet	56	63	68	72	75	77	77	70	83
BOX HBF 125 T4/T8 28/6,5kW (A3:4) F400 (720 RPM - 38°)	Inlet	55	62	67	72	74	76	77	70	82
BOX HBF 125 T4/T8 28/6,5kW (A3:4) F400 (720 RPM - 36°)	Inlet	55	62	67	71	74	76	77	69	82
BOX HBF 125 T4/T8 28/6,5kW (A3:8) F400 (1420 RPM - 30°)	Inlet	74	80	87	93	98	100	101	94	105
BOX HBF 125 T4/T8 28/6,5kW (A3:8) F400 (1420 RPM - 28°)	Inlet	75	81	88	94	99	102	102	95	107
BOX HBF 125 T4/T8 28/6,5kW (A3:8) F400 (1420 RPM - 26°)	Inlet	75	82	88	95	101	103	103	97	108
BOX HBF 125 T4/T8 28/6,5kW (A3:8) F400 (720 RPM - 30°)	Inlet	59	64	71	77	82	84	85	78	89
BOX HBF 125 T4/T8 28/6,5kW (A3:8) F400 (720 RPM - 28°)	Inlet	59	65	72	78	83	86	86	79	91
BOX HBF 125 T4/T8 28/6,5kW (A3:8) F400 (720 RPM - 26°)	Inlet	59	66	72	79	85	87	87	81	92
BOX HBF 125 T4/T8 37/9,2kW (A3:8) F400 (1420 RPM - 36°)	Inlet	74	80	86	90	93	95	95	88	101
BOX HBF 125 T4/T8 37/9,2kW (A3:8) F400 (1420 RPM - 34°)	Inlet	74	80	86	91	94	96	97	89	102
BOX HBF 125 T4/T8 37/9,2kW (A3:8) F400 (1420 RPM - 32°)	Inlet	74	80	86	92	96	99	99	91	104
BOX HBF 125 T4/T8 37/9,2kW (A3:8) F400 (720 RPM - 36°)	Inlet	58	65	70	74	78	80	79	72	85
BOX HBF 125 T4/T8 37/9,2kW (A3:8) F400 (720 RPM - 34°)	Inlet	58	65	70	75	78	81	81	73	86
BOX HBF 125 T4/T8 37/9,2kW (A3:8) F400 (720 RPM - 32°)	Inlet	58	64	70	76	80	83	83	76	88
BOX HBF 125 T4/T8 44/11kW (A3:8) F400 (1420 RPM - 40°)	Inlet	73	80	85	90	93	95	94	87	100
BOX HBF 125 T4/T8 44/11kW (A3:8) F400 (1420 RPM - 38°)	Inlet	73	80	85	90	93	95	94	88	101
BOX HBF 125 T4/T8 44/11kW (A3:8) F400 (720 RPM - 40°)	Inlet	57	64	69	74	77	79	78	71	84
BOX HBF 125 T4/T8 44/11kW (A3:8) F400 (720 RPM - 38°)	Inlet	57	64	69	74	77	79	79	72	85



## erp data

ERP	
Fan type	Axial fan
Installation category	A
Efficiency category	Static
The fan has to be installed with FSC	No

## ERP / 4 poles

Model	Motor power (kW)	Maximum efficiency point data						
		Max. efficiency (%)	Efficiency grade (N) (N)	Air Flow (m3/h)	Ps (Pa)	Pabs (kW)	speed (rpm)	Specific ratio
BOX HBF 45 T4 0,75kW (A5:6) F400 (°)	0,75	25,22	34,25	3.938,40	91,48	0,37	1404	1,00
BOX HBF 50 T4 0,75kW (A5:6) F400 (°)	0,75	33,75	41,93	5.631,13	108,38	0,51	1404	1,00
BOX HBF 56 T4 0,75kW (A5:6) F400 (°)	0,75	38,49	46,08	5.286,46	156,65	0,63	1404	1,00
BOX HBF 56 T4 0,75kW (A5:6) F400 (°)	0,75	38,91	45,71	6.799,71	163,76	0,84	1404	1,00
BOX HBF 56 T4 0,75kW (A5:6) F400 (°)	0,75	40,36	47,48	6.377,29	162,70	0,75	1404	1,00
BOX HBF 56 T4 1,1kW (A5:6) F400 (°)	1,1	35,94	41,99	7.864,11	175,27	1,11	1392	1,00
BOX HBF 56 T4 1,1kW (A5:6) F400 (°)	1,1	37,33	43,85	7.198,19	163,79	0,93	1392	1,00
BOX HBF 56 T4 1,5kW (A5:6) F400 (°)	1,5	35,35	41	8.575,19	185,04	1,28	1410	1,00
BOX HBF 56 T4 1,5kW (A5:6) F400 (°)	1,5	35,43	40,72	9.299,95	193,09	1,46	1410	1,00
BOX HBF 63 T4 0,75kW (A5:6) F400 (°)	0,75	46,63	53,25	7.384,78	192,08	0,90	1404	1,00
BOX HBF 63 T4 1,1kW (A5:6) F400 (°)	1,1	46,52	52,17	9.056,31	221,36	1,28	1392	1,00
BOX HBF 63 T4 1,5kW (A5:6) F400 (°)	1,5	42,12	47,20	10.066,20	229,21	1,58	1410	1,00
BOX HBF 63 T4 1,5kW (A5:6) F400 (°)	1,5	44,39	49,74	9.588,71	224,77	1,43	1410	1,00
BOX HBF 63 T4 2,2kW (A5:6) F400 (°)	2,2	40,03	44,74	10.830,65	229,31	1,81	1420	1,00
BOX HBF 63 T4 2,2kW (A5:6) F400 (°)	2,2	38,35	42,73	11.588,88	230,37	2,03	1420	1,00
BOX HBF 71 T4 0,75kW (A5:6) F400 (°)	0,75	47,01	53,39	7.908,74	201,69	0,98	1404	1,00
BOX HBF 71 T4 1,1kW (A5:6) F400 (°)	1,1	45,67	51,11	9.865,86	221,15	1,39	1392	1,00
BOX HBF 71 T4 1,5kW (A5:6) F400 (°)	1,5	46,22	50,95	11.855,32	240,58	1,80	1410	1,00
BOX HBF 71 T4 2,2kW (A5:6) F400 (°)	2,2	42,32	46,19	14.007,05	256,86	2,46	1420	1,00
BOX HBF 71 T4 2,2kW (A5:6) F400 (°)	2,2	43,85	48,11	12.922	248,26	2,13	1420	1,00
BOX HBF 71 T4 3kW (A5:6) F400 (°)	3	39,37	42,79	15.295,05	255,96	2,89	1420	1,00
BOX HBF 71 T4 3kW (A5:6) F400 (°)	3	40,72	44,36	14.637,66	255,51	2,67	1420	1,00
BOX HBF 80 T4 3kW (A5:6) F400 (°)	3	47,47	50,44	18.603,39	298,09	3,41	1420	1,00
BOX HBF 80 T4 3kW (A5:6) F400 (°)	3	49,89	53,19	17.421,07	297,07	3,02	1420	1,00
BOX HBF 80 T4 3kW (A5:6) F400 (°)	3	53,27	56,95	16.269,95	295,38	2,63	1420	1,00
BOX HBF 80 T4 4kW (A5:6) F400 (°)	4	46,01	48,67	20.008,80	305,30	3,81	1428	1,00
BOX HBF 80 T4 4kW (A5:6) F400 (°)	4	45,44	47,83	21.569,23	310,17	4,22	1428	1,00
BOX HBF 90 T4 3kW (A3:4) F400 (°)	3	48,40	51,64	16.269,79	312,06	3,09	1420	1,00



Model	Motor power (kW)	Maximum efficiency point data						
		Max. efficiency (%)	Efficiency grade (N) (N)	Air Flow (m3/h)	Ps (Pa)	Pabs (kW)	speed (rpm)	Specific ratio
BOX HBF 90 T4 3kW (A3:4) F400 (°)	3	49,88	53,58	14.806,82	298,15	2,61	1420	1,00
BOX HBF 90 T4 4kW (A3:4) F400 (°)	4	46,06	48,49	19.259,13	340,14	4,15	1440	1,00
BOX HBF 90 T4 4kW (A3:4) F400 (°)	4	47,50	50,34	17.768,06	326,89	3,58	1440	1,00
BOX HBF 90 T4 5,5kW (A3:4) F400 (°)	5,5	42,44	43,93	23.455,15	367,14	5,86	1460	1,00
BOX HBF 90 T4 5,5kW (A3:4) F400 (°)	5,5	43,92	45,63	22.345,93	367,81	5,41	1460	1,00
BOX HBF 90 T4 5,5kW (A3:4) F400 (°)	5,5	45,22	47,29	20.822,29	353,92	4,73	1460	1,00
BOX HBF 90 T4 5,5kW (A3:8) F400 (°)	5,5	46,56	47,96	19.242,52	472,46	6,05	1460	1,00
BOX HBF 90 T4 5,5kW (A3:8) F400 (°)	5,5	47,68	49,45	17.497,66	461,40	5,27	1460	1,00
BOX HBF 90 T4 5,5kW (A3:8) F400 (°)	5,5	48,67	50,84	15.786,74	450,04	4,57	1460	1,00
BOX HBF 90 T4 7,5kW (A3:4) F400 (°)	7,5	37,31	38,09	27.009,72	360,41	7,58	1455	1,00
BOX HBF 90 T4 7,5kW (A3:4) F400 (°)	7,5	39,50	40,55	25.787,41	364,05	6,88	1455	1,00
BOX HBF 90 T4 7,5kW (A3:4) F400 (°)	7,5	41,38	42,67	24.607,17	366,35	6,30	1455	1,00
BOX HBF 90 T4 7,5kW (A3:8) F400 (°)	7,5	45,05	45,76	22.907,92	496,52	7,76	1455	1,00
BOX HBF 90 T4 7,5kW (A3:8) F400 (°)	7,5	46,06	47,13	21.070,55	483,55	6,84	1455	1,00
BOX HBF 90 T4 11kW (A3:4) F400 (°)	11	35,47	36,01	28.252,71	356,23	8,28	1470	1,00
BOX HBF 90 T4 11kW (A3:8) F400 (°)	11	40,70	40,69	29.199,51	527,28	11,30	1470	1,00
BOX HBF 90 T4 11kW (A3:8) F400 (°)	11	41,82	41,88	27.753,29	520,19	10,39	1470	1,00
BOX HBF 90 T4 11kW (A3:8) F400 (°)	11	43,24	43,40	26.309,90	515,21	9,50	1470	1,00
BOX HBF 90 T4 11kW (A3:8) F400 (°)	11	44,52	44,93	24.798,94	510,53	8,67	1470	1,00
BOX HBF 90 T4 15kW (A3:8) F400 (°)	15	38,50	38,36	32.064,08	543,37	13,28	1465	1,00
BOX HBF 90 T4 15kW (A3:8) F400 (°)	15	39,99	39,92	30.693,75	535,39	12,16	1465	1,00
BOX HBF 100 T4 5,5kW (A3:4) F400 (°)	5,5	51,87	53,30	26.551,96	401	5,98	1460	1,00
BOX HBF 100 T4 5,5kW (A3:4) F400 (°)	5,5	53,50	55,28	24.581,71	393,08	5,28	1460	1,00
BOX HBF 100 T4 5,5kW (A3:4) F400 (°)	5,5	55,29	57,42	22.619,79	386,25	4,64	1460	1,00
BOX HBF 100 T4 5,5kW (A3:4) F400 (°)	5,5	56,41	58,86	20.842,55	377,22	4,11	1460	1,00
BOX HBF 100 T4 7,5kW (A3:4) F400 (°)	7,5	49,06	49,88	30.676,32	415,55	7,49	1455	1,00
BOX HBF 100 T4 7,5kW (A3:4) F400 (°)	7,5	50,77	51,90	28.592,36	409,27	6,67	1455	1,00
BOX HBF 100 T4 7,5kW (A3:8) F400 (°)	7,5	55,47	56,16	23.417,68	607,83	7,82	1455	1,00
BOX HBF 100 T4 11kW (A3:4) F400 (°)	11	41,52	41,52	37.883,88	424,19	11,15	1470	1,00
BOX HBF 100 T4 11kW (A3:4) F400 (°)	11	43,81	43,89	35.974,38	428,43	10,10	1470	1,00
BOX HBF 100 T4 11kW (A3:4) F400 (°)	11	45,92	46,20	34.144,20	427,62	9,11	1470	1,00
BOX HBF 100 T4 11kW (A3:4) F400 (°)	11	47,76	48,32	32.382,92	421,97	8,22	1470	1,00
BOX HBF 100 T4 11kW (A3:8) F400 (°)	11	51,03	51,01	31.641,86	617,34	11,55	1470	1,00
BOX HBF 100 T4 11kW (A3:8) F400 (°)	11	52,54	52,58	29.528,86	615,77	10,48	1470	1,00
BOX HBF 100 T4 11kW (A3:8) F400 (°)	11	53,94	54,11	27.456,87	612,59	9,47	1470	1,00
BOX HBF 100 T4 11kW (A3:8) F400 (°)	11	55,20	55,65	25.420,36	610,20	8,56	1470	1,00
BOX HBF 100 T4 15kW (A3:4) F400 (°)	15	39,45	39,38	39.773,65	420,72	12,24	1465	1,00
BOX HBF 100 T4 15kW (A3:8) F400 (°)	15	47,09	46,83	38.099,12	641,83	15,45	1465	1,00



Model	Motor power (kW)	Maximum efficiency point data						
		Max. efficiency (%)	Efficiency grade (N) (N)	Air Flow (m3/h)	Ps (Pa)	Pabs (kW)	speed (rpm)	Specific ratio
BOX HBF 100 T4 15kW (A3:8) F400 (°)	15	48,58	48,41	35.858,39	631,14	13,92	1465	1,00
BOX HBF 100 T4 15kW (A3:8) F400 (°)	15	50,05	49,95	33.667,23	620,57	12,57	1465	1,00
BOX HBF 100 T4 18,5kW (A3:8) F400 (°)	18,5	43,92	43,51	42.881,99	657,50	18,71	1465	1,00
BOX HBF 100 T4 18,5kW (A3:8) F400 (°)	18,5	45,47	45,14	40.435,64	650,15	17,04	1465	1,00
BOX HBF 100 T4 22kW (A3:8) F400 (°)	22	42,42	41,94	45.506,86	663,64	20,54	1465	1,00
BOX HBF 112 T4 5,5kW (A3:4) F400 (°)	5,5	58,57	60,07	25.650,99	454,24	5,82	1460	1,00
BOX HBF 112 T4 7,5kW (A3:4) F400 (°)	7,5	56,18	57,03	31.958,45	439,65	7,40	1455	1,00
BOX HBF 112 T4 7,5kW (A3:4) F400 (°)	7,5	57,62	58,79	28.722,21	445,68	6,56	1455	1,00
BOX HBF 112 T4 11kW (A3:4) F400 (°)	11	50,77	50,76	45.167,47	447,36	11,30	1470	1,00
BOX HBF 112 T4 11kW (A3:4) F400 (°)	11	52,52	52,59	42.650,78	440,51	10,20	1470	1,00
BOX HBF 112 T4 11kW (A3:4) F400 (°)	11	54,03	54,29	38.950,75	437	9,18	1470	1,00
BOX HBF 112 T4 11kW (A3:4) F400 (°)	11	55,47	56,03	35.408,75	436,25	8,21	1470	1,00
BOX HBF 112 T4 11kW (A3:8) F400 (°)	11	59,52	59,49	33.497,64	695,11	11,64	1470	1,00
BOX HBF 112 T4 11kW (A3:8) F400 (°)	11	59,41	59,44	30.195,59	708	10,66	1470	1,00
BOX HBF 112 T4 15kW (A3:8) F400 (°)	15	56,50	56,24	44.285,27	663,23	15,50	1465	1,00
BOX HBF 112 T4 15kW (A3:8) F400 (°)	15	57,78	57,60	40.666,11	670,97	14,07	1465	1,00
BOX HBF 112 T4 15kW (A3:8) F400 (°)	15	59,10	58,99	37.062,48	681,23	12,72	1465	1,00
BOX HBF 112 T4 18,5kW (A3:8) F400 (°)	18,5	53,40	52,98	51.076,20	674,33	18,96	1465	1,00
BOX HBF 112 T4 18,5kW (A3:8) F400 (°)	18,5	55,48	55,15	47.984,32	657,81	16,90	1465	1,00
BOX HBF 112 T4 22kW (A3:8) F400 (°)	22	49,77	49,20	57.042,61	699,22	23,14	1465	1,00
BOX HBF 112 T4 22kW (A3:8) F400 (°)	22	51,62	51,12	54.223,31	690,24	21,10	1465	1,00
BOX HBF 112 T4 30kW (A3:8) F400 (°)	30	46,45	45,76	62.509,16	704,62	27,06	1470	1,00
BOX HBF 112 T4 30kW (A3:8) F400 (°)	30	48,48	47,85	59.738,16	701,78	24,86	1470	1,00
BOX HBF 125 T4 11kW (A3:4) F400 (°)	11	58,21	58,24	38.867,01	544,20	10,72	1470	1,00
BOX HBF 125 T4 11kW (A3:4) F400 (°)	11	59,70	59,89	34.627,57	555,89	9,43	1470	1,00
BOX HBF 125 T4 15kW (A3:4) F400 (°)	15	54,41	54,17	52.641,94	533,79	15,06	1465	1,00
BOX HBF 125 T4 15kW (A3:4) F400 (°)	15	55,99	55,85	47.908,39	532,86	13,44	1465	1,00
BOX HBF 125 T4 15kW (A3:4) F400 (°)	15	57,13	57,08	43.235,32	536,37	12,01	1465	1,00
BOX HBF 125 T4 18,5kW (A3:4) F400 (°)	18,5	51,38	50,99	60.950,03	546,90	18,40	1465	1,00
BOX HBF 125 T4 18,5kW (A3:4) F400 (°)	18,5	53,14	52,83	57.616,06	538,43	16,65	1465	1,00
BOX HBF 125 T4 18,5kW (A3:8) F400 (°)	18,5	60,33	59,91	45.513,87	844,37	18,92	1465	1,00
BOX HBF 125 T4 18,5kW (A3:8) F400 (°)	18,5	60,17	59,82	40.816,50	865,45	17,39	1465	1,00
BOX HBF 125 T4 22kW (A3:4) F400 (°)	22	46,40	45,84	67.695,79	552,09	22,74	1465	1,00
BOX HBF 125 T4 22kW (A3:4) F400 (°)	22	49,42	48,94	64.631,14	554,34	20,49	1465	1,00
BOX HBF 125 T4 22kW (A3:8) F400 (°)	22	58,26	57,69	54.888,01	820,52	23,04	1465	1,00
BOX HBF 125 T4 22kW (A3:8) F400 (°)	22	59,65	59,16	50.101,18	832,37	20,84	1465	1,00
BOX HBF 125 T4 30kW (A3:8) F400 (°)	30	53,89	53,09	68.709,09	827,35	30,96	1470	1,00
BOX HBF 125 T4 30kW (A3:8) F400 (°)	30	55,98	55,28	64.842,17	805,03	27,60	1470	1,00

Model	Motor power (kW)	Maximum efficiency point data						
		Max. efficiency (%)	Efficiency grade (N) (N)	Air Flow (m3/h)	Ps (Pa)	Pabs (kW)	speed (rpm)	Specific ratio
BOX HBF 125 T4 30kW (A3:8) F400 (°)	30	57,49	56,85	59.887,35	810,69	25,16	1470	1,00
BOX HBF 125 T4 37kW (A3:8) F400 (°)	37	50,51	49,55	77.349,10	853,45	37,87	1475	1,00
BOX HBF 125 T4 37kW (A3:8) F400 (°)	37	52,01	51,13	73.025,87	843,98	34,43	1475	1,00
BOX HBF 125 T4 45kW (A3:8) F400 (°)	45	46,52	45,44	84.191,86	861,51	44,34	1475	1,00
BOX HBF 125 T4 45kW (A3:8) F400 (°)	45	48,98	47,97	80.875,45	856,90	40,79	1475	1,00

**ERP / 6 poles**

Model	Motor power (kW)	Maximum efficiency point data						
		Max. efficiency (%)	Efficiency grade (N) (N)	Air Flow (m3/h)	Ps (Pa)	Pabs (kW)	speed (rpm)	Specific ratio
BOX HBF 50 T6 0,75kW (A5:6) F400 (°)	0,75	26,51	37,89	3.801,51	49,14	0,16	923	1,00
BOX HBF 56 T6 0,75kW (A5:6) F400 (°)	0,55	30,33	38,94	5.459,45	84,52	0,44	923	1,00
BOX HBF 63 T6 0,75kW (A5:6) F400 (°)	0,55	34,06	41,69	7.615,85	94,49	0,62	923	1,00
BOX HBF 71 T6 0,75kW (A5:6) F400 (°)	0,75	30,27	36,76	9.801,75	101,01	0,94	923	1,00
BOX HBF 71 T6 0,75kW (A5:6) F400 (°)	0,75	31,83	38,57	9.342,20	101,35	0,86	923	1,00
BOX HBF 71 T6 0,75kW (A5:6) F400 (°)	0,75	33,76	40,76	8.892	102,10	0,78	923	1,00
BOX HBF 80 T6 0,75kW (A5:6) F400 (°)	0,75	46,42	53,13	10.781,95	130,20	0,87	923	1,00
BOX HBF 80 T6 1,1kW (A5:6) F400 (°)	1,1	45,75	52,11	11.564,61	135,49	0,99	920	1,00
BOX HBF 80 T6 1,1kW (A5:6) F400 (°)	1,1	45,38	51,44	12.346,06	140,98	1,11	920	1,00
BOX HBF 80 T6 1,5kW (A5:6) F400 (°)	1,5	43,39	49,15	13.270,90	139,67	1,23	933	1,00
BOX HBF 80 T6 1,5kW (A5:6) F400 (°)	1,5	42,03	47,52	14.230,04	138,45	1,36	933	1,00
BOX HBF 80 T6 2,2kW (A5:6) F400 (°)	2,2	35,88	40,81	15.634,47	132,64	1,67	948	1,00
BOX HBF 90 T6 1,5kW (A3:4) F400 (°)	1,5	44,99	51,97	9.583,78	124,98	0,79	940	1,00
BOX HBF 90 T6 1,5kW (A3:4) F400 (°)	1,5	42,25	48,02	12.493,84	142,68	1,23	940	1,00
BOX HBF 90 T6 1,5kW (A3:4) F400 (°)	1,5	43,62	49,78	11.508,58	137,15	1,06	940	1,00
BOX HBF 90 T6 1,5kW (A3:4) F400 (°)	1,5	44,95	51,55	10.556,97	131,26	0,91	940	1,00
BOX HBF 90 T6 1,5kW (A3:4) F400 (°)	1,5	39,16	44	15.175,88	153,82	1,73	940	1,00
BOX HBF 90 T6 1,5kW (A3:4) F400 (°)	1,5	40,51	45,57	14.458,45	154,42	1,59	940	1,00
BOX HBF 90 T6 1,5kW (A3:4) F400 (°)	1,5	41,76	47,18	13.448,72	148,79	1,39	940	1,00
BOX HBF 90 T6 1,5kW (A3:8) F400 (°)	1,5	43,13	47,88	12.501,64	197,85	1,78	940	1,00
BOX HBF 90 T6 1,5kW (A3:8) F400 (°)	1,5	44,11	49,24	11.328,69	193,42	1,55	940	1,00
BOX HBF 90 T6 1,5kW (A3:8) F400 (°)	1,5	44,93	50,45	10.229,46	188,94	1,34	940	1,00
BOX HBF 90 T6 2,2kW (A3:4) F400 (°)	2,2	32,98	36,88	18.362,87	149,62	2,43	940	1,00
BOX HBF 90 T6 2,2kW (A3:4) F400 (°)	2,2	34,92	39,08	17.489,63	151,36	2,20	940	1,00
BOX HBF 90 T6 2,2kW (A3:4) F400 (°)	2,2	36,98	41,41	16.731,31	152,65	2	940	1,00
BOX HBF 90 T6 2,2kW (A3:4) F400 (°)	2,2	38,76	43,43	15.956,21	153,67	1,83	940	1,00

Model	Motor power (kW)	Maximum efficiency point data						
		Max. efficiency (%)	Efficiency grade (N) (N)	Air Flow (m3/h)	Ps (Pa)	Pabs (kW)	speed (rpm)	Specific ratio
BOX HBF 90 T6 2,2kW (A3:8) F400 (°)	2,2	41,21	44,98	16.064,98	214,09	2,54	940	1,00
BOX HBF 90 T6 2,2kW (A3:8) F400 (°)	2,2	42,13	46,22	14.838,62	208,75	2,26	940	1,00
BOX HBF 90 T6 2,2kW (A3:8) F400 (°)	2,2	43,04	47,49	13.628,47	203,46	1,99	940	1,00
BOX HBF 90 T6 3kW (A3:8) F400 (°)	3	38,31	41,40	18.908,19	221,14	3,26	960	1,00
BOX HBF 90 T6 3kW (A3:8) F400 (°)	3	39,43	42,75	18.011,07	218,50	3	960	1,00
BOX HBF 90 T6 3kW (A3:8) F400 (°)	3	40,73	44,29	17.055,17	216,34	2,75	960	1,00
BOX HBF 90 T6 4kW (A3:8) F400 (°)	4	36,47	39,13	20.775,85	228	3,81	960	1,00
BOX HBF 90 T6 4kW (A3:8) F400 (°)	4	37,78	40,68	19.832,49	224,67	3,50	960	1,00
BOX HBF 100 T6 1,5kW (A3:4) F400 (°)	1,5	48	52,79	17.179,76	168,57	1,76	940	1,00
BOX HBF 100 T6 1,5kW (A3:4) F400 (°)	1,5	49,51	54,63	15.922,72	165,18	1,55	940	1,00
BOX HBF 100 T6 1,5kW (A3:4) F400 (°)	1,5	51,08	56,56	14.653,56	161,73	1,36	940	1,00
BOX HBF 100 T6 1,5kW (A3:4) F400 (°)	1,5	51,69	57,48	13.485,58	158,21	1,22	940	1,00
BOX HBF 100 T6 2,2kW (A3:4) F400 (°)	1,5	48	52,79	17.179,76	168,57	1,76	940	1,00
BOX HBF 100 T6 2,2kW (A3:4) F400 (°)	1,5	49,51	54,63	15.922,72	165,18	1,55	940	1,00
BOX HBF 100 T6 2,2kW (A3:4) F400 (°)	1,5	51,08	56,56	14.653,56	161,73	1,36	940	1,00
BOX HBF 100 T6 2,2kW (A3:4) F400 (°)	1,5	51,69	57,48	13.485,58	158,21	1,22	940	1,00
BOX HBF 100 T6 2,2kW (A3:4) F400 (°)	2,2	44,23	48,15	20.995,57	176,96	2,42	940	1,00
BOX HBF 100 T6 2,2kW (A3:4) F400 (°)	2,2	45,96	50,16	19.862,23	174,86	2,18	940	1,00
BOX HBF 100 T6 2,2kW (A3:4) F400 (°)	2,2	47,55	52,06	18.545,55	171,45	1,94	940	1,00
BOX HBF 100 T6 2,2kW (A3:8) F400 (°)	2,2	51,21	55,01	16.476,91	256,68	2,51	940	1,00
BOX HBF 100 T6 2,2kW (A3:8) F400 (°)	2,2	51,92	55,99	15.169,13	255,11	2,28	940	1,00
BOX HBF 100 T6 3kW (A3:4) F400 (°)	3	38,98	42,10	24.548,30	178	3,23	960	1,00
BOX HBF 100 T6 3kW (A3:4) F400 (°)	3	41,08	44,48	23.289,51	179,45	2,92	960	1,00
BOX HBF 100 T6 3kW (A3:4) F400 (°)	3	43,18	46,85	22.123,26	179,46	2,64	960	1,00
BOX HBF 100 T6 3kW (A3:8) F400 (°)	3	47,99	51,02	20.468,71	259,15	3,34	960	1,00
BOX HBF 100 T6 3kW (A3:8) F400 (°)	3	49,37	52,67	19.128,02	258,39	3,03	960	1,00
BOX HBF 100 T6 3kW (A3:8) F400 (°)	3	50,84	54,42	17.792,04	257,31	2,74	960	1,00
BOX HBF 100 T6 4kW (A3:4) F400 (°)	4	37,30	40,18	25.772,81	176,56	3,52	960	1,00
BOX HBF 100 T6 4kW (A3:8) F400 (°)	4	44,50	46,75	24.680,80	269,11	4,44	960	1,00
BOX HBF 100 T6 4kW (A3:8) F400 (°)	4	45,88	48,41	23.240,09	265,30	4,01	960	1,00
BOX HBF 100 T6 4kW (A3:8) F400 (°)	4	47,24	50,05	21.823,06	259,99	3,61	960	1,00
BOX HBF 100 T6 5,5kW (A3:8) F400 (°)	5,5	40,35	41,83	29.503,31	278,58	5,88	960	1,00
BOX HBF 100 T6 5,5kW (A3:8) F400 (°)	5,5	41,89	43,63	27.803,89	275,54	5,34	960	1,00
BOX HBF 100 T6 5,5kW (A3:8) F400 (°)	5,5	43,47	45,48	26.154,22	273,04	4,85	960	1,00
BOX HBF 112 T6 2,2kW (A3:4) F400 (°)	2,2	51,44	55,36	22.980,29	183,02	2,41	940	1,00
BOX HBF 112 T6 2,2kW (A3:4) F400 (°)	2,2	52,53	56,76	20.748,94	183,87	2,15	940	1,00
BOX HBF 112 T6 2,2kW (A3:4) F400 (°)	2,2	53,88	58,45	18.574,72	187,51	1,91	940	1,00
BOX HBF 112 T6 2,2kW (A3:4) F400 (°)	2,2	54,23	59,09	16.623,41	190,80	1,71	940	1,00

Model	Motor power (kW)	Maximum efficiency point data						
		Max. efficiency (%)	Efficiency grade (N) (N)	Air Flow (m3/h)	Ps (Pa)	Pabs (kW)	speed (rpm)	Specific ratio
BOX HBF 112 T6 3kW (A3:4) F400 (°)	3	47,73	50,82	29.265,33	187,47	3,26	960	1,00
BOX HBF 112 T6 3kW (A3:4) F400 (°)	3	49,40	52,76	27.623,78	184,84	2,95	960	1,00
BOX HBF 112 T6 3kW (A3:4) F400 (°)	3	50,81	54,47	25.245,67	183,08	2,66	960	1,00
BOX HBF 112 T6 3kW (A3:8) F400 (°)	3	56	59,01	21.778,10	290,64	3,36	960	1,00
BOX HBF 112 T6 3kW (A3:8) F400 (°)	3	55,92	59,16	19.608,60	296,90	3,08	960	1,00
BOX HBF 112 T6 4kW (A3:8) F400 (°)	4	53,43	55,66	28.677,77	278,34	4,46	960	1,00
BOX HBF 112 T6 4kW (A3:8) F400 (°)	4	54,62	57,12	26.316,98	281,58	4,05	960	1,00
BOX HBF 112 T6 4kW (A3:8) F400 (°)	4	55,86	58,64	24.040,42	285,48	3,66	960	1,00
BOX HBF 112 T6 5,5kW (A3:8) F400 (°)	5,5	49,03	50,43	35.104,47	289,64	6,04	960	1,00
BOX HBF 112 T6 5,5kW (A3:8) F400 (°)	5,5	50,96	52,67	33.100,89	283,06	5,40	960	1,00
BOX HBF 112 T6 5,5kW (A3:8) F400 (°)	5,5	52,93	54,95	31.076,68	276,36	4,82	960	1,00
BOX HBF 112 T6 7,5kW (A3:8) F400 (°)	7,5	44,41	45,14	40.492,81	295,56	7,70	970	1,00
BOX HBF 112 T6 7,5kW (A3:8) F400 (°)	7,5	46,28	47,24	38.694,32	294,24	7,08	970	1,00
BOX HBF 112 T6 7,5kW (A3:8) F400 (°)	7,5	47,84	49,02	36.964,24	293,63	6,55	970	1,00
BOX HBF 125 T6 3kW (A3:4) F400 (°)	3	53,40	56,30	28.018,57	225,20	3,50	960	1,00
BOX HBF 125 T6 3kW (A3:4) F400 (°)	3	54,75	57,98	25.151,44	228,34	3,10	960	1,00
BOX HBF 125 T6 3kW (A3:4) F400 (°)	3	56,19	59,78	22.380,14	234,07	2,72	960	1,00
BOX HBF 125 T6 4kW (A3:4) F400 (°)	4	51,57	53,88	34.126,02	224,01	4,32	960	1,00
BOX HBF 125 T6 4kW (A3:4) F400 (°)	4	52,93	55,56	31.002,15	223,93	3,87	960	1,00
BOX HBF 125 T6 5,5kW (A3:4) F400 (°)	5,5	46,86	48,34	41.817,50	232,85	5,87	960	1,00
BOX HBF 125 T6 5,5kW (A3:4) F400 (°)	5,5	49,08	50,87	39.514,98	229,55	5,24	960	1,00
BOX HBF 125 T6 5,5kW (A3:4) F400 (°)	5,5	50,80	52,87	37.300,23	226,18	4,74	960	1,00
BOX HBF 125 T6 5,5kW (A3:8) F400 (°)	5,5	56,65	58,09	32.472,13	349,36	5,96	960	1,00
BOX HBF 125 T6 5,5kW (A3:8) F400 (°)	5,5	57,62	59,33	29.427,43	355,11	5,39	960	1,00
BOX HBF 125 T6 5,5kW (A3:8) F400 (°)	5,5	57,44	59,39	26.471,98	362,86	4,95	960	1,00
BOX HBF 125 T6 7,5kW (A3:8) F400 (°)	7,5	53,64	54,32	42.032,28	337,28	7,86	970	1,00
BOX HBF 125 T6 7,5kW (A3:8) F400 (°)	7,5	54,83	55,77	38.760,28	340,40	7,17	970	1,00
BOX HBF 125 T6 7,5kW (A3:8) F400 (°)	7,5	56,09	57,28	35.571,49	344,23	6,51	970	1,00
BOX HBF 125 T6 11kW (A3:8) F400 (°)	11	46,87	46,84	52.275,06	360,26	11,53	970	1,00
BOX HBF 125 T6 11kW (A3:8) F400 (°)	11	48,44	48,48	49.919,01	358,48	10,67	970	1,00
BOX HBF 125 T6 11kW (A3:8) F400 (°)	11	50,25	50,35	47.408,37	353,84	9,71	970	1,00
BOX HBF 125 T6 11kW (A3:8) F400 (°)	11	52,34	52,75	44.711,09	346,17	8,69	970	1,00
BOX HBF 125 T6 15kW (A3:8) F400 (°)	15	45,55	45,47	54.803,88	361,22	12,43	970	1,00

**ERP / 4/8 poles**

Model	Motor power (kW)	Maximum efficiency point data						
		Max. efficiency (%)	Efficiency grade (N) (N)	Air Flow (m3/h)	Ps (Pa)	Pabs (kW)	speed (rpm)	Specific ratio
BOX HBF 45 T4/T8 0,8/0,2kW (A5:6) F400 (°)	0,8/0,2	25,22	34,25	3.938,40	91,48	0,37	1500	1,00
BOX HBF 50 T4/T8 0,8/0,2kW (A5:6) F400 (°)	0,8/0,2	33,75	41,93	5.631,13	108,38	0,51	1500	1,00
BOX HBF 56 T4/T8 0,8/0,2kW (A5:6) F400 (°)	0,8/0,2	38,49	46,08	5.286,46	156,65	0,63	1500	1,00
BOX HBF 56 T4/T8 0,8/0,2kW (A5:6) F400 (°)	0,8/0,2	38,91	45,71	6.799,71	163,76	0,84	1500	1,00
BOX HBF 56 T4/T8 0,8/0,2kW (A5:6) F400 (°)	0,8/0,2	40,36	47,48	6.377,29	162,70	0,75	1500	1,00
BOX HBF 56 T4/T8 1,2/0,3kW (A5:6) F400 (°)	1,2/0,3	35,94	41,99	7.864,11	175,27	1,11	1500	1,00
BOX HBF 56 T4/T8 1,2/0,3kW (A5:6) F400 (°)	1,2/0,3	37,33	43,85	7.198,19	163,79	0,93	1500	1,00
BOX HBF 56 T4/T8 1,6/0,4kW (A5:6) F400 (°)	1,6/0,4	35,35	41	8.575,19	185,04	1,28	1500	1,00
BOX HBF 56 T4/T8 1,6/0,4kW (A5:6) F400 (°)	1,6/0,4	35,43	40,72	9.299,95	193,09	1,46	1500	1,00
BOX HBF 63 T4/T8 0,8/0,2kW (A5:6) F400 (°)	0,8/0,2	46,63	53,25	7.384,78	192,08	0,90	1500	1,00
BOX HBF 63 T4/T8 1,2/0,3kW (A5:6) F400 (°)	1,2/0,3	46,52	52,17	9.056,31	221,36	1,28	1500	1,00
BOX HBF 63 T4/T8 1,6/0,4kW (A5:6) F400 (°)	1,6/0,4	42,12	47,20	10.066,20	229,21	1,58	1500	1,00
BOX HBF 63 T4/T8 1,6/0,4kW (A5:6) F400 (°)	1,6/0,4	44,39	49,74	9.588,71	224,77	1,43	1500	1,00
BOX HBF 63 T4/T8 2,2/0,37kW (A5:6) F400 (°)	2,2 / 0,37	40,03	44,74	10.830,65	229,31	1,81	1500	1,00
BOX HBF 63 T4/T8 2,2/0,37kW (A5:6) F400 (°)	2,2 / 0,37	38,35	42,73	11.588,88	230,37	2,03	1500	1,00
BOX HBF 71 T4/T8 0,8/0,2kW (A5:6) F400 (°)	0,8/0,2	47,01	53,39	7.908,74	201,69	0,98	1500	1,00
BOX HBF 71 T4/T8 1,2/0,3kW (A5:6) F400 (°)	1,2/0,3	45,67	51,11	9.865,86	221,15	1,39	1500	1,00
BOX HBF 71 T4/T8 1,6/0,4kW (A5:6) F400 (°)	1,6/0,4	46,22	50,95	11.855,32	240,58	1,80	1500	1,00
BOX HBF 71 T4/T8 2,2/0,37kW (A5:6) F400 (°)	2,2 / 0,37	42,32	46,19	14.007,05	256,86	2,46	1500	1,00
BOX HBF 71 T4/T8 2,2/0,37kW (A5:6) F400 (°)	2,2 / 0,37	43,85	48,11	12.922	248,26	2,13	1500	1,00
BOX HBF 71 T4/T8 3/0,55kW (A5:6) F400 (°)	3 / 0,55	39,37	42,79	15.295,05	255,96	2,89	1500	1,00
BOX HBF 71 T4/T8 3/0,55kW (A5:6) F400 (°)	3 / 0,55	40,72	44,36	14.637,66	255,51	2,67	1500	1,00
BOX HBF 80 T4/T8 3/0,55kW (A5:6) F400 (°)	3 / 0,55	47,47	50,44	18.603,39	298,09	3,41	1500	1,00
BOX HBF 80 T4/T8 3/0,55kW (A5:6) F400 (°)	3 / 0,55	49,89	53,19	17.421,07	297,07	3,02	1500	1,00
BOX HBF 80 T4/T8 3/0,55kW (A5:6) F400 (°)	3 / 0,55	53,27	56,95	16.269,95	295,38	2,63	1500	1,00
BOX HBF 80 T4/T8 4/0,75kW (A5:6) F400 (°)	4 / 0,75	46,01	48,67	20.008,80	305,30	3,81	1500	1,00
BOX HBF 80 T4/T8 4/0,75kW (A5:6) F400 (°)	4 / 0,75	45,44	47,83	21.569,23	310,17	4,22	1500	1,00
BOX HBF 90 T4/T8 2,8/0,7kW (A3:4) F400 (°)	2,8/0,7	48,40	51,64	16.269,79	312,06	3,09	1420	1,00
BOX HBF 90 T4/T8 2,8/0,7kW (A3:4) F400 (°)	2,8/0,7	49,88	53,58	14.806,82	298,15	2,61	1420	1,00
BOX HBF 90 T4/T8 4/0,75kW (A3:4) F400 (°)	4/0,75	46,06	48,49	19.259,13	340,14	4,15	1420	1,00
BOX HBF 90 T4/T8 4/0,75kW (A3:4) F400 (°)	4/0,75	47,50	50,34	17.768,06	326,89	3,58	1420	1,00
BOX HBF 90 T4/T8 5,5/1,1kW (A3:4) F400 (°)	5,5/1,1	42,44	43,93	23.455,15	367,14	5,86	1420	1,00
BOX HBF 90 T4/T8 5,5/1,1kW (A3:4) F400 (°)	5,5/1,1	43,92	45,63	22.345,93	367,81	5,41	1420	1,00
BOX HBF 90 T4/T8 5,5/1,1kW (A3:4) F400 (°)	5,5/1,1	45,22	47,29	20.822,29	353,92	4,73	1420	1,00
BOX HBF 90 T4/T8 5,5/1,1kW (A3:8) F400 (°)	5,5/1,1	47,68	49,45	17.497,66	461,40	5,27	1420	1,00
BOX HBF 90 T4/T8 5,5/1,1kW (A3:8) F400 (°)	5,5/1,1	48,67	50,84	15.786,74	450,04	4,57	1420	1,00
BOX HBF 90 T4/T8 7,5/1,5kW (A3:4) F400 (°)	7,5/1,5	37,31	38,09	27.009,72	360,41	7,58	1420	1,00
BOX HBF 90 T4/T8 7,5/1,5kW (A3:4) F400 (°)	7,5/1,5	39,50	40,55	25.787,41	364,05	6,88	1420	1,00
BOX HBF 90 T4/T8 7,5/1,5kW (A3:4) F400 (°)	7,5/1,5	41,38	42,67	24.607,17	366,35	6,30	1420	1,00



Model	Motor power (kW)	Maximum efficiency point data						
		Max. efficiency (%)	Efficiency grade (N) (N)	Air Flow (m3/h)	Ps (Pa)	Pabs (kW)	speed (rpm)	Specific ratio
BOX HBF 90 T4/T8 7,5/1,5kW (A3:4) F400 (°)	7,5/1,5	42,44	43,93	23.455,15	367,14	5,86	1420	1,00
BOX HBF 90 T4/T8 7,5/1,5kW (A3:8) F400 (°)	7,5/1,5	45,05	45,76	22.907,92	496,52	7,76	1420	1,00
BOX HBF 90 T4/T8 7,5/1,5kW (A3:8) F400 (°)	7,5/1,5	46,06	47,13	21.070,55	483,55	6,84	1420	1,00
BOX HBF 90 T4/T8 7,5/1,5kW (A3:8) F400 (°)	7,5/1,5	46,56	47,96	19.242,52	472,46	6,05	1420	1,00
BOX HBF 90 T4/T8 11/3kW (A3:4) F400 (°)	11/3	35,47	36,01	28.252,71	356,23	8,28	1420	1,00
BOX HBF 90 T4/T8 11/3kW (A3:8) F400 (°)	11/3	40,70	40,69	29.199,51	527,28	11,30	1420	1,00
BOX HBF 90 T4/T8 11/3kW (A3:8) F400 (°)	11/3	41,82	41,88	27.753,29	520,19	10,39	1420	1,00
BOX HBF 90 T4/T8 11/3kW (A3:8) F400 (°)	11/3	43,24	43,40	26.309,90	515,21	9,50	1420	1,00
BOX HBF 90 T4/T8 11/3kW (A3:8) F400 (°)	11/3	44,52	44,93	24.798,94	510,53	8,67	1420	1,00
BOX HBF 90 T4/T8 14/3,5kW (A3:8) F400 (°)	14/3,5	38,50	38,36	32.064,08	543,37	13,28	1420	1,00
BOX HBF 90 T4/T8 14/3,5kW (A3:8) F400 (°)	14/3,5	39,99	39,92	30.693,75	535,39	12,16	1420	1,00
BOX HBF 100 T4/T8 5,5/1,1kW (A3:4) F400 (°)	5,5/1,1	51,87	53,30	26.551,96	401	5,98	1420	1,00
BOX HBF 100 T4/T8 5,5/1,1kW (A3:4) F400 (°)	5,5/1,1	53,50	55,28	24.581,71	393,08	5,28	1420	1,00
BOX HBF 100 T4/T8 5,5/1,1kW (A3:4) F400 (°)	5,5/1,1	55,29	57,42	22.619,79	386,25	4,64	1420	1,00
BOX HBF 100 T4/T8 5,5/1,1kW (A3:4) F400 (°)	5,5/1,1	56,41	58,86	20.842,55	377,22	4,11	1420	1,00
BOX HBF 100 T4/T8 7,5/1,5kW (A3:4) F400 (°)	7,5/1,5	49,06	49,88	30.676,32	415,55	7,49	1420	1,00
BOX HBF 100 T4/T8 7,5/1,5kW (A3:4) F400 (°)	7,5/1,5	50,77	51,90	28.592,36	409,27	6,67	1420	1,00
BOX HBF 100 T4/T8 7,5/1,5kW (A3:8) F400 (°)	7,5/1,5	55,47	56,16	23.417,68	607,83	7,82	1420	1,00
BOX HBF 100 T4/T8 11/3kW (A3:4) F400 (°)	11/3	41,52	41,52	37.883,88	424,19	11,15	1420	1,00
BOX HBF 100 T4/T8 11/3kW (A3:4) F400 (°)	11/3	43,81	43,89	35.974,38	428,43	10,10	1420	1,00
BOX HBF 100 T4/T8 11/3kW (A3:4) F400 (°)	11/3	45,92	46,20	34.144,20	427,62	9,11	1420	1,00
BOX HBF 100 T4/T8 11/3kW (A3:4) F400 (°)	11/3	47,76	48,32	32.382,92	421,97	8,22	1420	1,00
BOX HBF 100 T4/T8 11/3kW (A3:8) F400 (°)	11/3	51,03	51,01	31.641,86	617,34	11,55	1420	1,00
BOX HBF 100 T4/T8 11/3kW (A3:8) F400 (°)	11/3	52,54	52,58	29.528,86	615,77	10,48	1420	1,00
BOX HBF 100 T4/T8 11/3kW (A3:8) F400 (°)	11/3	53,94	54,11	27.456,87	612,59	9,47	1420	1,00
BOX HBF 100 T4/T8 11/3kW (A3:8) F400 (°)	11/3	55,20	55,65	25.420,36	610,20	8,56	1420	1,00
BOX HBF 100 T4/T8 14/3,5kW (A3:4) F400 (°)	14/3,5	39,45	39,38	39.773,65	420,72	12,24	1420	1,00
BOX HBF 100 T4/T8 14/3,5kW (A3:8) F400 (°)	14/3,5	48,58	48,41	35.858,39	631,14	13,92	1420	1,00
BOX HBF 100 T4/T8 14/3,5kW (A3:8) F400 (°)	14/3,5	50,05	49,95	33.667,23	620,57	12,57	1420	1,00
BOX HBF 100 T4/T8 17/4,3kW (A3:8) F400 (°)	17/4,3	45,47	45,14	40.435,64	650,15	17,04	1420	1,00
BOX HBF 100 T4/T8 17/4,3kW (A3:8) F400 (°)	17/4,3	47,09	46,83	38.099,12	641,83	15,45	1420	1,00
BOX HBF 100 T4/T8 20/5kW (A3:8) F400 (°)	20/5	42,42	41,94	45.506,86	663,64	20,54	1420	1,00
BOX HBF 100 T4/T8 20/5kW (A3:8) F400 (°)	20/5	43,92	43,51	42.881,99	657,50	18,71	1420	1,00
BOX HBF 112 T4/T8 5,5/1,1kW (A3:4) F400 (°)	5,5/1,1	58,57	60,07	25.650,99	454,24	5,82	1420	1,00
BOX HBF 112 T4/T8 7,5/1,5kW (A3:4) F400 (°)	7,5/1,5	56,18	57,03	31.958,45	439,65	7,40	1420	1,00
BOX HBF 112 T4/T8 7,5/1,5kW (A3:4) F400 (°)	7,5/1,5	57,62	58,79	28.722,21	445,68	6,56	1420	1,00
BOX HBF 112 T4/T8 11/3kW (A3:4) F400 (°)	11/3	50,77	50,76	45.167,47	447,36	11,30	1420	1,00
BOX HBF 112 T4/T8 11/3kW (A3:4) F400 (°)	11/3	52,52	52,59	42.650,78	440,51	10,20	1420	1,00



Model	Motor power (kW)	Maximum efficiency point data						
		Max. efficiency (%)	Efficiency grade (N) (N)	Air Flow (m3/h)	Ps (Pa)	Pabs (kW)	speed (rpm)	Specific ratio
BOX HBF 112 T4/T8 11/3kW (A3:4) F400 (°)	11/3	54,03	54,29	38.950,75	437	9,18	1420	1,00
BOX HBF 112 T4/T8 11/3kW (A3:4) F400 (°)	11/3	55,47	56,03	35.408,75	436,25	8,21	1420	1,00
BOX HBF 112 T4/T8 11/3kW (A3:8) F400 (°)	11/3	59,41	59,44	30.195,59	708	10,66	1420	1,00
BOX HBF 112 T4/T8 14/3,5kW (A3:4) F400 (°)	14/3,5	46,10	45,93	50.091,11	451,84	13,88	1420	1,00
BOX HBF 112 T4/T8 14/3,5kW (A3:4) F400 (°)	14/3,5	48,91	48,82	47.787,36	454,15	12,54	1420	1,00
BOX HBF 112 T4/T8 14/3,5kW (A3:8) F400 (°)	14/3,5	57,78	57,60	40.666,11	670,97	14,07	1420	1,00
BOX HBF 112 T4/T8 14/3,5kW (A3:8) F400 (°)	14/3,5	59,10	58,99	37.062,48	681,23	12,72	1420	1,00
BOX HBF 112 T4/T8 14/3,5kW (A3:8) F400 (°)	14/3,5	59,52	59,49	33.497,64	695,11	11,64	1420	1,00
BOX HBF 112 T4/T8 17/4,3kW (A3:8) F400 (°)	17/4,3	55,48	55,15	47.984,32	657,81	16,90	1420	1,00
BOX HBF 112 T4/T8 17/4,3kW (A3:8) F400 (°)	17/4,3	56,50	56,24	44.285,27	663,23	15,50	1420	1,00
BOX HBF 112 T4/T8 20/5kW (A3:8) F400 (°)	20/5	53,40	52,98	51.076,20	674,33	18,96	1420	1,00
BOX HBF 112 T4/T8 28/6,5kW (A3:8) F400 (°)	28/6,5	46,45	45,76	62.509,16	704,62	27,06	1420	1,00
BOX HBF 112 T4/T8 28/6,5kW (A3:8) F400 (°)	28/6,5	48,48	47,85	59.738,16	701,78	24,86	1420	1,00
BOX HBF 112 T4/T8 28/6,5kW (A3:8) F400 (°)	28/6,5	49,77	49,20	57.042,61	699,22	23,14	1420	1,00
BOX HBF 112 T4/T8 28/6,5kW (A3:8) F400 (°)	28/6,5	51,62	51,12	54.223,31	690,24	21,10	1420	1,00
BOX HBF 125 T4/T8 11/3kW (A3:4) F400 (°)	11/3	58,21	58,24	38.867,01	544,20	10,72	1420	1,00
BOX HBF 125 T4/T8 11/3kW (A3:4) F400 (°)	11/3	59,70	59,89	34.627,57	555,89	9,43	1420	1,00
BOX HBF 125 T4/T8 14/3,5kW (A3:4) F400 (°)	14/3,5	55,99	55,85	47.908,39	532,86	13,44	1420	1,00
BOX HBF 125 T4/T8 14/3,5kW (A3:4) F400 (°)	14/3,5	57,13	57,08	43.235,32	536,37	12,01	1420	1,00
BOX HBF 125 T4/T8 17/4,3kW (A3:4) F400 (°)	17/4,3	53,14	52,83	57.616,06	538,43	16,65	1420	1,00
BOX HBF 125 T4/T8 17/4,3kW (A3:4) F400 (°)	17/4,3	54,41	54,17	52.641,94	533,79	15,06	1420	1,00
BOX HBF 125 T4/T8 20/5kW (A3:4) F400 (°)	20/5	49,42	48,94	64.631,14	554,34	20,49	1420	1,00
BOX HBF 125 T4/T8 20/5kW (A3:4) F400 (°)	20/5	51,38	50,99	60.950,03	546,90	18,40	1420	1,00
BOX HBF 125 T4/T8 20/5kW (A3:8) F400 (°)	20/5	59,65	59,16	50.101,18	832,37	20,84	1420	1,00
BOX HBF 125 T4/T8 20/5kW (A3:8) F400 (°)	20/5	60,33	59,91	45.513,87	844,37	18,92	1420	1,00
BOX HBF 125 T4/T8 20/5kW (A3:8) F400 (°)	20/5	60,17	59,82	40.816,50	865,45	17,39	1420	1,00
BOX HBF 125 T4/T8 28/6,5kW (A3:8) F400 (°)	28/6,5	55,98	55,28	64.842,17	805,03	27,60	1420	1,00
BOX HBF 125 T4/T8 28/6,5kW (A3:8) F400 (°)	28/6,5	57,49	56,85	59.887,35	810,69	25,16	1420	1,00
BOX HBF 125 T4/T8 28/6,5kW (A3:8) F400 (°)	28/6,5	58,26	57,69	54.888,01	820,52	23,04	1420	1,00
BOX HBF 125 T4/T8 37/9,2kW (A3:8) F400 (°)	37/9,2	50,51	49,55	77.349,10	853,45	37,87	1420	1,00
BOX HBF 125 T4/T8 37/9,2kW (A3:8) F400 (°)	37/9,2	52,01	51,13	73.025,87	843,98	34,43	1420	1,00
BOX HBF 125 T4/T8 37/9,2kW (A3:8) F400 (°)	37/9,2	53,89	53,09	68.709,09	827,35	30,96	1420	1,00
BOX HBF 125 T4/T8 44/11kW (A3:8) F400 (°)	44/11	46,52	45,44	84.191,86	861,51	44,34	1420	1,00
BOX HBF 125 T4/T8 44/11kW (A3:8) F400 (°)	44/11	48,98	47,97	80.875,45	856,90	40,79	1420	1,00