

HMF F400



LONG CASED AXIAL FAN 400°C/2H

MANUFACTURING FEATURES:

- Long cased axial fan with reinforced body.
- Modular motor-impeller assembly. Cast aluminium impeller with variable pitch angle. Epoxy powder finishing coat.
- Housing with motor access door for easy connection.
- Standard asynchronous squirrel-cage motor with IP-55 protection and Class H insulation certified 400°C/2h. Manufactured with standard voltages: 230/400V 50Hz in three phase motors up to 3kW and 400/690V 50Hz for higher powers.

APPLICATIONS:

Designed for inline installation, they are suitable for:

- Smoke emergency exhaust with motor inside the hazardous area.
- Maximum working temperature: 60°C.

UNDER REQUEST:

- Supply impeller (air direction from impeller to motor).
- 100% reversible impeller.

Official homologation by the European laboratory APPLUS according to EN 12101-3:2002, EN 12101-3:2002/AC:2005
 Certification Nr: 0370-CPR-0912

Accessories



Technical data

Three-phase motor / 4 poles

Code	Model	R.P.M.	Rated I. (A) 400V	Rated power kW	Max. Airflow m3/h	Sound db (A)*	Weight	Connect. diagram
26147606__AF	HMF 45 T4 0,75kW (A5:6) F400	1404	1,95	0,75	6.650	50	28	1
26150606__AF	HMF 50 T4 0,75kW (A5:6) F400	1404	1,95	0,75	8.760	52	38	1
26158656__AF	HMF 56 T4 0,75kW (A5:6) F400	1404	1,95	0,75	10.270	57	72	1
26160656__AF	HMF 56 T4 1,1kW (A5:6) F400	1392	2,7	1,10	11.890	56	77	1
26161656__AF	HMF 56 T4 1,5kW (A5:6) F400	1410	3,6	1,50	13.870	57	78	1
26165656__AF	HMF 63 T4 0,75kW (A5:6) F400	1404	1,95	0,75	11.420	60	74	1
26166656__AF	HMF 63 T4 1,1kW (A5:6) F400	1392	2,7	1,10	14.010	61	79	1
26167656__AF	HMF 63 T4 1,5kW (A5:6) F400	1410	3,6	1,50	15.780	57	80	1
26168656__AF	HMF 63 T4 2,2kW (A5:6) F400	1420	4,55	2,20	17.690	58	86	1
26172656__AF	HMF 71 T4 0,75kW (A5:6) F400	1404	1,95	0,75	12.950	65	91	1
26173656__AF	HMF 71 T4 1,1kW (A5:6) F400	1392	2,7	1,10	15.960	64	93	1
26174656__AF	HMF 71 T4 1,5kW (A5:6) F400	1410	3,6	1,50	18.960	63	94	1
26175656__AF	HMF 71 T4 2,2kW (A5:6) F400	1420	4,55	2,20	22.040	61	96	1
26176656__AF	HMF 71 T4 3kW (A5:6) F400	1420	6,12	3	23.900	63	99	1
26184656__AF	HMF 80 T4 3kW (A5:6) F400	1420	6,12	3	29.250	63	110	1
26185656__AF	HMF 80 T4 4kW (A5:6) F400	1428	8,57	4	32.300	64	123	1
26193634__AF	HMF 90 T4 3kW (A3:4) F400	1420	6,12	3	27.600	66	124	1
26194634__AF	HMF 90 T4 4kW (A3:4) F400	1428	8,57	4	32.700	65	137	1
26195634__AF	HMF 90 T4 5,5kW (A3:4) F400	1450	10,5	5,50	39.500	63	150	1
26195638__AF	HMF 90 T4 5,5kW (A3:8) F400	1450	10,5	5,50	32.000	70	154	1
26196634__AF	HMF 90 T4 7,5kW (A3:4) F400	1453	14,1	7,50	44.600	63	164	1
26196638__AF	HMF 90 T4 7,5kW (A3:8) F400	1453	14,1	7,50	37.100	68	168	1
26197634__AF	HMF 90 T4 11kW (A3:4) F400	1470	21,2	11	46.300	65	194	1
26197638__AF	HMF 90 T4 11kW (A3:8) F400	1470	21,2	11	47.600	66	195	1
26198638__AF	HMF 90 T4 15kW (A3:8) F400	1465	28,7	15	52.600	66	223	1
26114634__AF	HMF 100 T4 5,5kW (A3:4) F400	1450	10,5	5,50	45.600	71	163	1
26115634__AF	HMF 100 T4 7,5kW (A3:4) F400	1453	14,1	7,50	51.400	71	177	1
26115638__AF	HMF 100 T4 7,5kW (A3:8) F400	1453	14,1	7,50	39.400	81	180	1
26116634__AF	HMF 100 T4 11kW (A3:4) F400	1470	21,2	11	62.300	70	204	1
26116638__AF	HMF 100 T4 11kW (A3:8) F400	1470	21,2	11	52.500	76	207	1
26117634__AF	HMF 100 T4 15kW (A3:4) F400	1465	28,7	15	65.200	71	232	1
26117638__AF	HMF 100 T4 15kW (A3:8) F400	1465	28,7	15	63.600	73	235	1
26118638__AF	HMF 100 T4 18,5kW (A3:8) F400	1465	35,1	18,50	71.300	73	283	1
26119638__AF	HMF 100 T4 22kW (A3:8) F400	1465	40,5	22	75.100	74	284	1
26123634__AF	HMF 112 T4 5,5kW (A3:4) F400	1450	10,5	5,50	50.600	75	172	1

Code	Model	R.P.M.	Rated I. (A) 400V	Rated power kW	Max. Airflow m3/h	Sound db (A)*	Weight	Connect. diagram
26124634__AF	HMF 112 T4 7,5kW (A3:4) F400	1453	14,1	7,50	59.100	75	206	1
26125634__AF	HMF 112 T4 11kW (A3:4) F400	1470	21,2	11	75.500	72	230	1
26125638__AF	HMF 112 T4 11kW (A3:8) F400	1470	21,2	11	57.600	81	233	1
26126634__AF	HMF 112 T4 15kW (A3:4) F400	1465	28,7	15	86.200	72	255	1
26126638__AF	HMF 112 T4 15kW (A3:8) F400	1465	28,7	15	72.400	79	259	1
26127634__AF	HMF 112 T4 18,5kW (A3:4) F400	1465	35,1	18,50	89.500	73	298	1
26127638__AF	HMF 112 T4 18,5kW (A3:8) F400	1465	35,1	18,50	82.400	77	302	1
26128638__AF	HMF 112 T4 22kW (A3:8) F400	1465	40,5	22	91.800	75	303	1
26129638__AF	HMF 112 T4 30kW (A3:8) F400	1470	56,2	30	99.700	75	357	1
27106634__AF	HMF 125 T4 11kW (A3:4) F400	1470	21,2	11	74.100	83	254	1
27107634__AF	HMF 125 T4 15kW (A3:4) F400	1465	28,7	15	91.200	78	282	1
27108634__AF	HMF 125 T4 18,5kW (A3:4) F400	1465	35,1	18,50	102.000	76	330	1
27108638__AF	HMF 125 T4 18,5kW (A3:8) F400	1465	35,1	18,50	77.800	88	338	1
27109634__AF	HMF 125 T4 22kW (A3:4) F400	1465	40,5	22	112.000	75	331	1
27109638__AF	HMF 125 T4 22kW (A3:8) F400	1465	40,5	22	91.200	85	339	1
27110634__AF	HMF 125 T4 30kW (A3:4) F400	1470	56,2	30	121.000	75	391	1
27110638__AF	HMF 125 T4 30kW (A3:8) F400	1470	56,2	30	111.000	81	399	1
27111638__AF	HMF 125 T4 37kW (A3:8) F400	1475	66,6	37	124.000	78	500	1
27112638__AF	HMF 125 T4 45kW (A3:8) F400	1475	80,7	45	135.000	77	545	1

Three-phase motor / 6 poles

Code	Model	R.P.M.	Rated I. (A) 400V	Rated power kW	Max. Airflow m3/h	Sound db (A)*	Weight	Connect. diagram
26151606__AF	HMF 50 T6 0,75kW (A5:6) F400	923	2,2	0,75	6.000	43	35	1
26158656__AF	HMF 56 T6 0,75kW (A5:6) F400	923	2,2	0,75	8.330	48	71	1
26164656__AF	HMF 63 T6 0,75kW (A5:6) F400	923	2,2	0,75	11.450	50	72	1
26172656__AF	HMF 71 T6 0,75kW (A5:6) F400	923	2,2	0,75	15.440	53	87	1
26180656__AF	HMF 80 T6 0,75kW (A5:6) F400	923	2,2	0,75	17.380	59	96	1
26181656__AF	HMF 80 T6 1,1kW (A5:6) F400	920	3,1	1,10	19.520	55	100	1
26182656__AF	HMF 80 T6 1,5kW (A5:6) F400	933	3,6	1,50	21.820	55	106	1
26183656__AF	HMF 80 T6 2,2kW (A5:6) F400	948	5,23	2,20	23.930	56	115	1
26191634__AF	HMF 90 T6 1,5kW (A3:4) F400	933	3,6	1,50	25.600	54	120	1
26191638__AF	HMF 90 T6 1,5kW (A3:8) F400	933	3,6	1,50	20.700	60	124	1
26192634__AF	HMF 90 T6 2,2kW (A3:4) F400	948	5,23	2,20	30.000	54	129	1
26192638__AF	HMF 90 T6 2,2kW (A3:8) F400	948	5,23	2,20	25.700	58	132	1
26193638__AF	HMF 90 T6 3kW (A3:8) F400	965	7,42	3	30.800	57	156	1
26194638__AF	HMF 90 T6 4kW (A3:8) F400	963	8,97	4	34.100	57	162	1

Code	Model	R.P.M.	Rated I. (A) 400V	Rated power kW	Max. Airflow m3/h	Sound db (A)*	Weight	Connect. diagram
26110634__AF	HMF 100 T6 1,5kW (A3:4) F400	933	3,6	1,50	29.600	62	132	1
26111634__AF	HMF 100 T6 2,2kW (A3:4) F400	948	5,23	2,20	35.000	61	141	1
26111638__AF	HMF 100 T6 2,2kW (A3:8) F400	948	5,23	2,20	27.600	70	143	1
26112634__AF	HMF 100 T6 3kW (A3:4) F400	965	7,42	3	40.400	60	165	1
26112638__AF	HMF 100 T6 3kW (A3:8) F400	965	7,42	3	34.000	66	169	1
26113634__AF	HMF 100 T6 4kW (A3:4) F400	963	8,97	4	42.200	61	171	1
26113638__AF	HMF 100 T6 4kW (A3:8) F400	963	8,97	4	41.200	63	175	1
26114638__AF	HMF 100 T6 5,5kW (A3:8) F400	960	12,8	5,50	48.600	63	179	1
26120634__AF	HMF 112 T6 2,2kW (A3:4) F400	948	5,23	2,20	41.000	64	177	1
26121634__AF	HMF 112 T6 3kW (A3:4) F400	965	7,42	3	48.900	63	198	1
26121638__AF	HMF 112 T6 3kW (A3:8) F400	965	7,42	3	37.300	72	200	1
26122634__AF	HMF 112 T6 4kW (A3:4) F400	963	8,97	4	55.900	62	204	1
26122638__AF	HMF 112 T6 4kW (A3:8) F400	963	8,97	4	46.900	69	204	1
26123634__AF	HMF 112 T6 5,5kW (A3:4) F400	960	12,8	5,50	58.000	63	207	1
26123638__AF	HMF 112 T6 5,5kW (A3:8) F400	960	12,8	5,50	56.600	66	214	1
26124638__AF	HMF 112 T6 7,5kW (A3:8) F400	970	15	7,50	64.600	65	253	1
27102634__AF	HMF 125 T6 3kW (A3:4) F400	965	7,42	3	51.700	72	219	1
27103634__AF	HMF 125 T6 4kW (A3:4) F400	963	8,97	4	59.100	68	225	1
27104634__AF	HMF 125 T6 5,5kW (A3:4) F400	960	12,8	5,50	69.400	65	229	1
27104638__AF	HMF 125 T6 5,5kW (A3:8) F400	960	12,8	5,50	54.800	77	240	1
27105634__AF	HMF 125 T6 7,5kW (A3:4) F400	970	15	7,50	78.400	65	273	1
27105638__AF	HMF 125 T6 7,5kW (A3:8) F400	970	15	7,50	67.700	72	284	1
27106638__AF	HMF 125 T6 11kW (A3:8) F400	970	22	11	83.800	68	304	1
27107638__AF	HMF 125 T6 15kW (A3:8) F400	970	27,9	15	87.200	67	342	1

2 SPEED MOTOR / 4/6 poles

Code	Model	R.P.M.	Rated I. (A) 400V	Rated power kW	Max. Airflow m3/h	Sound db (A)*	Weight	Connect. diagram
26145656__AS	HMF 45 T4/T6 0,75/0,25kW (A5:6) F400	1430	1,94/27,2	0.75/0.25	6.650	-	28	2
26151656__AS	HMF 50 T4/T6 0,75/0,25kW (A5:6) F400	1430	1,94/27,2	0.75/0.25	8.760	-	38	2
26159656__AS	HMF 56 T4/T6 0,75/0,25kW (A5:6) F400	1430	1,94/27,2	0.75/0.25	10.270	-	72	2
26160656__AS	HMF 56 T4/T6 1,1/0,3kW (A5:6) F400	1440	2,84/1,32	1.1/0.3	11.890	-	77	2
26161656__AS	HMF 56 T4/T6 1,5/0,37kW (A5:6) F400	1440	3,65/1,49	1.5/0.37	13.870	-	78	2
26165656__AS	HMF 63 T4/T6 0,75/0,25kW (A5:6) F400	1430	1,94/27,2	0.75/0.25	11.420	-	74	2
26166656__AS	HMF 63 T4/T6 1,1/0,3kW (A5:6) F400	1440	2,84/1,32	1.1/0.3	14.010	-	79	2
26167656__AS	HMF 63 T4/T6 1,5/0,37kW (A5:6) F400	1440	3,65/1,49	1.5/0.37	15.780	-	80	2
26168656__AS	HMF 63 T4/T6 2,2/0,7kW (A5:6) F400	1430	4,91/1,62	2.2/0.7	17.690	-	86	2

Code	Model	R.P.M.	Rated I. (A) 400V	Rated power kW	Max. Airflow m3/h	Sound db (A)*	Weight	Connect. diagram
26172656__AS	HMF 71 T4/T6 0,75/0,25kW (A5:6) F400	1430	1,94/27,2	0.75/0.25	12.950	-	91	2
26173656__AS	HMF 71 T4/T6 1,1/0,3kW (A5:6) F400	1440	2,84/1,32	1.1/0.3	15.960	-	93	2
26174656__AS	HMF 71 T4/T6 1,5/0,37kW (A5:6) F400	1440	3,65/1,49	1.5/0.37	18.960	-	94	2
26175656__AS	HMF 71 T4/T6 2,2/0,7kW (A5:6) F400	1430	4,91/1,62	2.2/0.7	22.040	-	96	2
26176656__AS	HMF 71 T4/T6 3/1kW (A5:6) F400	1460	6,85/2,48	3/1	23.900	-	99	2
26184656__AS	HMF 80 T4/T6 3/1kW (A5:6) F400	1460	6,85/2,48	3/1	28.540	-	110	2
26185656__AS	HMF 80 T4/T6 4,5/1,5kW (A5:6) F400	1465	10,2/3,86	4.5/1.5	32.300	-	123	2
26193634__AS	HMF 90 T4/T6 3/1kW (A3:4) F400	1460	6,85/2,48	3/1	27.600	57	124	2
26194634__AS	HMF 90 T4/T6 4,5/1,5kW (A3:4) F400	1465	10,2/3,86	4.5/1.5	35.300	55	137	2
26194638__AS	HMF 90 T4/T6 4,5/1,5kW (A3:8) F400	1465	10,2/3,86	4.5/1.5	26.800	62	140	2
26195634__AS	HMF 90 T4/T6 6/2,2kW (A3:4) F400	1465	13,7/5,38	6/2.2	41.100	54	150	2
26195638__AS	HMF 90 T4/T6 6/2,2kW (A3:8) F400	1465	13,7/5,38	6/2.2	32.000	61	154	2
26196634__AS	HMF 90 T4/T6 10/3,3kW (A3:4) F400	1475	22/6,96	10/3.3	46.300	54	164	2
26196638__AS	HMF 90 T4/T6 10/3,3kW (A3:8) F400	1475	22/6,96	10/3.3	45.000	57	168	2
26198638__AS	HMF 90 T4/T6 14/4,5kW (A3:8) F400	1480	29,5/8,74	14/4.5	52.600	57	195	2
26113634__AS	HMF 100 T4/T6 4,5/1,5kW (A3:4) F400	1465	10,2/3,86	4.5/1.5	39.900	63	145	2
26114634__AS	HMF 100 T4/T6 6/2,2kW (A3:4) F400	1465	13,7/5,38	6/2.2	45.600	62	163	2
26115634__AS	HMF 100 T4/T6 10/3,3kW (A3:4) F400	1475	22/6,96	10/3.3	59.500	61	177	2
26115638__AS	HMF 100 T4/T6 10/3,3kW (A3:8) F400	1475	22/6,96	10/3.3	49.200	66	185	2
26117634__AS	HMF 100 T4/T6 14/4,5kW (A3:4) F400	1480	29,5/8,74	14/4.5	65.200	61	204	2
26117638__AS	HMF 100 T4/T6 14/4,5kW (A3:8) F400	1480	29,5/8,74	14/4.5	59.700	64	207	2
26117638__AS	HMF 100 T4/T6 16/6,5kW (A3:8) F400	1450	28,4/11,2	16/6.5	63.600	64	235	2
26119638__AS	HMF 100 T4/T6 20/8,5kW (A3:8) F400	1465	34,9/12,5	20/8.5	75.100	63	283	2
26123634__AS	HMF 112 T4/T6 6/2,2kW (A3:4) F400	1465	13,7/5,38	6/2.2	54.800	65	182	2
26124634__AS	HMF 112 T4/T6 10/3,3kW (A3:4) F400	1475	22/6,96	10/3.3	71.700	63	206	2
26126634__AS	HMF 112 T4/T6 14/4,5kW (A3:4) F400	1480	29,5/8,74	14/4.5	82.900	62	230	2
26126638__AS	HMF 112 T4/T6 14/4,5kW (A3:8) F400	1480	29,5/8,74	14/4.5	67.500	70	233	2
26126634__AS	HMF 112 T4/T6 16/6,5kW (A3:4) F400	1450	28,4/11,2	16/6.5	86.200	63	255	2
26126638__AS	HMF 112 T4/T6 16/6,5kW (A3:8) F400	1450	28,4/11,2	16/6.5	77.400	68	259	2
26128634__AS	HMF 112 T4/T6 20/8,5kW (A3:4) F400	1465	34,9/12,5	20/8.5	89.500	63	298	2
26128638__AS	HMF 112 T4/T6 20/8,5kW (A3:8) F400	1465	34,9/12,5	20/8.5	82.400	67	302	2
26129638__AS	HMF 112 T4/T6 26/9kW (A3:8) F400	1480	47,7/16,3	26/9	95.700	65	303	2
26130638__AS	HMF 112 T4/T6 34/12kW (A3:8) F400	1485	65,6/18,6	34/12	99.700	65	357	2
27106634__AS	HMF 125 T4/T6 10/3,3kW (A3:4) F400	1475	22/6,96	10/3.3	74.100	73	248	2
27107634__AS	HMF 125 T4/T6 14/4,5kW (A3:4) F400	1480	29,5/8,74	14/4.5	85.500	70	254	2
27108634__AS	HMF 125 T4/T6 16/6,5kW (A3:4) F400	1450	28,4/11,2	16/6.5	96.900	66	282	2
27109634__AS	HMF 125 T4/T6 20/8,5kW (A3:4) F400	1465	34,9/12,5	20/8.5	107.000	65	330	2
27109638__AS	HMF 125 T4/T6 20/8,5kW (A3:8) F400	1465	34,9/12,5	20/8.5	84.500	77	338	2
27110634__AS	HMF 125 T4/T6 26/9kW (A3:4) F400	1480	47,7/16,3	26/9	116.000	65	331	2

Code	Model	R.P.M.	Rated I. (A) 400V	Rated power kW	Max. Airflow m3/h	Sound db (A)*	Weight	Connect. diagram
27110638__AS	HMF 125 T4/T6 26/9kW (A3:8) F400	1480	47,7/16,3	26/9	105.000	72	339	2
27110634__AS	HMF 125 T4/T6 34/12kW (A3:4) F400	1485	65,6/18,6	34/12	121.000	66	391	2
27110638__AS	HMF 125 T4/T6 34/12kW (A3:8) F400	1485	65,6/18,6	34/12	118.000	69	399	2
27112638__AS	HMF 125 T4/T6 40/14kW (A3:8) F400	1485	75,5/28	40/14	129.000	68	500	2

2 SPEED MOTOR / 4/8 poles

Code	Model	R.P.M.	Rated I. (A) 400V	Rated power kW	Max. Airflow m3/h	Sound db (A)*	Weight	Connect. diagram
26147606__AW	HMF 45 T4/T8 0,8/0,2kW (A5:6) F400	1430	2/0,89	0.8/0.2	6.650	35	28	3
26150606__AW	HMF 50 T4/T8 0,8/0,2kW (A5:6) F400	1430	2/0,89	0.8/0.2	8.760	37	38	3
26159656__AW	HMF 56 T4/T8 0,8/0,2kW (A5:6) F400	1430	2/0,89	0.8/0.2	10.270	42	71	3
26160656__AW	HMF 56 T4/T8 1,2/0,3kW (A5:6) F400	1410	2,92/1,29	1.2/0.3	11.890	40	77	3
26161656__AW	HMF 56 T4/T8 1,6/0,4kW (A5:6) F400	1440	3,8/1,69	1.6/0.4	13.870	42	78	3
26165656__AW	HMF 63 T4/T8 0,8/0,2kW (A5:6) F400	1430	2/0,89	0.8/0.2	11.420	45	74	3
26166656__AW	HMF 63 T4/T8 1,2/0,3kW (A5:6) F400	1410	2,92/1,29	1.2/0.3	14.010	46	79	3
26167656__AW	HMF 63 T4/T8 1,6/0,4kW (A5:6) F400	1440	3,8/1,69	1.6/0.4	15.780	42	80	3
26168656__AW	HMF 63 T4/T8 2,2/0,37kW (A5:6) F400	1440	4,84/2	2.2/0.37	17.690	43	86	3
26172656__AW	HMF 71 T4/T8 0,8/0,2kW (A5:6) F400	1430	2/0,89	0.8/0.2	12.950	50	91	3
26173656__AW	HMF 71 T4/T8 1,2/0,3kW (A5:6) F400	1410	2,92/1,29	1.2/0.3	15.960	49	93	3
26174656__AW	HMF 71 T4/T8 1,6/0,4kW (A5:6) F400	1440	3,8/1,69	1.6/0.4	18.960	48	94	3
26175656__AW	HMF 71 T4/T8 2,2/0,37kW (A5:6) F400	1440	4,84/2	2.2/0.37	22.040	46	96	3
26176656__AW	HMF 71 T4/T8 3/0,55kW (A5:6) F400	1428	7,1/5,1	3/0.55	23.900	48	99	3
26184656__AW	HMF 80 T4/T8 3/0,55kW (A5:6) F400	1428	7,1/5,1	3/0.55	28.540	48	110	3
26185656__AW	HMF 80 T4/T8 4/0,75kW (A5:6) F400	1430	8,6/2,6	4/0.75	32.300	49	123	3
26193634__AW	HMF 90 T4/T8 2,8/0,7kW (A3:4) F400	1440	6/2,4	2.8/0.7	27.600	50	118	3
26194634__AW	HMF 90 T4/T8 4/0,75kW (A3:4) F400	1430	8,6/2,6	4/0.75	32.700	49	137	3
26195634__AW	HMF 90 T4/T8 5,5/1,1kW (A3:4) F400	1454	10,9/3,32	5.5/1.1	39.500	47	150	3
26195638__AW	HMF 90 T4/T8 5,5/1,1kW (A3:8) F400	1454	10,9/3,32	5.5/1.1	29.400	55	154	3
26196634__AW	HMF 90 T4/T8 7,5/1,5kW (A3:4) F400	1461	14,9/3,7	7.5/1.5	44.600	47	164	3
26196638__AW	HMF 90 T4/T8 7,5/1,5kW (A3:8) F400	1461	14,9/3,7	7.5/1.5	37.100	53	168	3
26197634__AW	HMF 90 T4/T8 11/3kW (A3:4) F400	1455	21,7/7	11/3	46.300	49	194	3
26197638__AW	HMF 90 T4/T8 11/3kW (A3:8) F400	1455	21,7/7	11/3	47.600	50	195	3
26198638__AW	HMF 90 T4/T8 14/3,5kW (A3:8) F400	1450	26,5/8,45	14/3.5	52.600	51	235	3
26114634__AW	HMF 100 T4/T8 5,5/1,1kW (A3:4) F400	1454	10,9/3,32	5.5/1.1	45.600	56	163	3
26115634__AW	HMF 100 T4/T8 7,5/1,5kW (A3:4) F400	1461	14,9/3,7	7.5/1.5	51.400	55	177	3
26115638__AW	HMF 100 T4/T8 7,5/1,5kW (A3:8) F400	1461	14,9/3,7	7.5/1.5	39.400	65	182	3
26116634__AW	HMF 100 T4/T8 11/3kW (A3:4) F400	1455	21,7/7	11/3	62.300	54	204	3

Code	Model	R.P.M.	Rated I. (A) 400V	Rated power kW	Max. Airflow m3/h	Sound db (A)*	Weight	Connect. diagram
26116638__AW	HMF 100 T4/T8 11/3kW (A3:8) F400	1455	21,7/7	11/3	52.500	60	207	3
26117634__AW	HMF 100 T4/T8 14/3,5kW (A3:4) F400	1450	26,5/8,45	14/3.5	65.200	55	230	3
26117638__AW	HMF 100 T4/T8 14/3,5kW (A3:8) F400	1450	26,5/8,45	14/3.5	59.700	58	235	3
26118638__AW	HMF 100 T4/T8 17/4,3kW (A3:8) F400	1475	33,4/12,7	17/4.3	67.500	57	225	3
26119638__AW	HMF 100 T4/T8 20/5kW (A3:8) F400	1470	38,6/14,1	20/5	75.100	57	235	3
26123634__AW	HMF 112 T4/T8 5,5/1,1kW (A3:4) F400	1454	10,9/3,32	5.5/1.1	50.600	59	165	3
26124634__AW	HMF 112 T4/T8 7,5/1,5kW (A3:4) F400	1461	14,9/3,7	7.5/1.5	59.100	59	206	3
26125634__AW	HMF 112 T4/T8 11/3kW (A3:4) F400	1455	21,7/7	11/3	75.500	56	230	3
26125638__AW	HMF 112 T4/T8 11/3kW (A3:8) F400	1455	21,7/7	11/3	52.700	67	233	3
26126634__AW	HMF 112 T4/T8 14/3,5kW (A3:4) F400	1450	26,5/8,45	14/3.5	82.900	56	255	3
26126638__AW	HMF 112 T4/T8 14/3,5kW (A3:8) F400	1450	26,5/8,45	14/3.5	67.500	64	257	3
26126634__AW	HMF 112 T4/T8 17/4,3kW (A3:4) F400	1475	33,4/12,7	17/4.3	89.500	56	235	3
26126638__AW	HMF 112 T4/T8 17/4,3kW (A3:8) F400	1475	33,4/12,7	17/4.3	77.400	62	239	3
26128638__AW	HMF 112 T4/T8 20/5kW (A3:8) F400	1470	38,6/14,1	20/5	82.400	61	259	3
26128638__AW	HMF 112 T4/T8 28/6,5kW (A3:8) F400	1480	52/18	28/6.5	99.700	59	302	3
27106634__AW	HMF 125 T4/T8 11/3kW (A3:4) F400	1455	21,7/7	11/3	74.100	67	254	3
27107634__AW	HMF 125 T4/T8 14/3,5kW (A3:4) F400	1450	26,5/8,45	14/3.5	85.500	64	280	3
27108634__AW	HMF 125 T4/T8 17/4,3kW (A3:4) F400	1475	33,4/12,7	17/4.3	96.900	60	254	3
27109634__AW	HMF 125 T4/T8 20/5kW (A3:4) F400	1470	38,6/14,1	20/5	107.000	59	282	3
27108638__AW	HMF 125 T4/T8 20/5kW (A3:8) F400	1470	38,6/14,1	20/5	84.500	71	287	3
27109634__AW	HMF 125 T4/T8 28/6,5kW (A3:4) F400	1480	52/18	28/6.5	121.000	59	330	3
27110638__AW	HMF 125 T4/T8 28/6,5kW (A3:8) F400	1480	52/18	28/6.5	105.000	66	338	3
27111638__AW	HMF 125 T4/T8 37/9,2kW (A3:8) F400	1485	74,2/25,4	37/9.2	124.000	62	480	3
27112638__AW	HMF 125 T4/T8 44/11kW (A3:8) F400	1480	80,2/27,2	44/11	135.000	61	545	3

Notes:
 * Total sound pressure level at the point of maximum flow measured in dB(A) in the suction measured in free field at a distance of 6m from the source

Dimensions

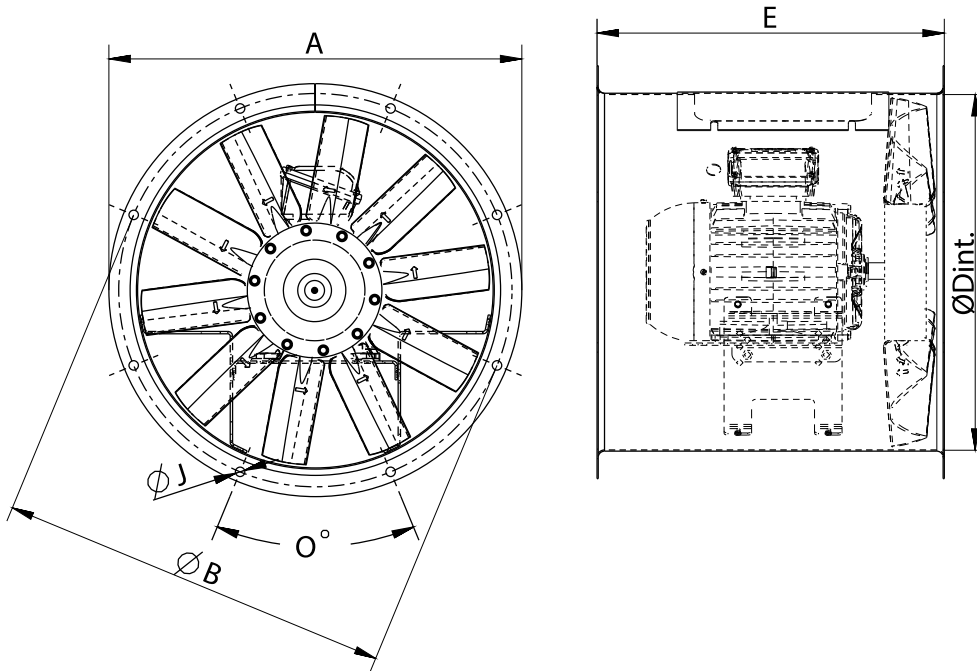

Model	E	O	ØA	ØB	ØDint	ØJ
HMF 45 T4 0,75kW (A5:6) F400	455	8x45°	525	500	452	12
HMF 45 T4/T6 0,75/0,25kW (A5:6) F400	455	8x45°	525	500	452	12
HMF 45 T4/T8 0,8/0,2kW (A5:6) F400	455	8x45°	525	500	452	12
HMF 50 T4 0,75kW (A5:6) F400	440	12x30°	600	560	504	12
HMF 50 T6 0,75kW (A5:6) F400	440	12x30°	600	560	504	12
HMF 50 T4/T6 0,75/0,25kW (A5:6) F400	440	12x30°	600	560	504	12
HMF 50 T4/T8 0,8/0,2kW (A5:6) F400	440	12x30°	600	560	504	12
HMF 56 T4 0,75kW (A5:6) F400	560	12x30°	646	620	559	12
HMF 56 T4 1,1kW (A5:6) F400	560	12x30°	646	620	559	12
HMF 56 T4 1,5kW (A5:6) F400	560	12x30°	646	620	559	12
HMF 56 T6 0,75kW (A5:6) F400	560	12x30°	646	620	559	12
HMF 56 T4/T6 0,75/0,25kW (A5:6) F400	560	12x30°	646	620	559	12
HMF 56 T4/T6 1,1/0,3kW (A5:6) F400	560	12x30°	646	620	559	12
HMF 56 T4/T6 1,5/0,37kW (A5:6) F400	560	12x30°	646	620	559	12
HMF 56 T4/T8 0,8/0,2kW (A5:6) F400	560	12x30°	646	620	559	12
HMF 56 T4/T8 1,2/0,3kW (A5:6) F400	560	12x30°	646	620	559	12
HMF 56 T4/T8 1,6/0,4kW (A5:6) F400	560	12x30°	646	620	559	12
HMF 63 T4 0,75kW (A5:6) F400	550	12x30°	725	690	633	12
HMF 63 T4 1,1kW (A5:6) F400	550	12x30°	725	690	633	12
HMF 63 T4 1,5kW (A5:6) F400	550	12x30°	725	690	633	12
HMF 63 T4 2,2kW (A5:6) F400	550	12x30°	725	690	633	12

Model	E	O	ØA	ØB	ØDint	ØJ
HMF 63 T6 0,75kW (A5:6) F400	550	12x30°	725	690	633	12
HMF 63 T4/T6 0,75/0,25kW (A5:6) F400	550	12x30°	725	690	633	12
HMF 63 T4/T6 1,1/0,3kW (A5:6) F400	550	12x30°	725	690	633	12
HMF 63 T4/T6 1,5/0,37kW (A5:6) F400	550	12x30°	725	690	633	12
HMF 63 T4/T6 2,2/0,7kW (A5:6) F400	550	12x30°	725	690	633	12
HMF 63 T4/T8 0,8/0,2kW (A5:6) F400	550	12x30°	725	690	633	12
HMF 63 T4/T8 1,2/0,3kW (A5:6) F400	550	12x30°	725	690	633	12
HMF 63 T4/T8 1,6/0,4kW (A5:6) F400	550	12x30°	725	690	633	12
HMF 63 T4/T8 2,2/0,37kW (A5:6) F400	550	12x30°	725	690	633	12
HMF 71 T4 0,75kW (A5:6) F400	600	16x22,5°	802	770	715	12
HMF 71 T4 1,1kW (A5:6) F400	600	16x22,5°	802	770	715	12
HMF 71 T4 1,5kW (A5:6) F400	600	16x22,5°	802	770	715	12
HMF 71 T4 2,2kW (A5:6) F400	600	16x22,5°	802	770	715	12
HMF 71 T4 3kW (A5:6) F400	600	16x22,5°	802	770	715	12
HMF 71 T6 0,75kW (A5:6) F400	600	16x22,5°	802	770	715	12
HMF 71 T4/T6 0,75/0,25kW (A5:6) F400	600	16x22,5°	802	770	715	12
HMF 71 T4/T6 1,1/0,3kW (A5:6) F400	600	16x22,5°	802	770	715	12
HMF 71 T4/T6 1,5/0,37kW (A5:6) F400	600	16x22,5°	802	770	715	12
HMF 71 T4/T6 2,2/0,7kW (A5:6) F400	600	16x22,5°	802	770	715	12
HMF 71 T4/T6 3/1kW (A5:6) F400	600	16x22,5°	802	770	715	12
HMF 71 T4/T8 0,8/0,2kW (A5:6) F400	600	16x22,5°	802	770	715	12
HMF 71 T4/T8 1,2/0,3kW (A5:6) F400	600	16x22,5°	802	770	715	12
HMF 71 T4/T8 1,6/0,4kW (A5:6) F400	600	16x22,5°	802	770	715	12
HMF 71 T4/T8 2,2/0,37kW (A5:6) F400	600	16x22,5°	802	770	715	12
HMF 71 T4/T8 3/0,55kW (A5:6) F400	600	16x22,5°	802	770	715	12
HMF 80 T4 3kW (A5:6) F400	600	16x22,5°	892	860	801	12
HMF 80 T4 4kW (A5:6) F400	600	16x22,5°	892	860	801	12
HMF 80 T6 0,75kW (A5:6) F400	600	16x22,5°	892	860	801	12
HMF 80 T6 1,1kW (A5:6) F400	600	16x22,5°	892	860	801	12
HMF 80 T6 1,5kW (A5:6) F400	600	16x22,5°	892	860	801	12
HMF 80 T6 2,2kW (A5:6) F400	600	16x22,5°	892	860	801	12
HMF 80 T4/T6 3/1kW (A5:6) F400	600	16x22,5°	892	860	801	12
HMF 80 T4/T6 4,5/1,5kW (A5:6) F400	600	16x22,5°	892	860	801	12
HMF 80 T4/T8 3/0,55kW (A5:6) F400	600	16x22,5°	892	860	801	12
HMF 80 T4/T8 4/0,75kW (A5:6) F400	600	16x22,5°	892	860	801	12
HMF 90 T4 3kW (A3:4) F400	820	16x22,5°	1000	970	903,5	12
HMF 90 T4 4kW (A3:4) F400	820	16x22,5°	1000	970	903,5	12
HMF 90 T4 5,5kW (A3:4) F400	820	16x22,5°	1000	970	903,5	12
HMF 90 T4 5,5kW (A3:8) F400	820	16x22,5°	1000	970	903,5	12
HMF 90 T4 7,5kW (A3:4) F400	820	16x22,5°	1000	970	903,5	12

Model	E	O	ØA	ØB	ØDint	ØJ
HMF 90 T4 7,5kW (A3:8) F400	820	16x22,5°	1000	970	903,5	12
HMF 90 T4 11kW (A3:4) F400	820	16x22,5°	1000	970	903,5	12
HMF 90 T4 11kW (A3:8) F400	820	16x22,5°	1000	970	903,5	12
HMF 90 T4 15kW (A3:8) F400	820	16x22,5°	1000	970	903,5	12
HMF 90 T6 1,5kW (A3:4) F400	820	16x22,5°	1000	970	903,5	12
HMF 90 T6 1,5kW (A3:8) F400	820	16x22,5°	1000	970	903,5	12
HMF 90 T6 2,2kW (A3:4) F400	820	16x22,5°	1000	970	903,5	12
HMF 90 T6 2,2kW (A3:8) F400	820	16x22,5°	1000	970	903,5	12
HMF 90 T6 3kW (A3:8) F400	820	16x22,5°	1000	970	903,5	12
HMF 90 T6 4kW (A3:8) F400	820	16x22,5°	1000	970	903,5	12
HMF 90 T4/T6 3/1kW (A3:4) F400	820	16x22,5°	1000	970	903,5	12
HMF 90 T4/T6 4,5/1,5kW (A3:4) F400	820	16x22,5°	1000	970	903,5	12
HMF 90 T4/T6 4,5/1,5kW (A3:8) F400	820	16x22,5°	1000	970	903,5	12
HMF 90 T4/T6 6/2,2kW (A3:4) F400	820	16x22,5°	1000	970	903,5	12
HMF 90 T4/T6 6/2,2kW (A3:8) F400	820	16x22,5°	1000	970	903,5	12
HMF 90 T4/T6 10/3,3kW (A3:4) F400	820	16x22,5°	1000	970	903,5	12
HMF 90 T4/T6 10/3,3kW (A3:8) F400	820	16x22,5°	1000	970	903,5	12
HMF 90 T4/T6 14/4,5kW (A3:8) F400	820	16x22,5°	1000	970	903,5	12
HMF 90 T4/T8 2,8/0,7kW (A3:4) F400	820	16x22,5°	1000	970	903,5	12
HMF 90 T4/T8 4/0,75kW (A3:4) F400	820	16x22,5°	1000	970	903,5	12
HMF 90 T4/T8 5,5/1,1kW (A3:4) F400	820	16x22,5°	1000	970	903,5	12
HMF 90 T4/T8 5,5/1,1kW (A3:8) F400	820	16x22,5°	1000	970	903,5	12
HMF 90 T4/T8 7,5/1,5kW (A3:4) F400	820	16x22,5°	1000	970	903,5	12
HMF 90 T4/T8 7,5/1,5kW (A3:8) F400	820	16x22,5°	1000	970	903,5	12
HMF 90 T4/T8 11/3kW (A3:4) F400	820	16x22,5°	1000	970	903,5	12
HMF 90 T4/T8 11/3kW (A3:8) F400	820	16x22,5°	1000	970	903,5	12
HMF 90 T4/T8 14/3,5kW (A3:8) F400	820	16x22,5°	1000	970	903,5	12
HMF 100 T4 5,5kW (A3:4) F400	820	16x22,5°	1115	1070	1013	12
HMF 100 T4 7,5kW (A3:4) F400	820	16x22,5°	1115	1070	1013	12
HMF 100 T4 7,5kW (A3:8) F400	820	16x22,5°	1115	1070	1013	12
HMF 100 T4 11kW (A3:4) F400	820	16x22,5°	1115	1070	1013	12
HMF 100 T4 11kW (A3:8) F400	820	16x22,5°	1115	1070	1013	12
HMF 100 T4 15kW (A3:4) F400	820	16x22,5°	1115	1070	1013	12
HMF 100 T4 15kW (A3:8) F400	820	16x22,5°	1115	1070	1013	12
HMF 100 T4 18,5kW (A3:8) F400	820	16x22,5°	1115	1070	1013	12
HMF 100 T4 22kW (A3:8) F400	820	16x22,5°	1115	1070	1013	12
HMF 100 T6 1,5kW (A3:4) F400	820	16x22,5°	1115	1070	1013	12
HMF 100 T6 2,2kW (A3:4) F400	820	16x22,5°	1115	1070	1013	12
HMF 100 T6 2,2kW (A3:8) F400	820	16x22,5°	1115	1070	1013	12
HMF 100 T6 3kW (A3:4) F400	820	16x22,5°	1115	1070	1013	12

Model	E	O	ØA	ØB	ØDint	ØJ
HMF 100 T6 3kW (A3:8) F400	820	16x22,5°	1115	1070	1013	12
HMF 100 T6 4kW (A3:4) F400	820	16x22,5°	1115	1070	1013	12
HMF 100 T6 4kW (A3:8) F400	820	16x22,5°	1115	1070	1013	12
HMF 100 T6 5,5kW (A3:8) F400	820	16x22,5°	1115	1070	1013	12
HMF 100 T4/T6 4,5/1,5kW (A3:4) F400	820	16x22,5°	1115	1070	1013	12
HMF 100 T4/T6 6/2,2kW (A3:4) F400	820	16x22,5°	1115	1070	1013	12
HMF 100 T4/T6 10/3,3kW (A3:4) F400	820	16x22,5°	1115	1070	1013	12
HMF 100 T4/T6 10/3,3kW (A3:8) F400	820	16x22,5°	1115	1070	1013	12
HMF 100 T4/T6 14/4,5kW (A3:4) F400	820	16x22,5°	1115	1070	1013	12
HMF 100 T4/T6 14/4,5kW (A3:8) F400	820	16x22,5°	1115	1070	1013	12
HMF 100 T4/T6 16/6,5kW (A3:8) F400	820	16x22,5°	1115	1070	1013	12
HMF 100 T4/T6 20/8,5kW (A3:8) F400	820	16x22,5°	1115	1070	1013	12
HMF 100 T4/T8 5,5/1,1kW (A3:4) F400	820	16x22,5°	1115	1070	1013	12
HMF 100 T4/T8 7,5/1,5kW (A3:4) F400	820	16x22,5°	1115	1070	1013	12
HMF 100 T4/T8 7,5/1,5kW (A3:8) F400	820	16x22,5°	1115	1070	1013	12
HMF 100 T4/T8 11/3kW (A3:4) F400	820	16x22,5°	1115	1070	1013	12
HMF 100 T4/T8 11/3kW (A3:8) F400	820	16x22,5°	1115	1070	1013	12
HMF 100 T4/T8 14/3,5kW (A3:4) F400	820	16x22,5°	1115	1070	1013	12
HMF 100 T4/T8 14/3,5kW (A3:8) F400	820	16x22,5°	1115	1070	1013	12
HMF 100 T4/T8 17/4,3kW (A3:8) F400	820	16x22,5°	1115	1070	1013	12
HMF 100 T4/T8 20/5kW (A3:8) F400	820	16x22,5°	1115	1070	1013	12
HMF 112 T4 5,5kW (A3:4) F400	1000	16x22,5°	1234	1190	1132	12
HMF 112 T4 7,5kW (A3:4) F400	1000	16x22,5°	1234	1190	1132	12
HMF 112 T4 11kW (A3:4) F400	1000	16x22,5°	1234	1190	1132	12
HMF 112 T4 11kW (A3:8) F400	1000	16x22,5°	1234	1190	1132	12
HMF 112 T4 15kW (A3:4) F400	1000	16x22,5°	1234	1190	1132	12
HMF 112 T4 15kW (A3:8) F400	1000	16x22,5°	1234	1190	1132	12
HMF 112 T4 18,5kW (A3:4) F400	1000	16x22,5°	1234	1190	1132	12
HMF 112 T4 18,5kW (A3:8) F400	1000	16x22,5°	1234	1190	1132	12
HMF 112 T4 22kW (A3:8) F400	1000	16x22,5°	1234	1190	1132	12
HMF 112 T4 30kW (A3:8) F400	1000	16x22,5°	1234	1190	1132	12
HMF 112 T6 2,2kW (A3:4) F400	1000	16x22,5°	1234	1190	1132	12
HMF 112 T6 3kW (A3:4) F400	1000	16x22,5°	1234	1190	1132	12
HMF 112 T6 3kW (A3:8) F400	1000	16x22,5°	1234	1190	1132	12
HMF 112 T6 4kW (A3:4) F400	1000	16x22,5°	1234	1190	1132	12
HMF 112 T6 4kW (A3:8) F400	1000	16x22,5°	1234	1190	1132	12
HMF 112 T6 5,5kW (A3:4) F400	1000	16x22,5°	1234	1190	1132	12
HMF 112 T6 5,5kW (A3:8) F400	1000	16x22,5°	1234	1190	1132	12
HMF 112 T6 7,5kW (A3:8) F400	1000	16x22,5°	1234	1190	1132	12
HMF 112 T4/T6 6/2,2kW (A3:4) F400	1000	16x22,5°	1234	1190	1132	12

Model	E	O	ØA	ØB	ØDint	ØJ
HMF 112 T4/T6 10/3,3kW (A3:4) F400	1000	16x22,5°	1234	1190	1132	12
HMF 112 T4/T6 14/4,5kW (A3:4) F400	1000	16x22,5°	1234	1190	1132	12
HMF 112 T4/T6 14/4,5kW (A3:8) F400	1000	16x22,5°	1234	1190	1132	12
HMF 112 T4/T6 16/6,5kW (A3:4) F400	1000	16x22,5°	1234	1190	1132	12
HMF 112 T4/T6 16/6,5kW (A3:8) F400	1000	16x22,5°	1234	1190	1132	12
HMF 112 T4/T6 20/8,5kW (A3:4) F400	1000	16x22,5°	1234	1190	1132	12
HMF 112 T4/T6 20/8,5kW (A3:8) F400	1000	16x22,5°	1234	1190	1132	12
HMF 112 T4/T6 26/9kW (A3:8) F400	1000	16x22,5°	1234	1190	1132	12
HMF 112 T4/T6 34/12kW (A3:8) F400	1000	16x22,5°	1234	1190	1132	12
HMF 112 T4/T8 5,5/1,1kW (A3:4) F400	1000	16x22,5°	1234	1190	1132	12
HMF 112 T4/T8 7,5/1,5kW (A3:4) F400	1000	16x22,5°	1234	1190	1132	12
HMF 112 T4/T8 11/3kW (A3:4) F400	1000	16x22,5°	1234	1190	1132	12
HMF 112 T4/T8 11/3kW (A3:8) F400	1000	16x22,5°	1234	1190	1132	12
HMF 112 T4/T8 14/3,5kW (A3:4) F400	1000	16x22,5°	1234	1190	1132	12
HMF 112 T4/T8 14/3,5kW (A3:8) F400	1000	16x22,5°	1234	1190	1132	12
HMF 112 T4/T8 17/4,3kW (A3:4) F400	1000	16x22,5°	1234	1190	1132	12
HMF 112 T4/T8 17/4,3kW (A3:8) F400	1000	16x22,5°	1234	1190	1132	12
HMF 112 T4/T8 20/5kW (A3:8) F400	1000	16x22,5°	1234	1190	1132	12
HMF 112 T4/T8 28/6,5kW (A3:8) F400	1000	16x22,5°	1234	1190	1132	12
HMF 125 T4 11kW (A3:4) F400	1000	20x18°	1365	1320	1263	15
HMF 125 T4 15kW (A3:4) F400	1000	20x18°	1365	1320	1263	15
HMF 125 T4 18,5kW (A3:4) F400	1000	20x18°	1365	1320	1263	15
HMF 125 T4 18,5kW (A3:8) F400	1000	20x18°	1365	1320	1263	15
HMF 125 T4 22kW (A3:4) F400	1000	20x18°	1365	1320	1263	15
HMF 125 T4 22kW (A3:8) F400	1000	20x18°	1365	1320	1263	15
HMF 125 T4 30kW (A3:4) F400	1000	20x18°	1365	1320	1263	15
HMF 125 T4 30kW (A3:8) F400	1000	20x18°	1365	1320	1263	15
HMF 125 T4 37kW (A3:8) F400	1000	20x18°	1365	1320	1263	15
HMF 125 T4 45kW (A3:8) F400	1000	20x18°	1365	1320	1263	15
HMF 125 T6 3kW (A3:4) F400	1000	20x18°	1365	1320	1263	15
HMF 125 T6 4kW (A3:4) F400	1000	20x18°	1365	1320	1263	15
HMF 125 T6 5,5kW (A3:4) F400	1000	20x18°	1365	1320	1263	15
HMF 125 T6 5,5kW (A3:8) F400	1000	20x18°	1365	1320	1263	15
HMF 125 T6 7,5kW (A3:4) F400	1000	20x18°	1365	1320	1263	15
HMF 125 T6 7,5kW (A3:8) F400	1000	20x18°	1365	1320	1263	15
HMF 125 T6 11kW (A3:8) F400	1000	20x18°	1365	1320	1263	15
HMF 125 T6 15kW (A3:8) F400	1000	20x18°	1365	1320	1263	15
HMF 125 T4/T6 10/3,3kW (A3:4) F400	1000	20x18°	1365	1320	1263	15
HMF 125 T4/T6 14/4,5kW (A3:4) F400	1000	20x18°	1365	1320	1263	15
HMF 125 T4/T6 16/6,5kW (A3:4) F400	1000	20x18°	1365	1320	1263	15

Model	E	O	ØA	ØB	ØDint	ØJ
HMF 125 T4/T6 20/8,5kW (A3:4) F400	1000	20x18°	1365	1320	1263	15
HMF 125 T4/T6 20/8,5kW (A3:8) F400	1000	20x18°	1365	1320	1263	15
HMF 125 T4/T6 26/9kW (A3:4) F400	1000	20x18°	1365	1320	1263	15
HMF 125 T4/T6 26/9kW (A3:8) F400	1000	20x18°	1365	1320	1263	15
HMF 125 T4/T6 34/12kW (A3:4) F400	1000	20x18°	1365	1320	1263	15
HMF 125 T4/T6 34/12kW (A3:8) F400	1000	20x18°	1365	1320	1263	15
HMF 125 T4/T6 40/14kW (A3:8) F400	1000	20x18°	1365	1320	1263	15
HMF 125 T4/T8 11/3kW (A3:4) F400	1000	20x18°	1365	1320	1263	15
HMF 125 T4/T8 14/3,5kW (A3:4) F400	1000	20x18°	1365	1320	1263	15
HMF 125 T4/T8 17/4,3kW (A3:4) F400	1000	20x18°	1365	1320	1263	15
HMF 125 T4/T8 20/5kW (A3:4) F400	1000	20x18°	1365	1320	1263	15
HMF 125 T4/T8 20/5kW (A3:8) F400	1000	20x18°	1365	1320	1263	15
HMF 125 T4/T8 28/6,5kW (A3:4) F400	1000	20x18°	1365	1320	1263	15
HMF 125 T4/T8 28/6,5kW (A3:8) F400	1000	20x18°	1365	1320	1263	15
HMF 125 T4/T8 37/9,2kW (A3:8) F400	1000	20x18°	1365	1320	1263	15
HMF 125 T4/T8 44/11kW (A3:8) F400	1000	20x18°	1365	1320	1263	15

Wiring diagram

DIAGRAM Nº 1

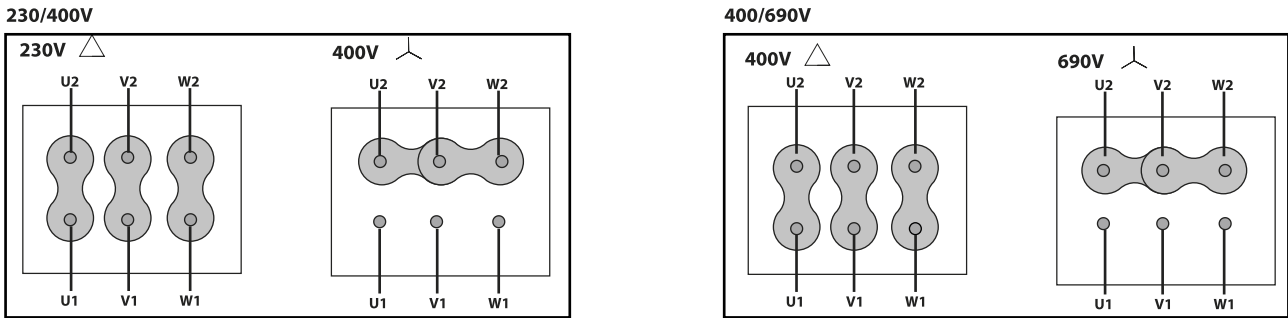

DIAGRAM Nº 2

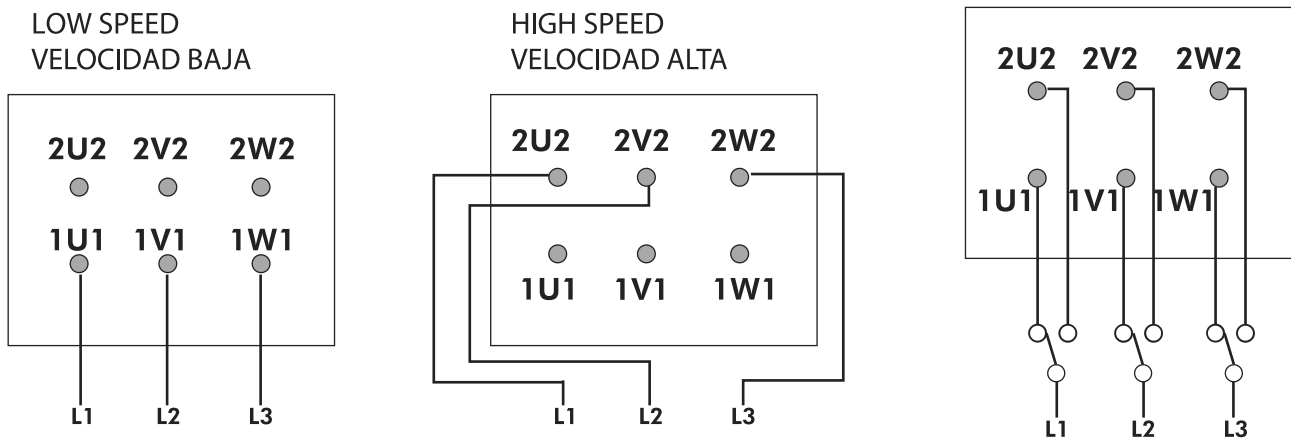
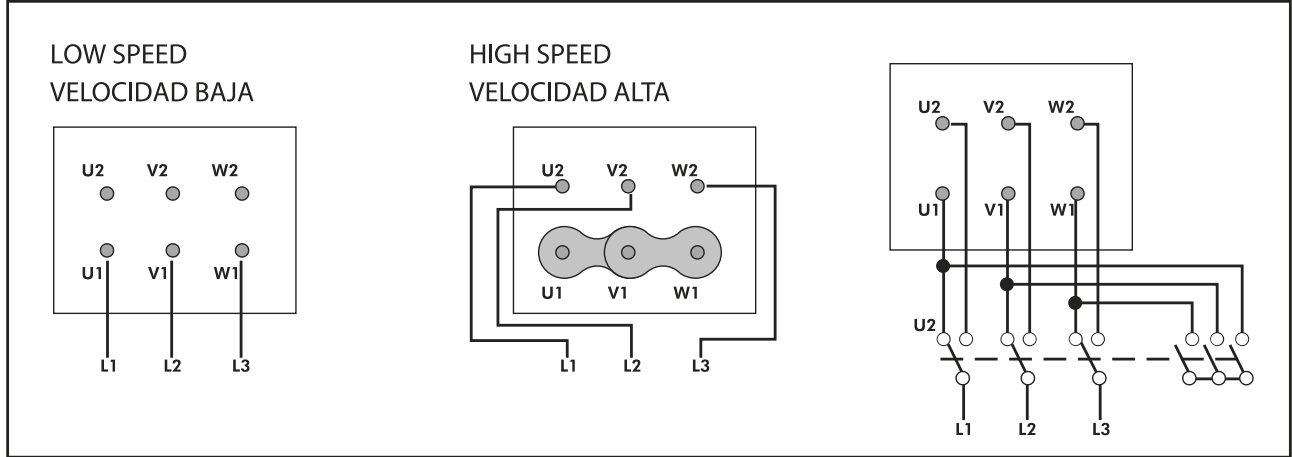

DIAGRAM Nº 3

400V DAHLANDER (Y,YY)



CHARACTERISCTIC CURVE

HMF 45 T4 0,75kW (A5:6) F400

AIR FLOW - PRESSURE

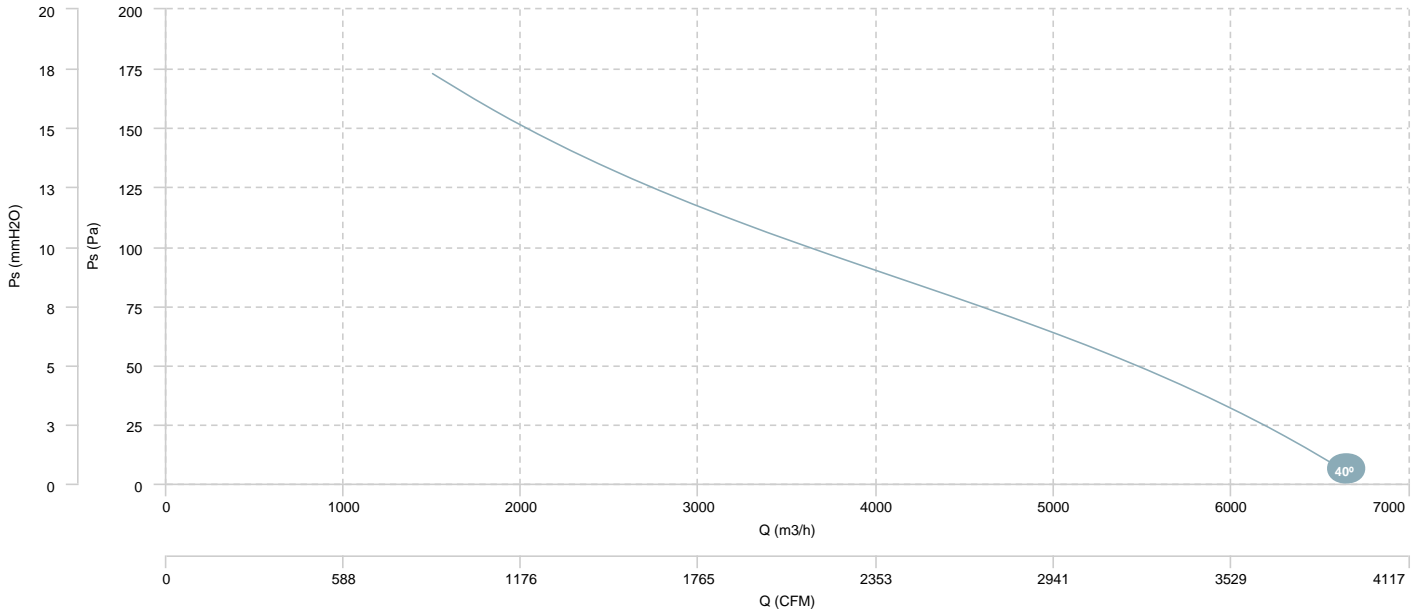

AIR FLOW - ABSORBED POWER

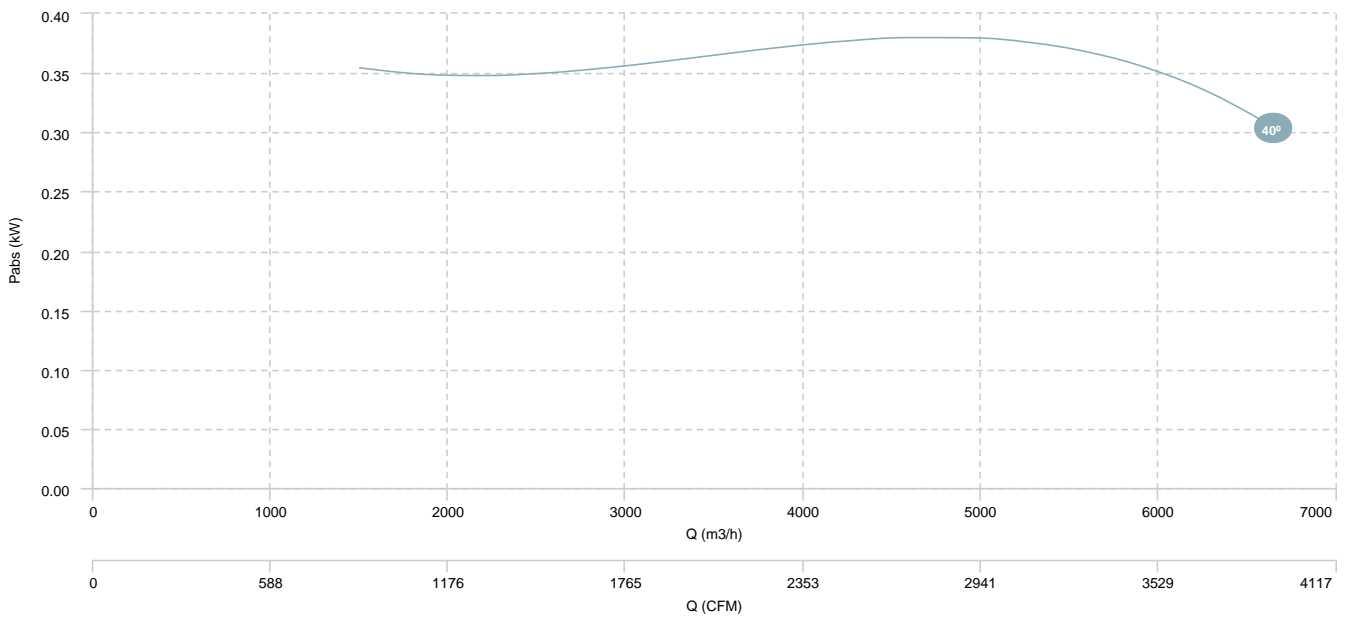

HMF 45 T4/T6 0,75/0,25kW (A5:6) F400

AIR FLOW - PRESSURE (4 poles)

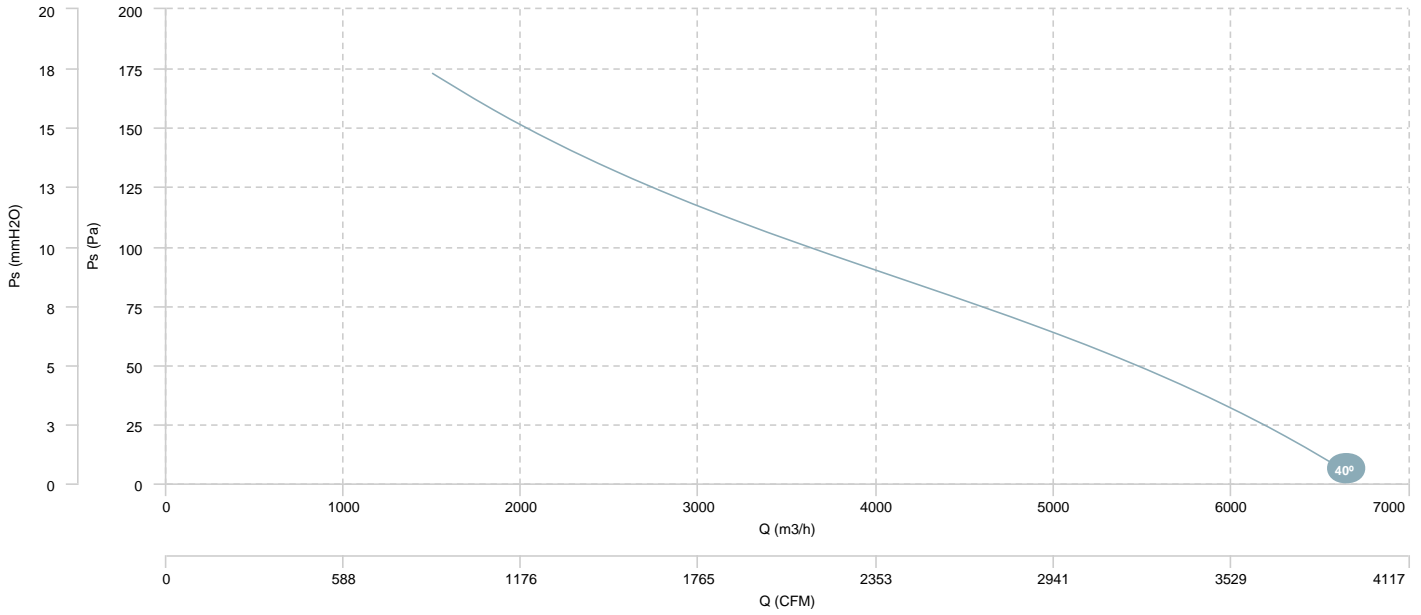

AIR FLOW - ABSORBED POWER (4 poles)

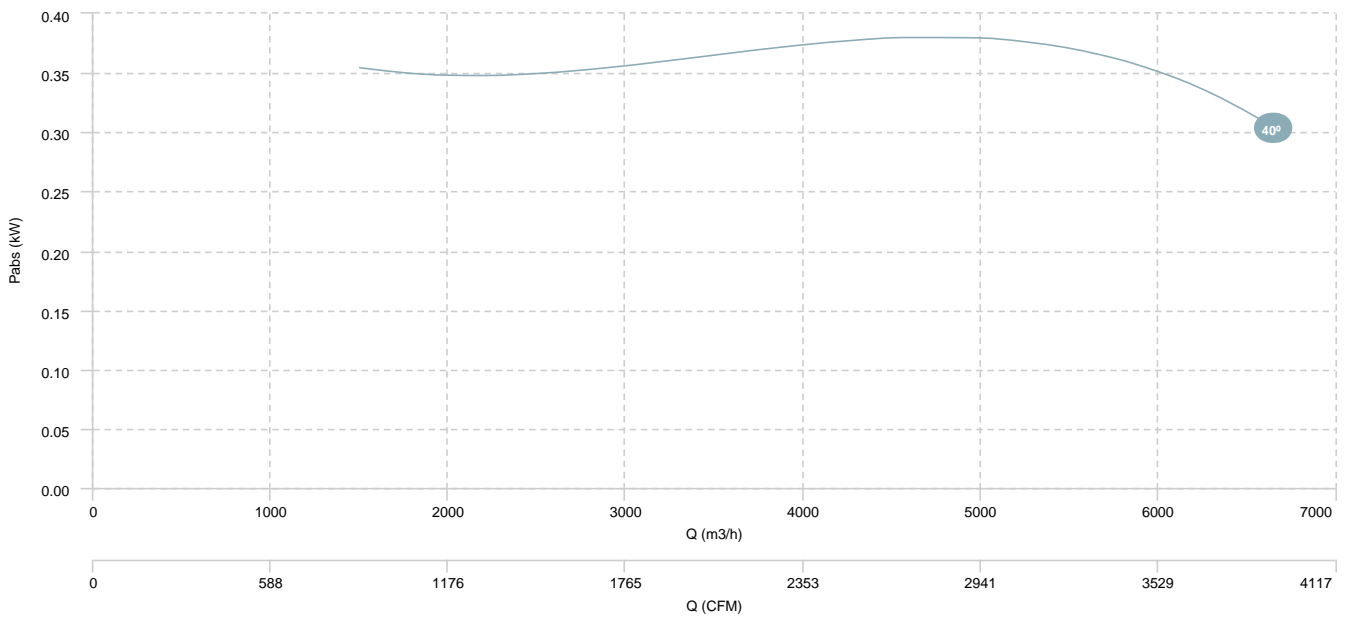

HMF 45 T4/T6 0,75/0,25kW (A5:6) F400

AIR FLOW - PRESSURE (6 poles)

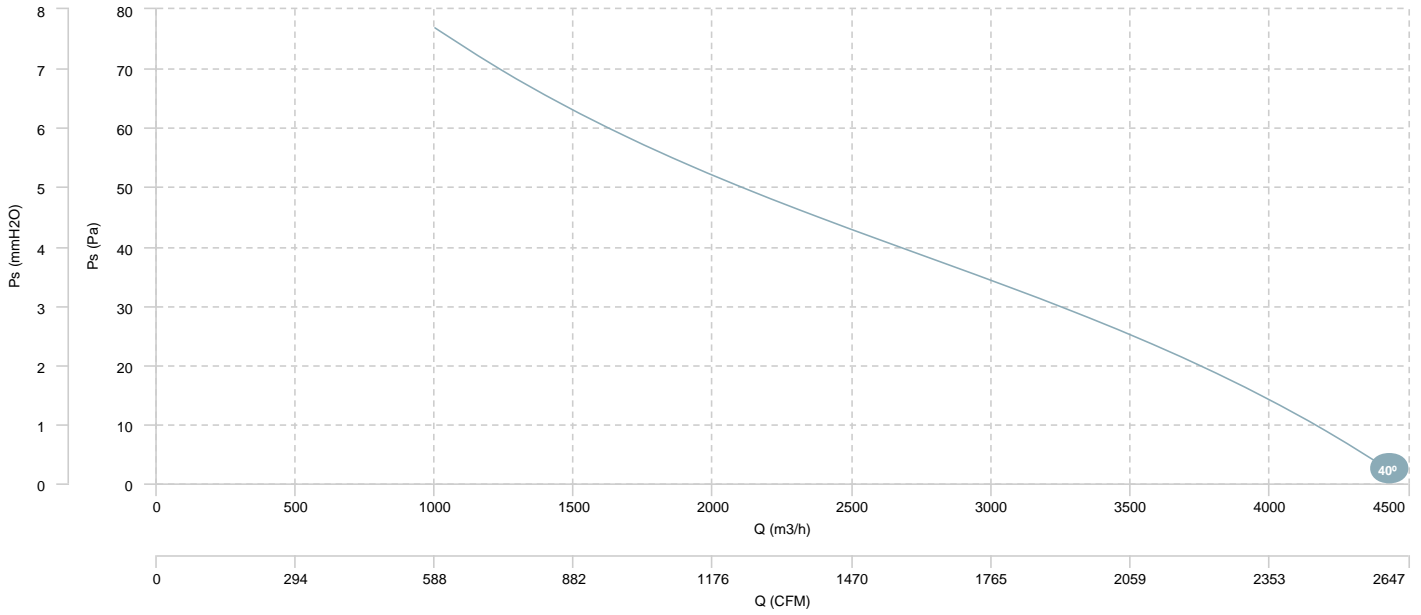

HMF 45 T4/T8 0,8/0,2kW (A5:6) F400

AIR FLOW - PRESSURE (4 poles)

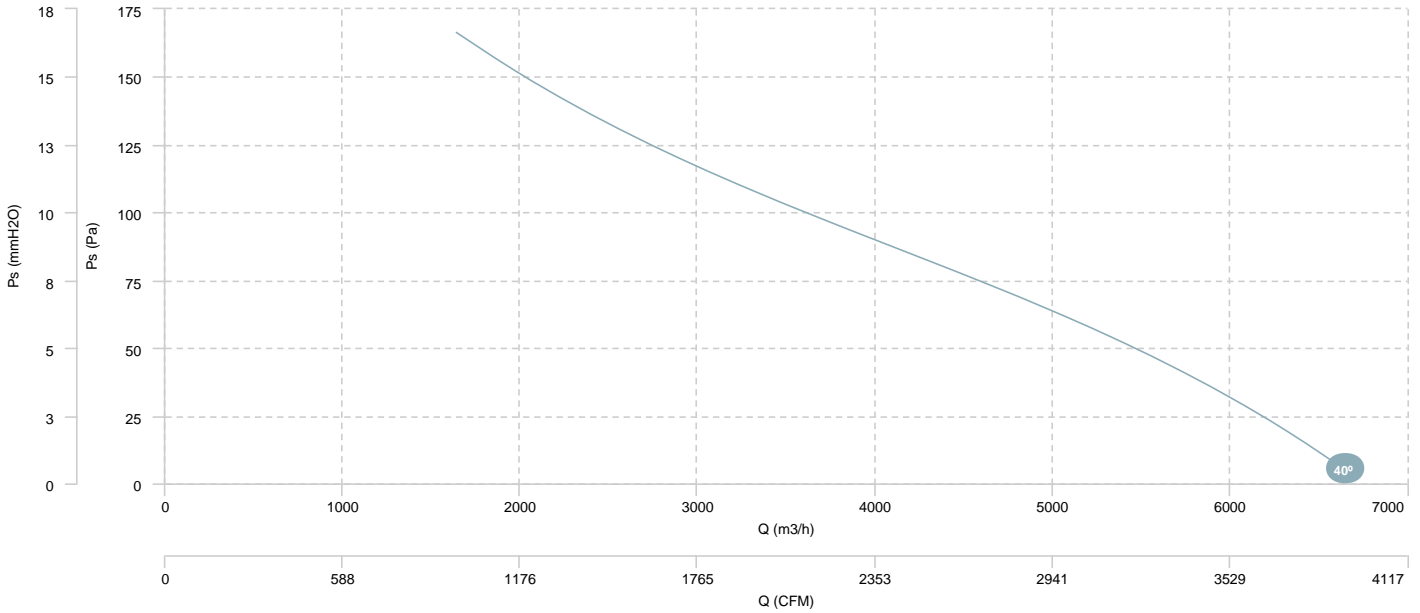

AIR FLOW - ABSORBED POWER (4 poles)

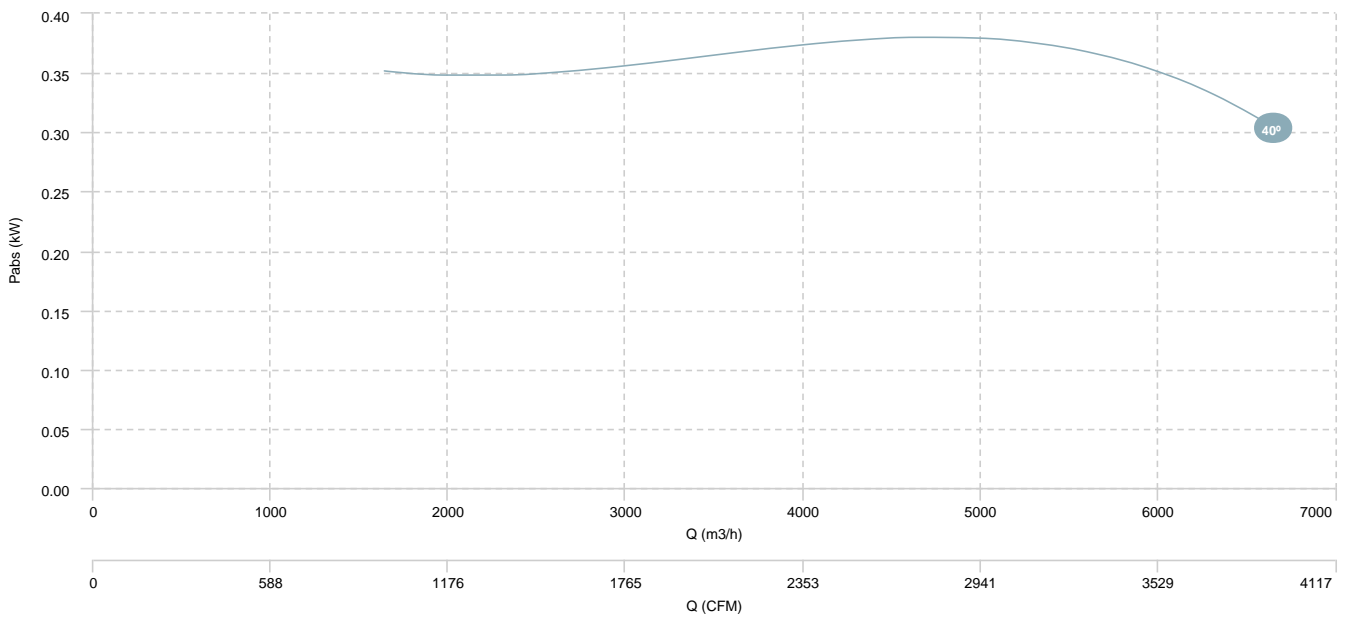

HMF 45 T4/T8 0,8/0,2kW (A5:6) F400

AIR FLOW - PRESSURE (8 poles)

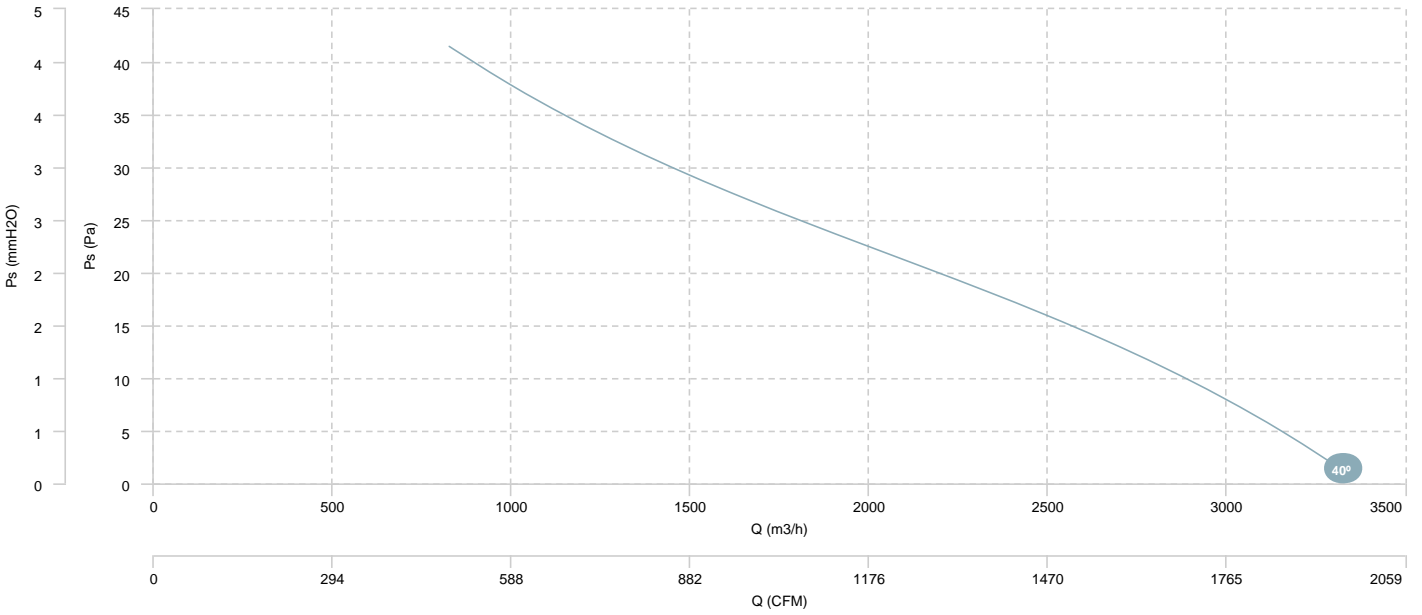

HMF 50 T4 0,75kW (A5:6) F400

AIR FLOW - PRESSURE

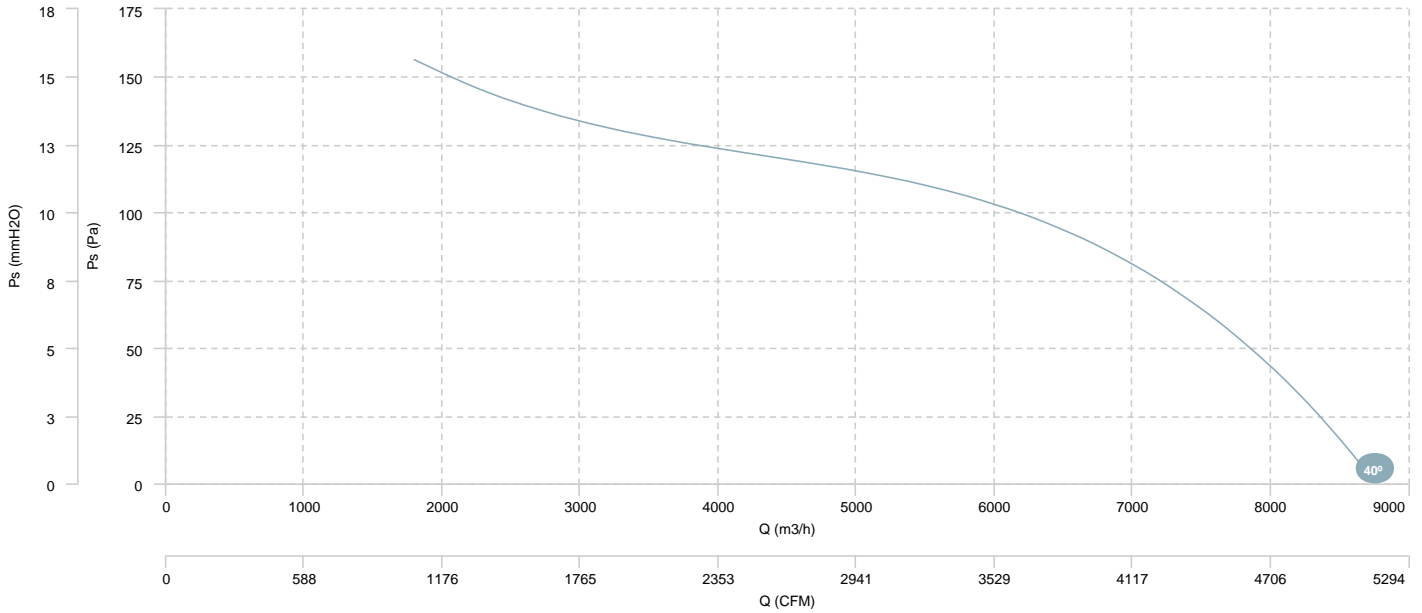

AIR FLOW - ABSORBED POWER

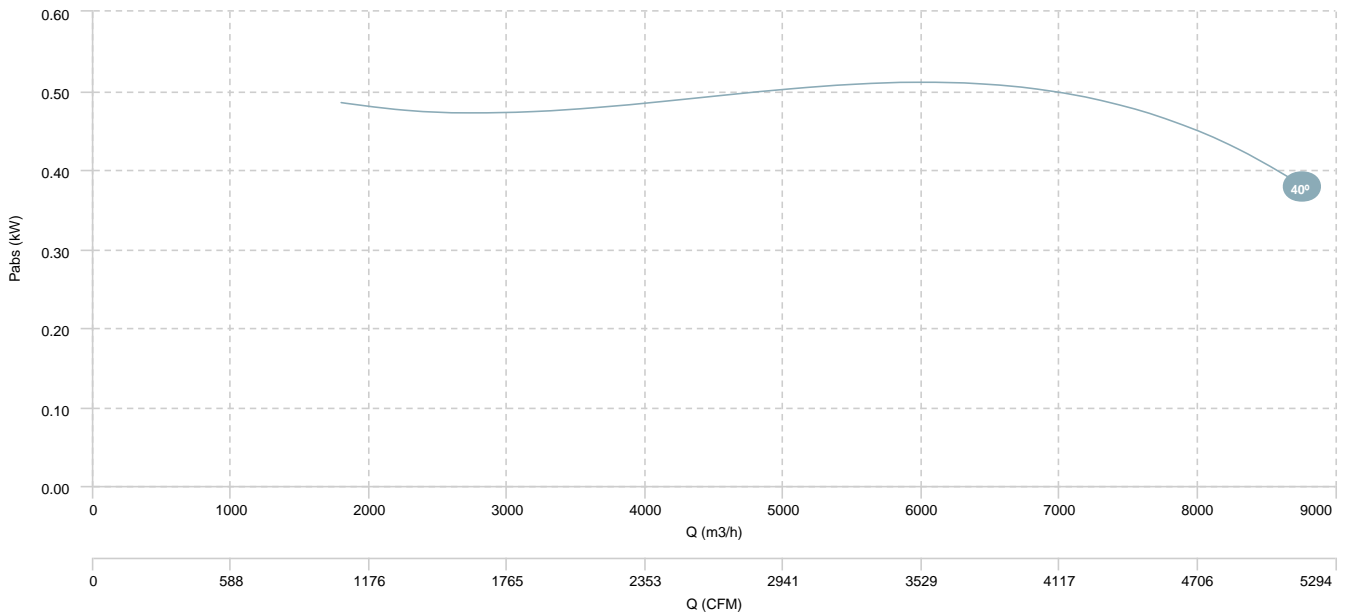

HMF 50 T6 0,75kW (A5:6) F400

AIR FLOW - PRESSURE

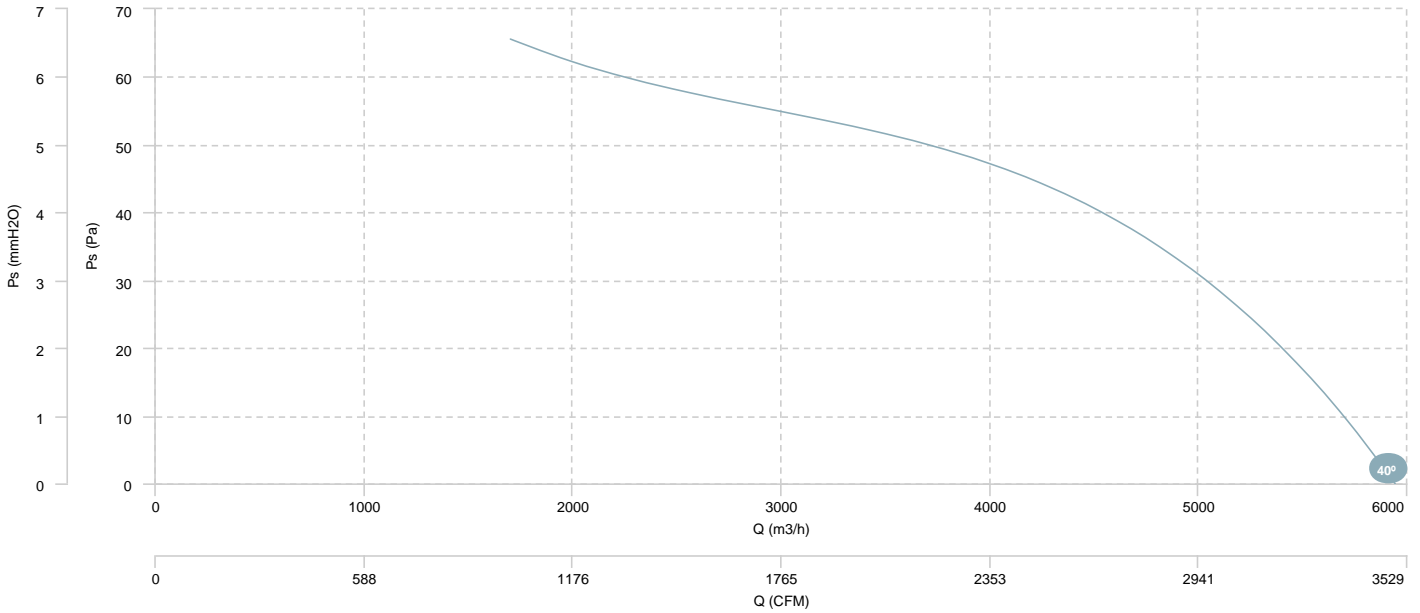

AIR FLOW - ABSORBED POWER

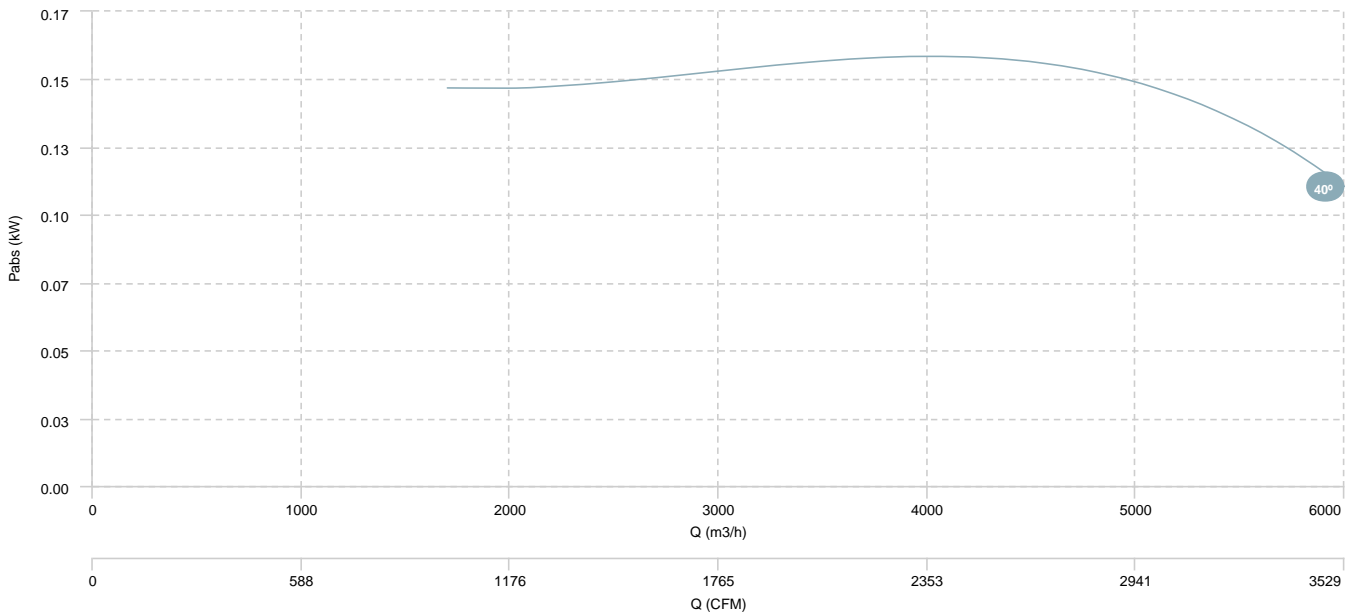

HMF 50 T4/T6 0,75/0,25kW (A5:6) F400

AIR FLOW - PRESSURE (4 poles)

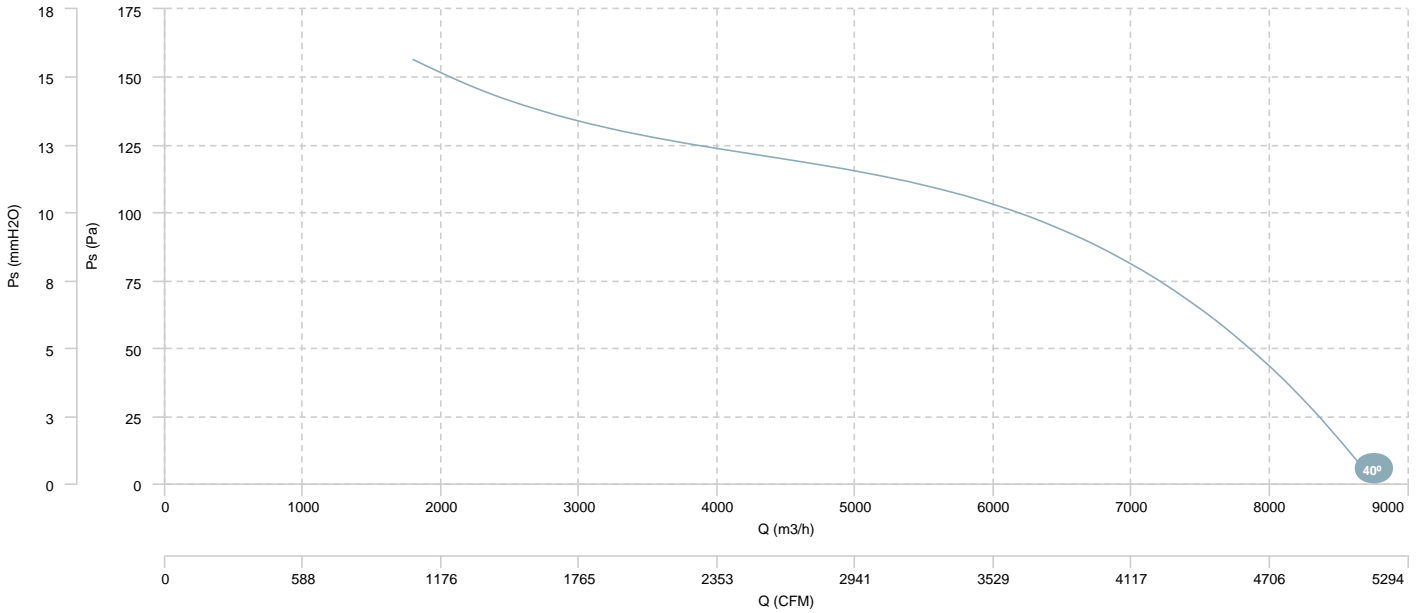

AIR FLOW - ABSORBED POWER (4 poles)

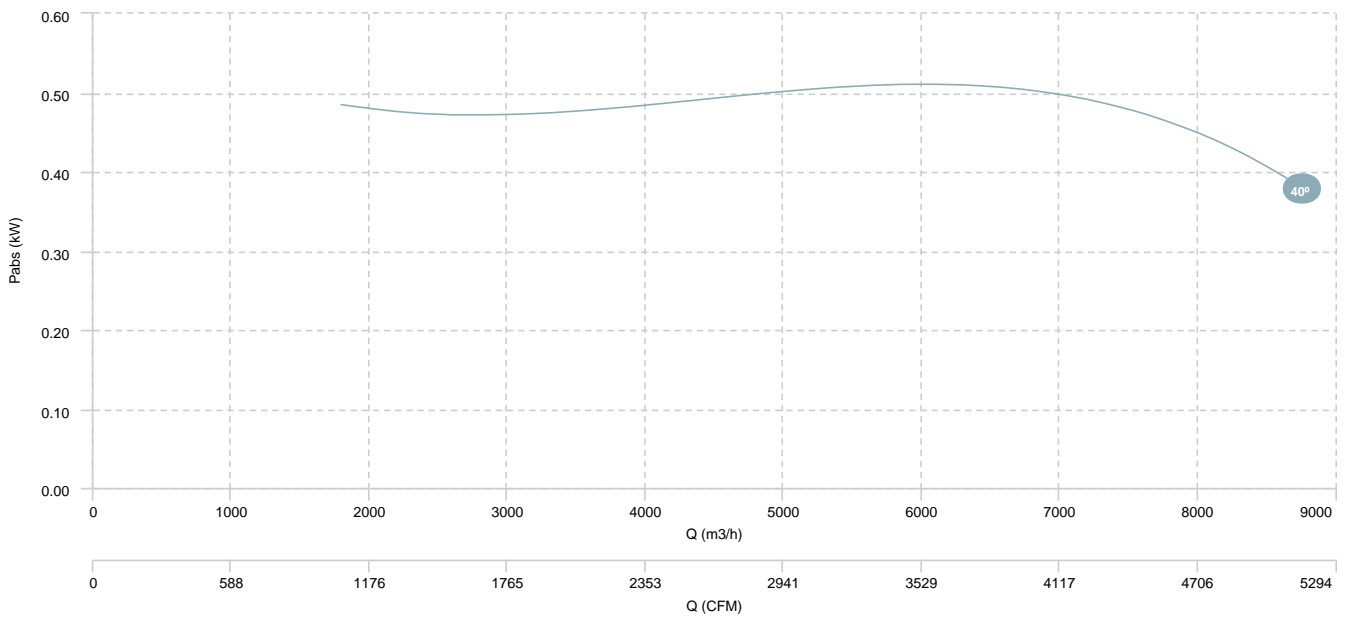

HMF 50 T4/T6 0,75/0,25kW (A5:6) F400

AIR FLOW - PRESSURE (6 poles)

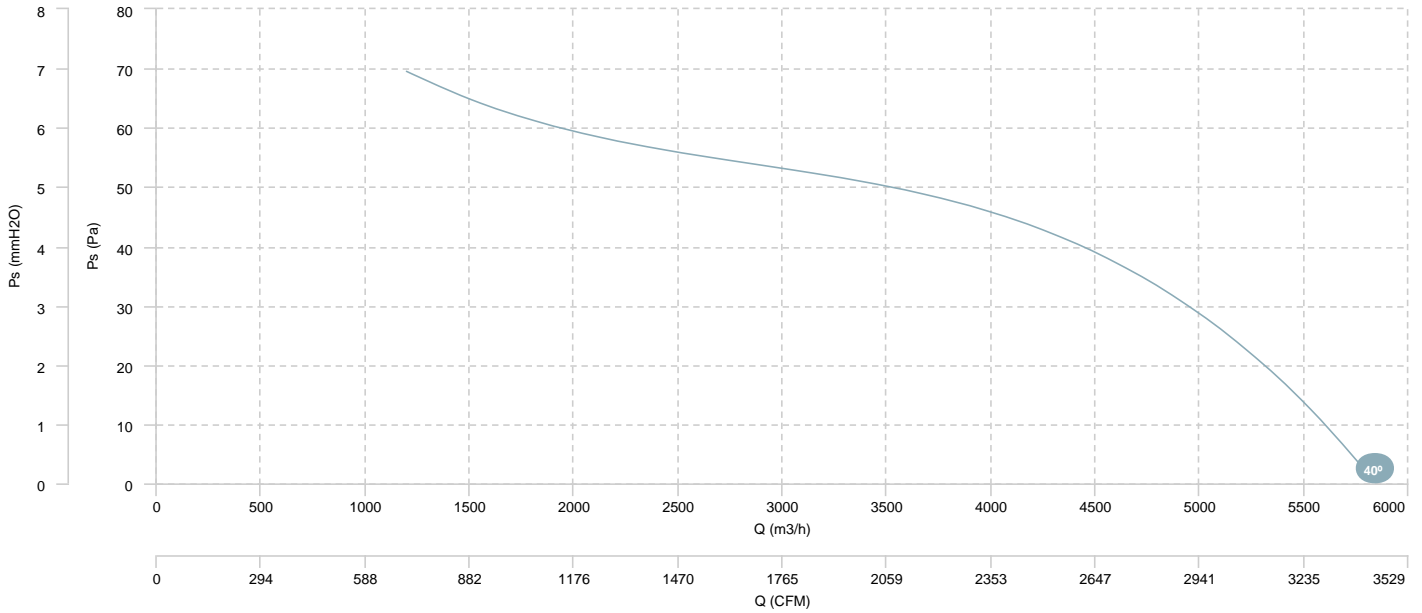

HMF 50 T4/T8 0,8/0,2kW (A5:6) F400

AIR FLOW - PRESSURE (4 poles)

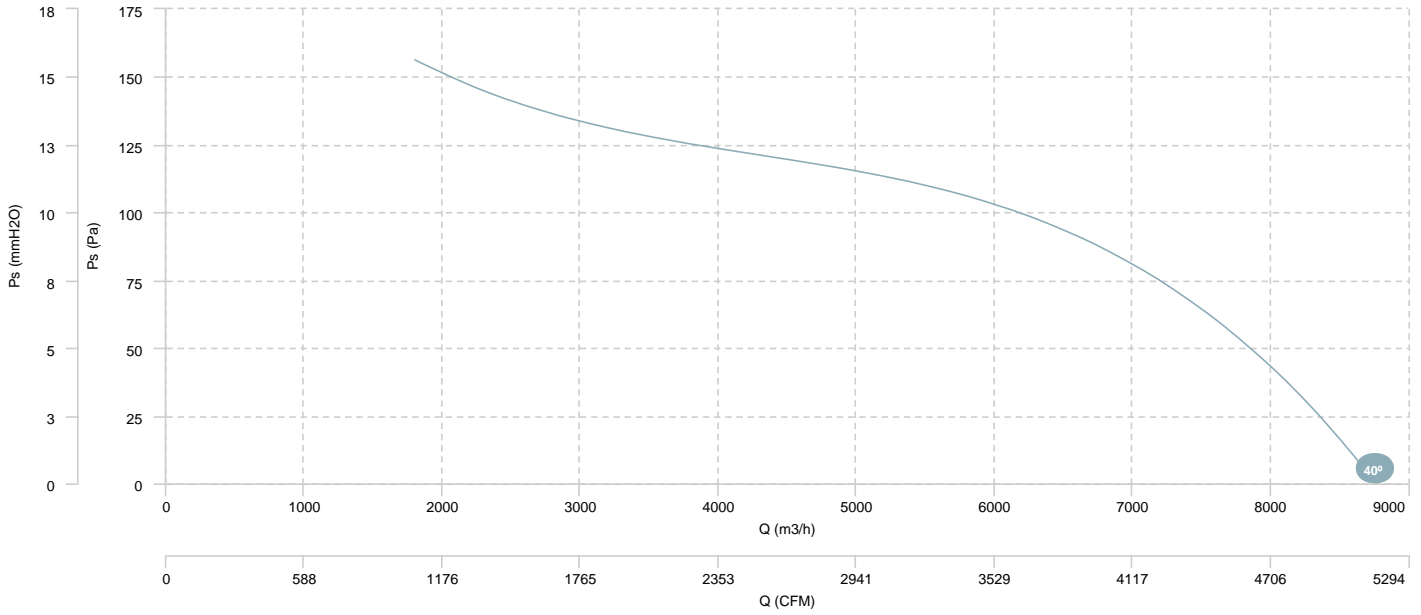

AIR FLOW - ABSORBED POWER (4 poles)

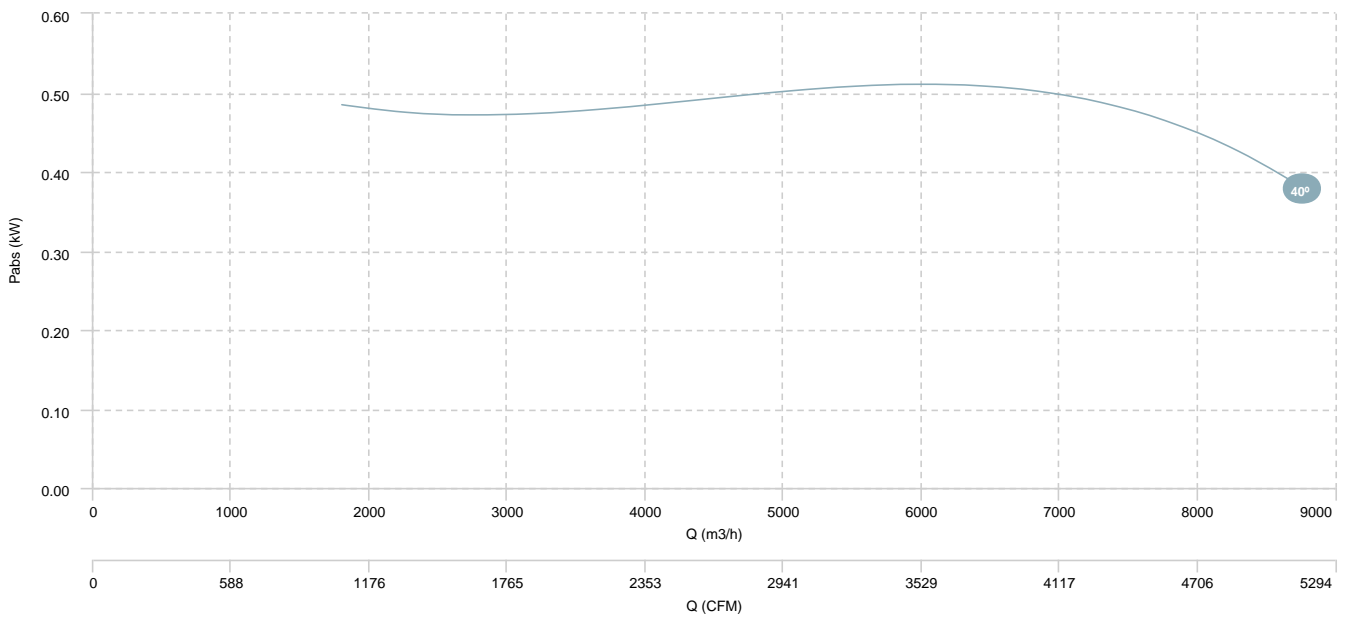

HMF 50 T4/T8 0,8/0,2kW (A5:6) F400

AIR FLOW - PRESSURE (8 poles)

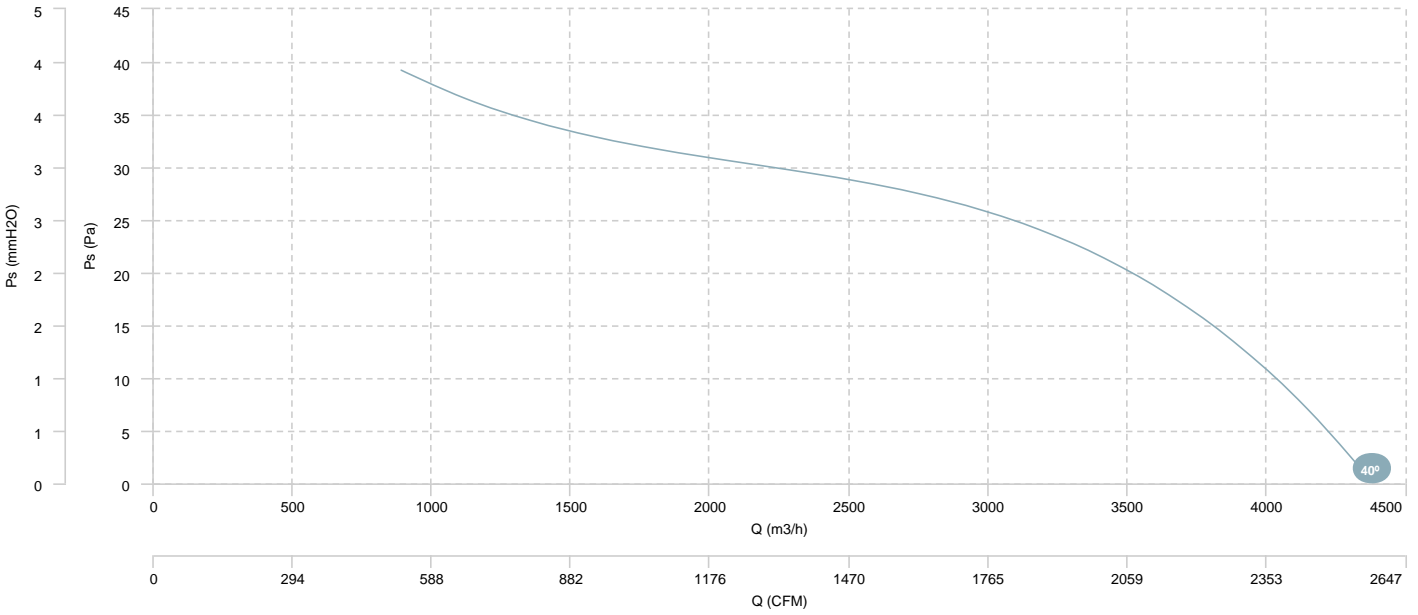

HMF 56 T4 0,75kW (A5:6) F400

HMF 56 T4 1,1kW (A5:6) F400

HMF 56 T4 1,5kW (A5:6) F400

AIR FLOW - PRESSURE

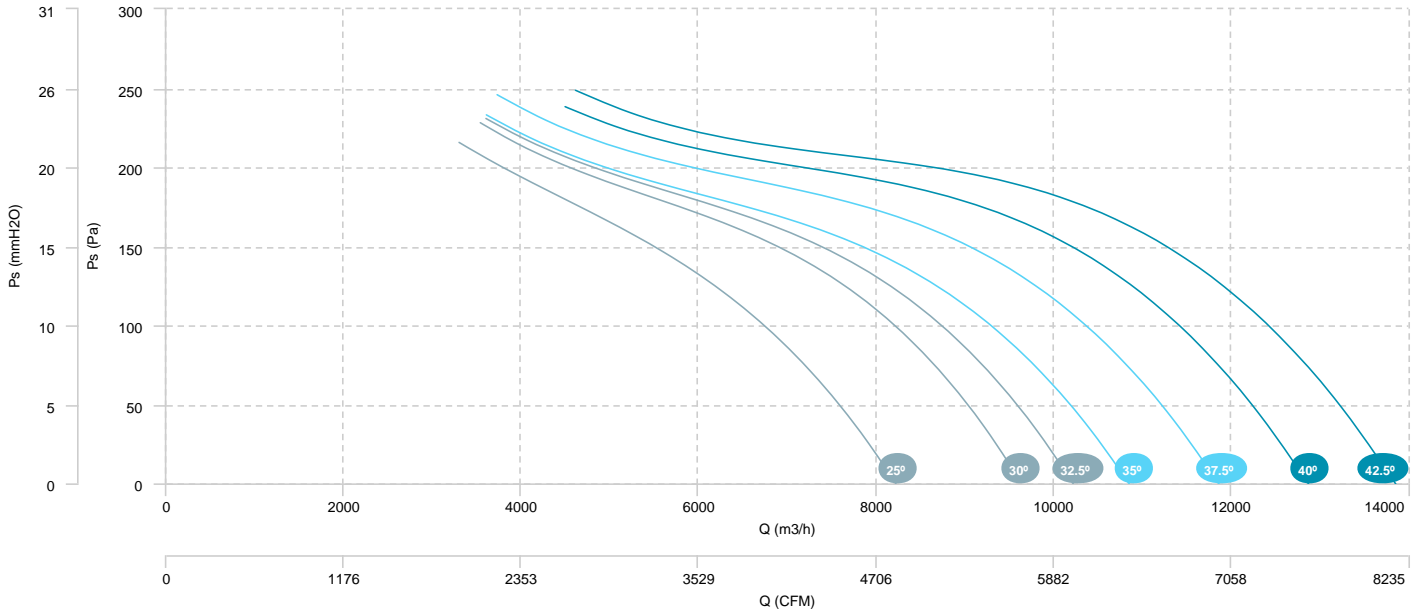

AIR FLOW - ABSORBED POWER

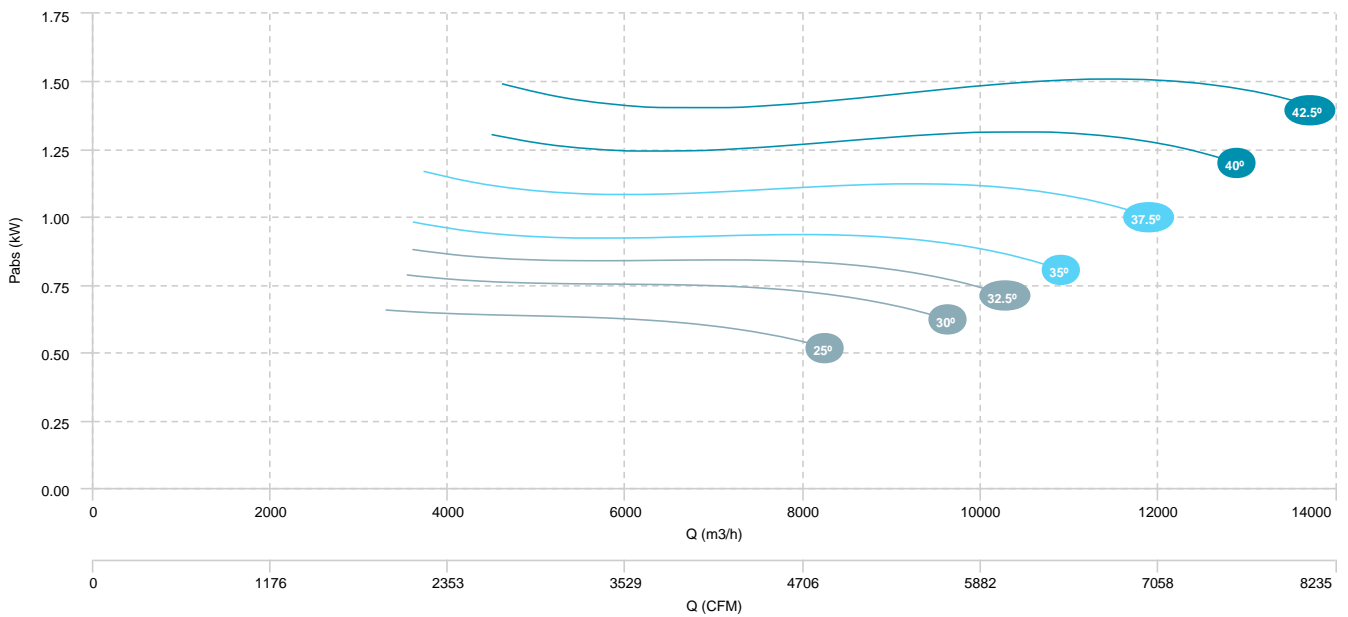

HMF 56 T6 0,75kW (A5:6) F400

AIR FLOW - PRESSURE

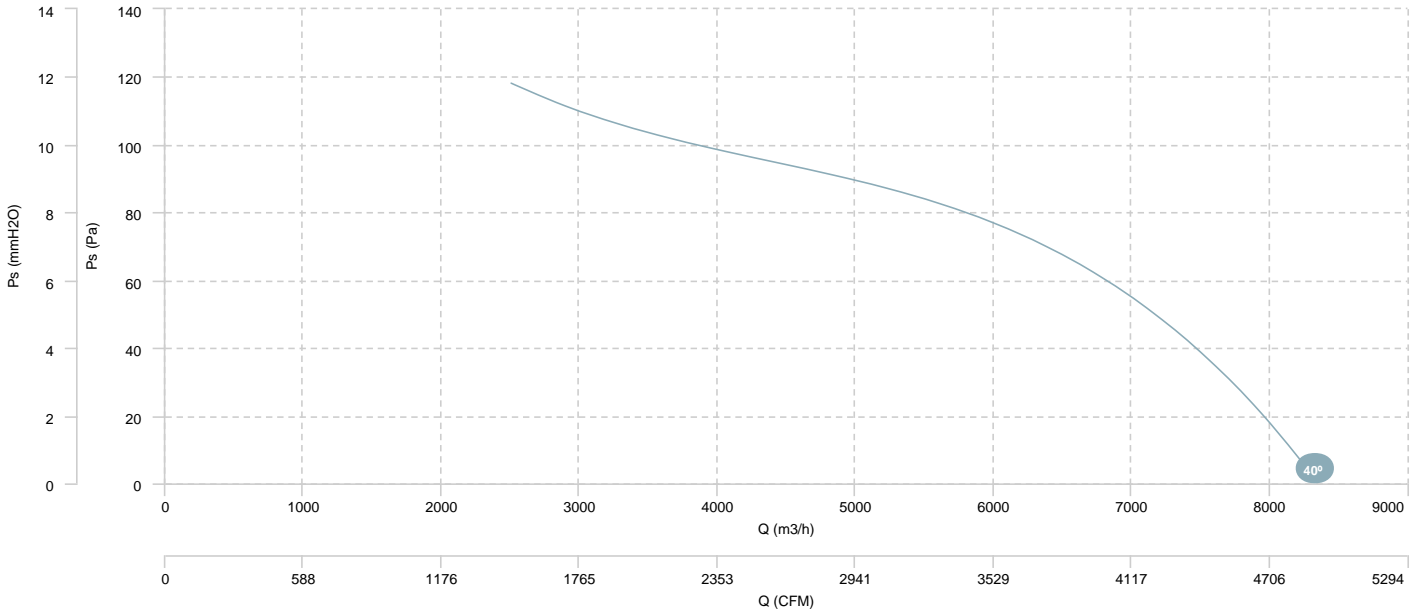

AIR FLOW - ABSORBED POWER

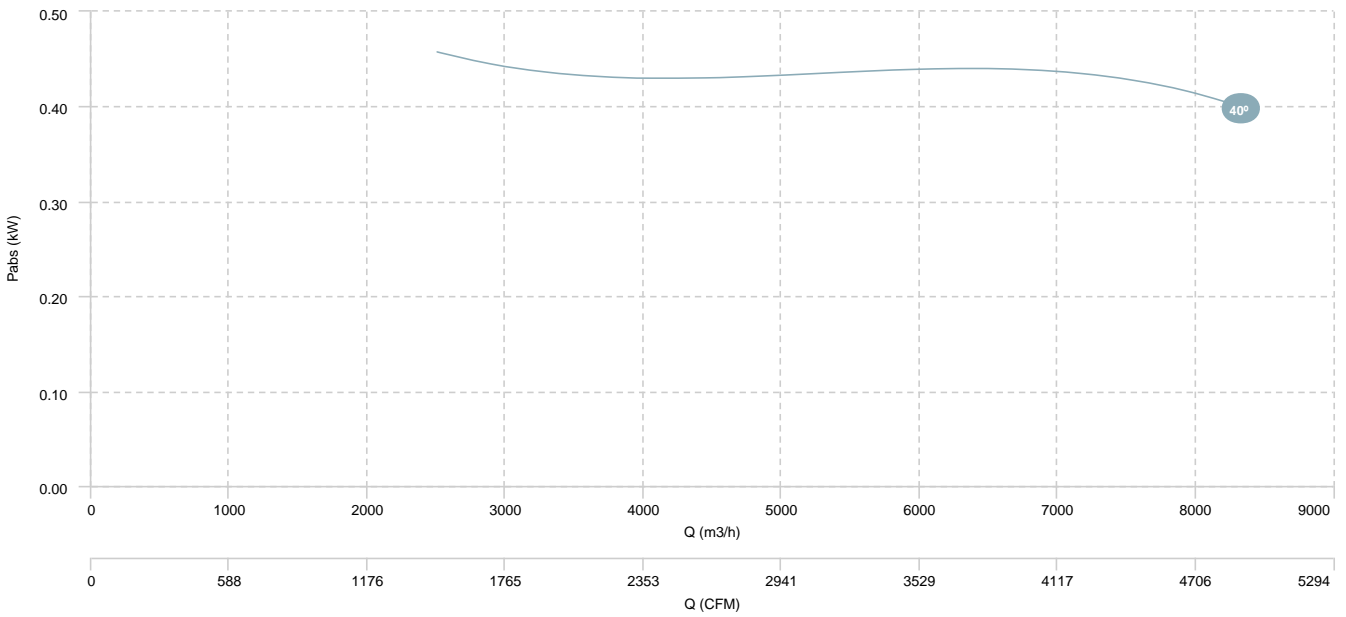

HMF 56 T4/T6 0,75/0,25kW (A5:6) F400

HMF 56 T4/T6 1,1/0,3kW (A5:6) F400

HMF 56 T4/T6 1,5/0,37kW (A5:6) F400

AIR FLOW - PRESSURE (4 poles)

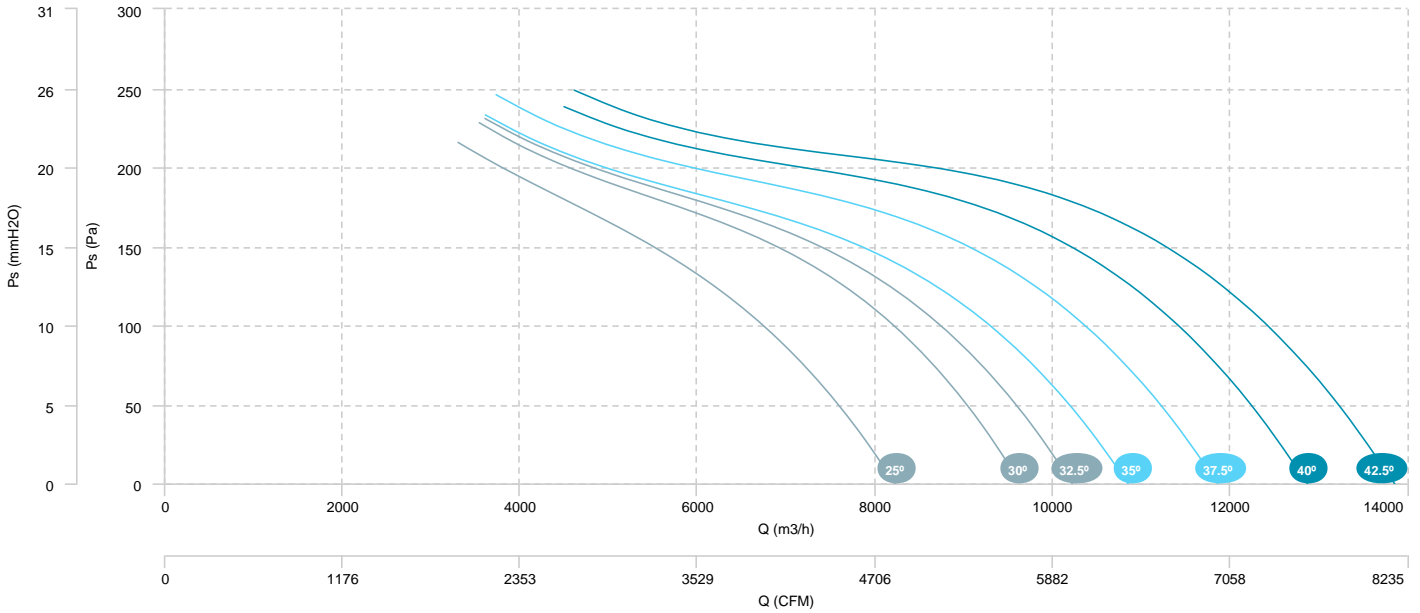

AIR FLOW - ABSORBED POWER (4 poles)

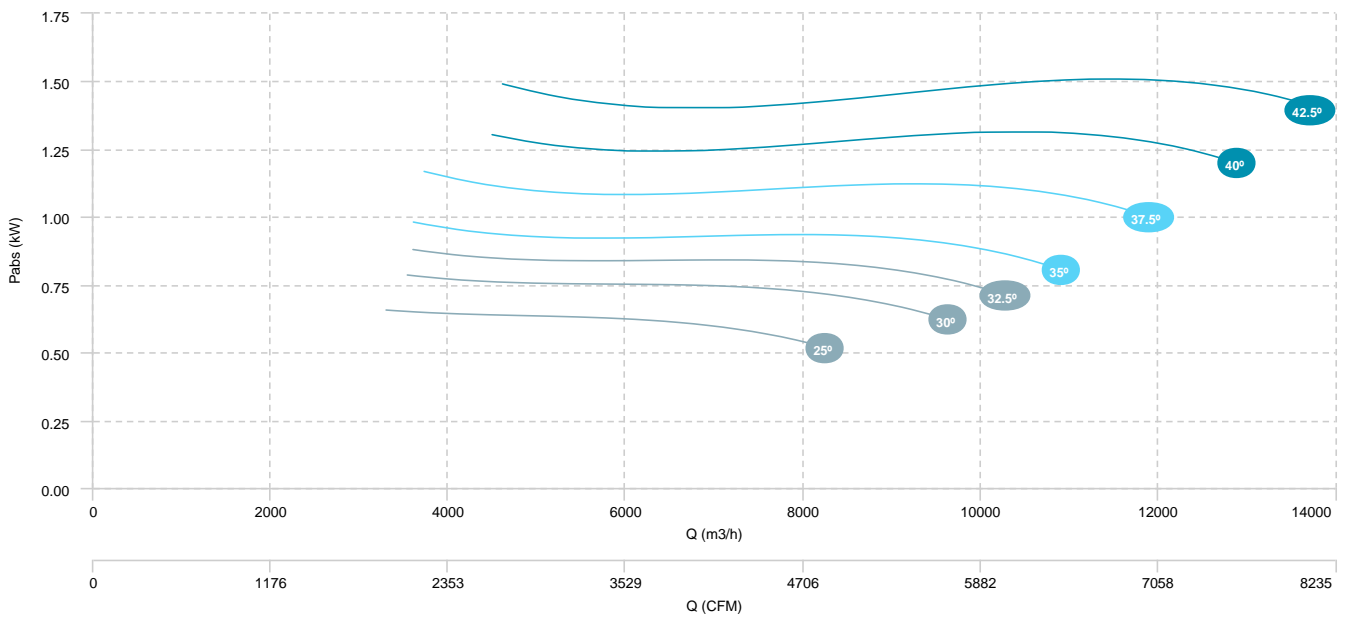

HMF 56 T4/T6 0,75/0,25kW (A5:6) F400

HMF 56 T4/T6 1,1/0,3kW (A5:6) F400

HMF 56 T4/T6 1,5/0,37kW (A5:6) F400

AIR FLOW - PRESSURE (6 poles)

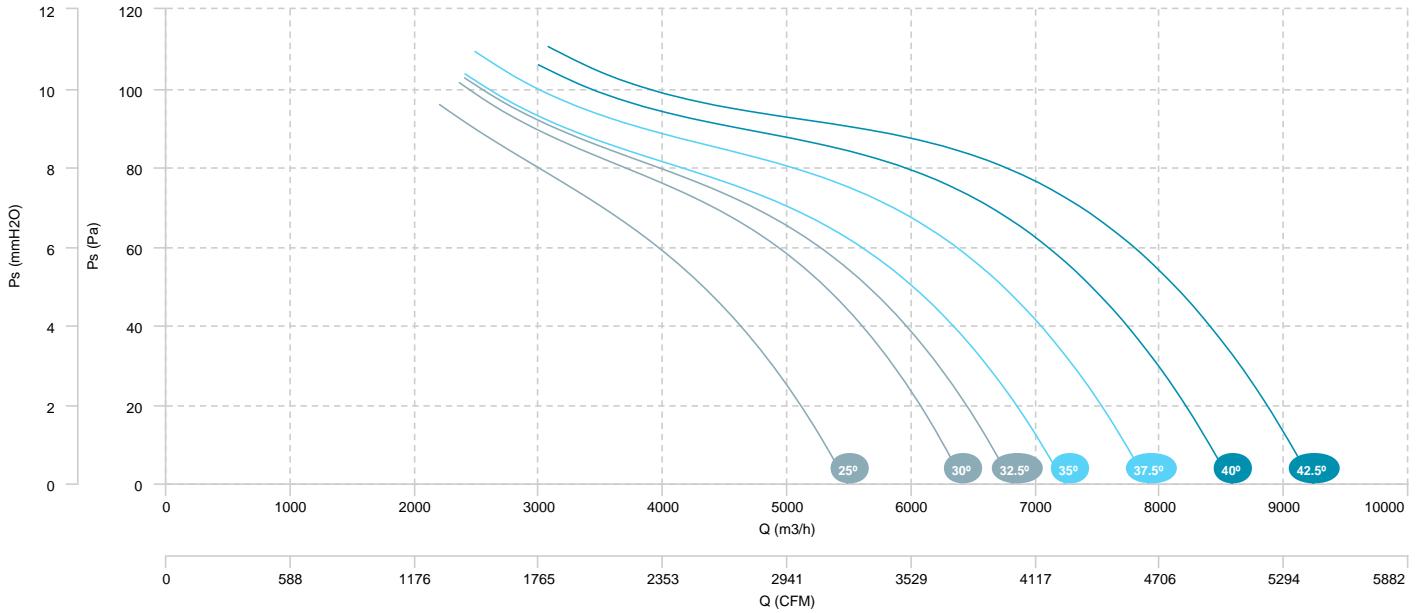

HMF 56 T4/T8 0,8/0,2kW (A5:6) F400

HMF 56 T4/T8 1,2/0,3kW (A5:6) F400

HMF 56 T4/T8 1,6/0,4kW (A5:6) F400

AIR FLOW - PRESSURE (4 poles)

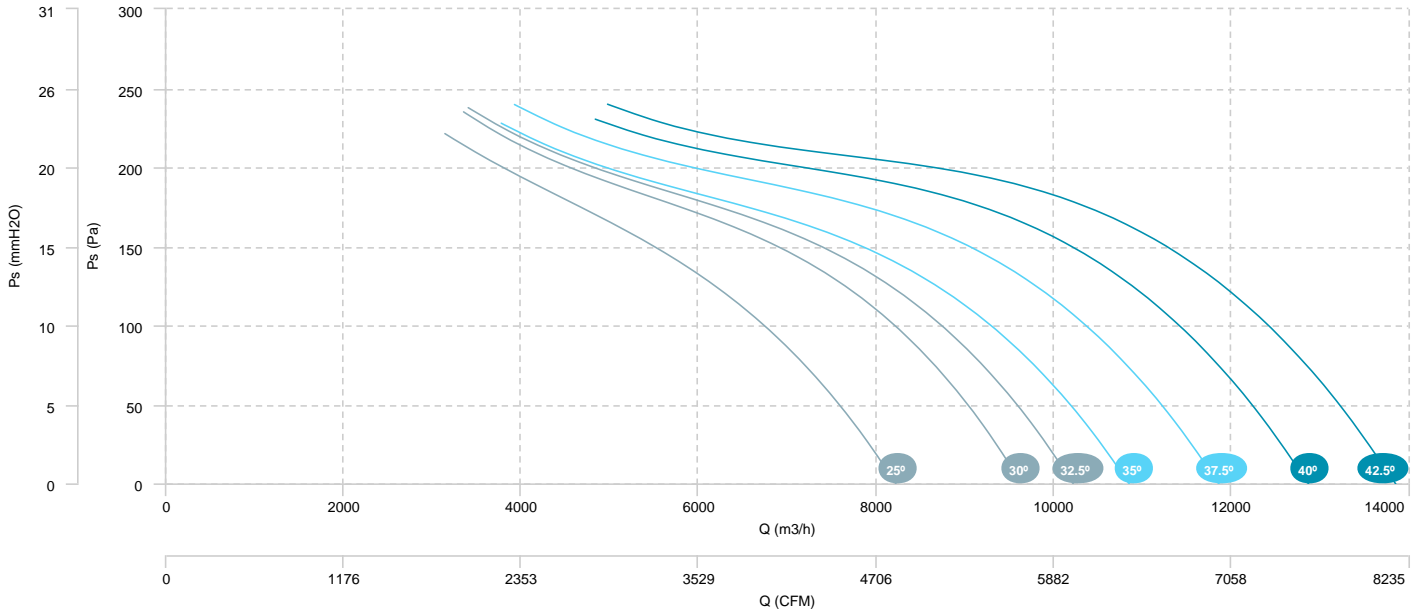

AIR FLOW - ABSORBED POWER (4 poles)

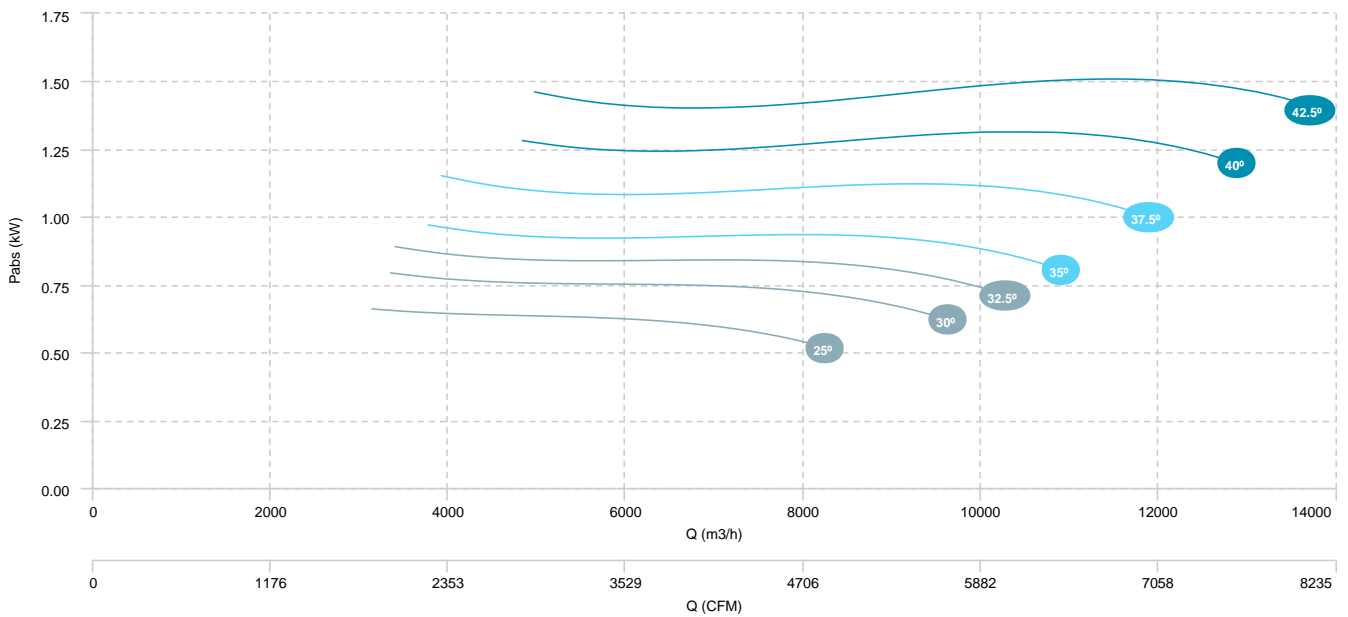

HMF 56 T4/T8 0,8/0,2kW (A5:6) F400

HMF 56 T4/T8 1,2/0,3kW (A5:6) F400

HMF 56 T4/T8 1,6/0,4kW (A5:6) F400

AIR FLOW - PRESSURE (8 poles)

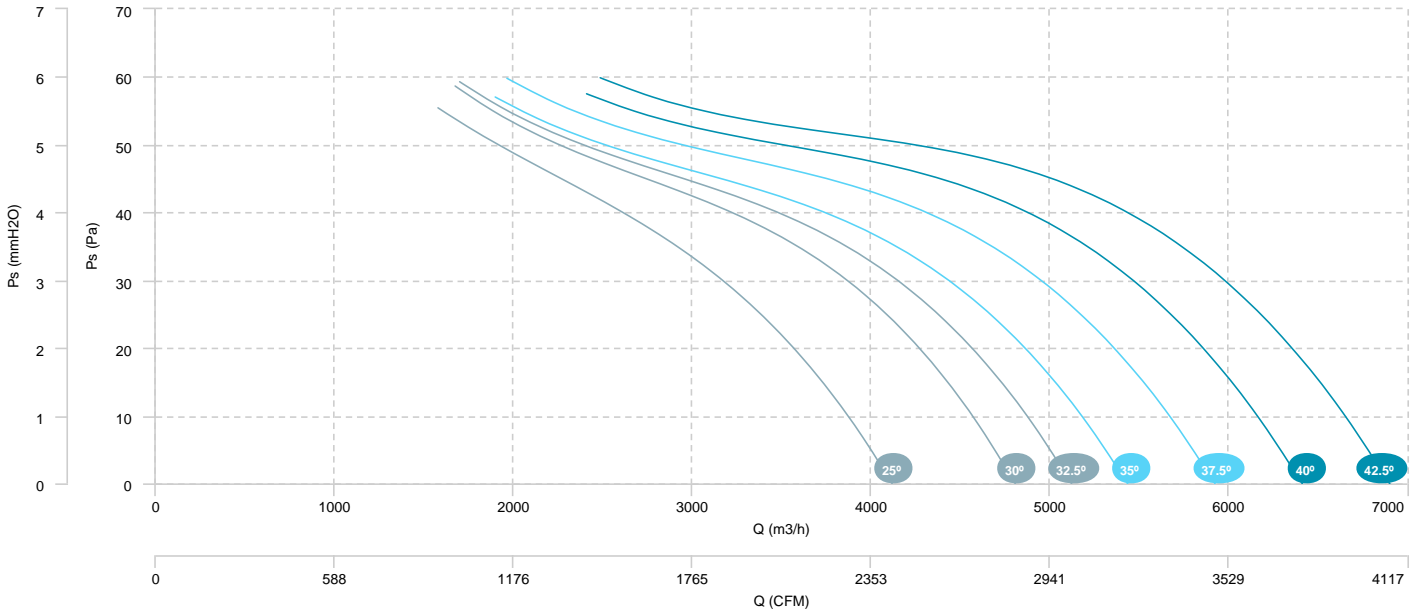

HMF 63 T4 0,75kW (A5:6) F400	HMF 63 T4 1,1kW (A5:6) F400	HMF 63 T4 1,5kW (A5:6) F400
HMF 63 T4 2,2kW (A5:6) F400		

AIR FLOW - PRESSURE

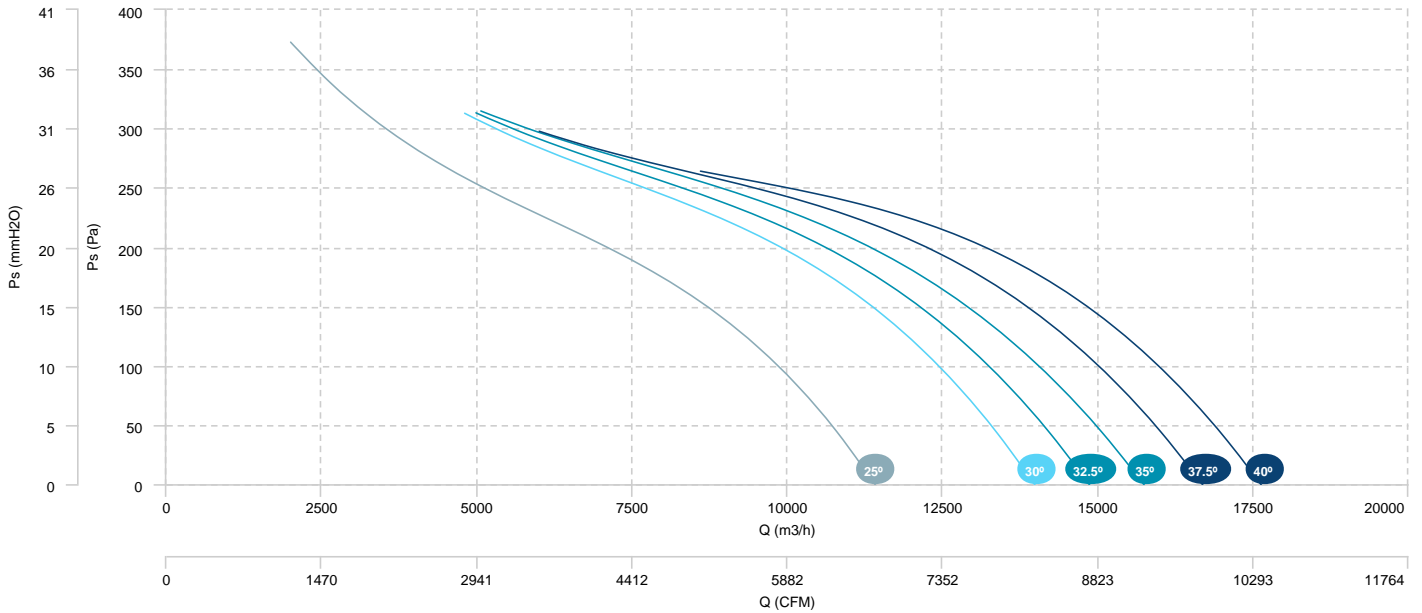

AIR FLOW - ABSORBED POWER

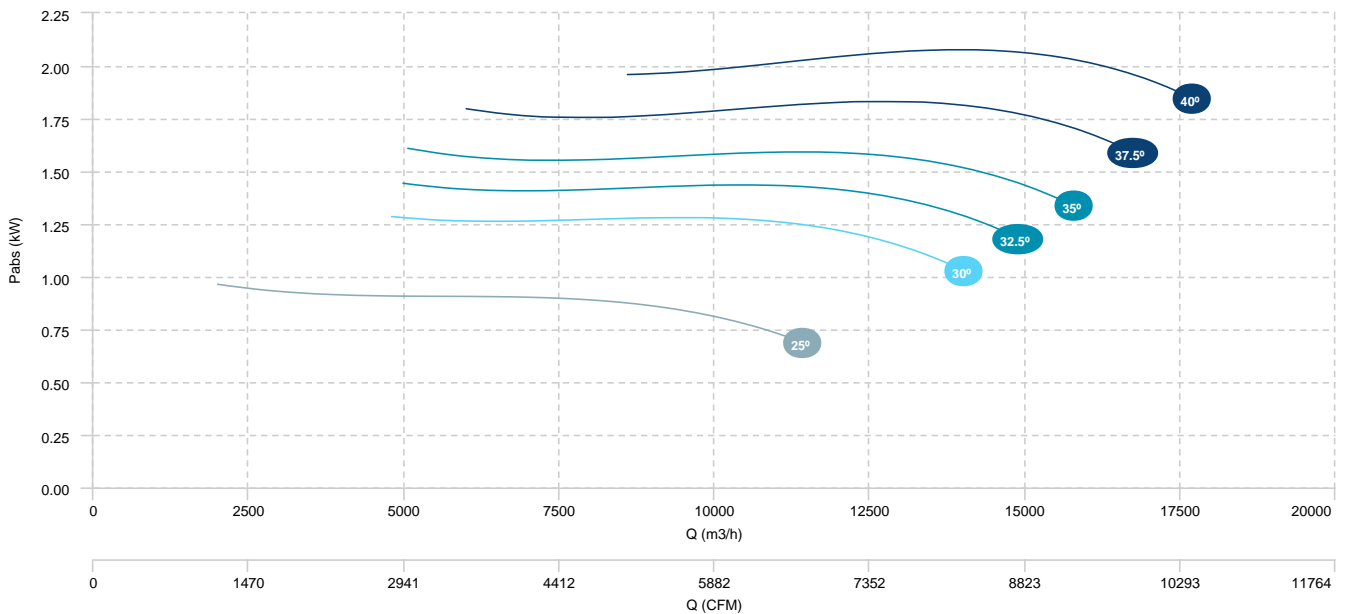

HMF 63 T6 0,75kW (A5:6) F400

AIR FLOW - PRESSURE

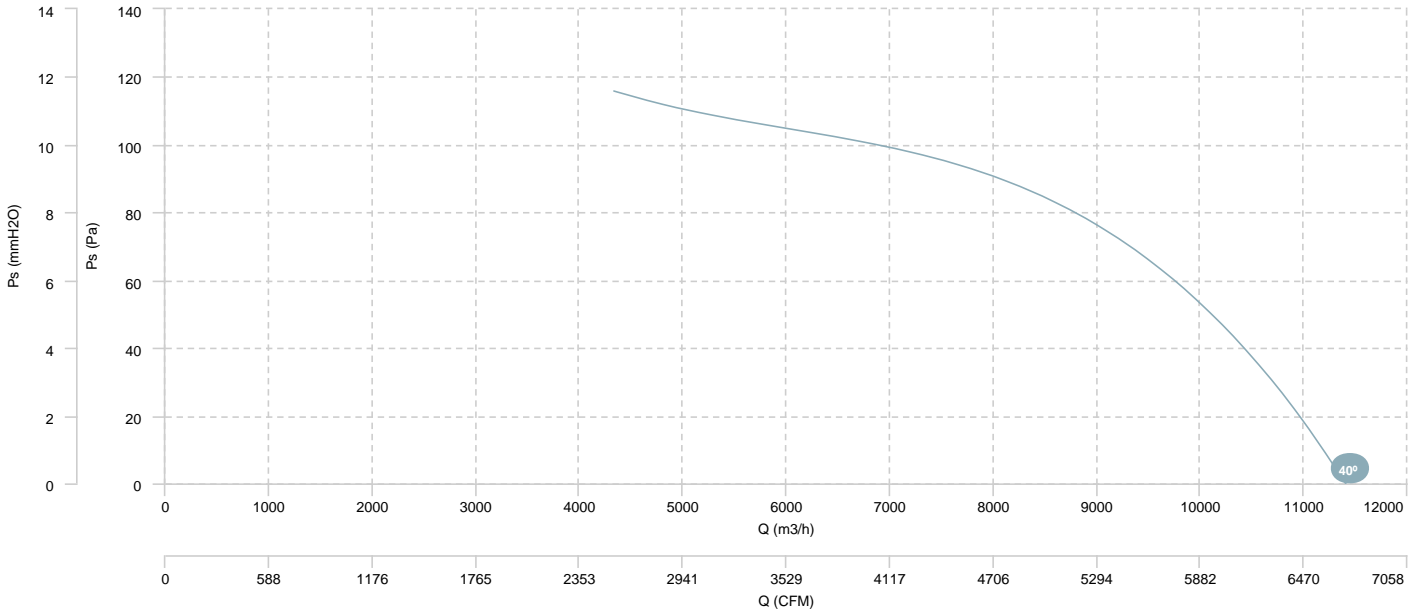

AIR FLOW - ABSORBED POWER

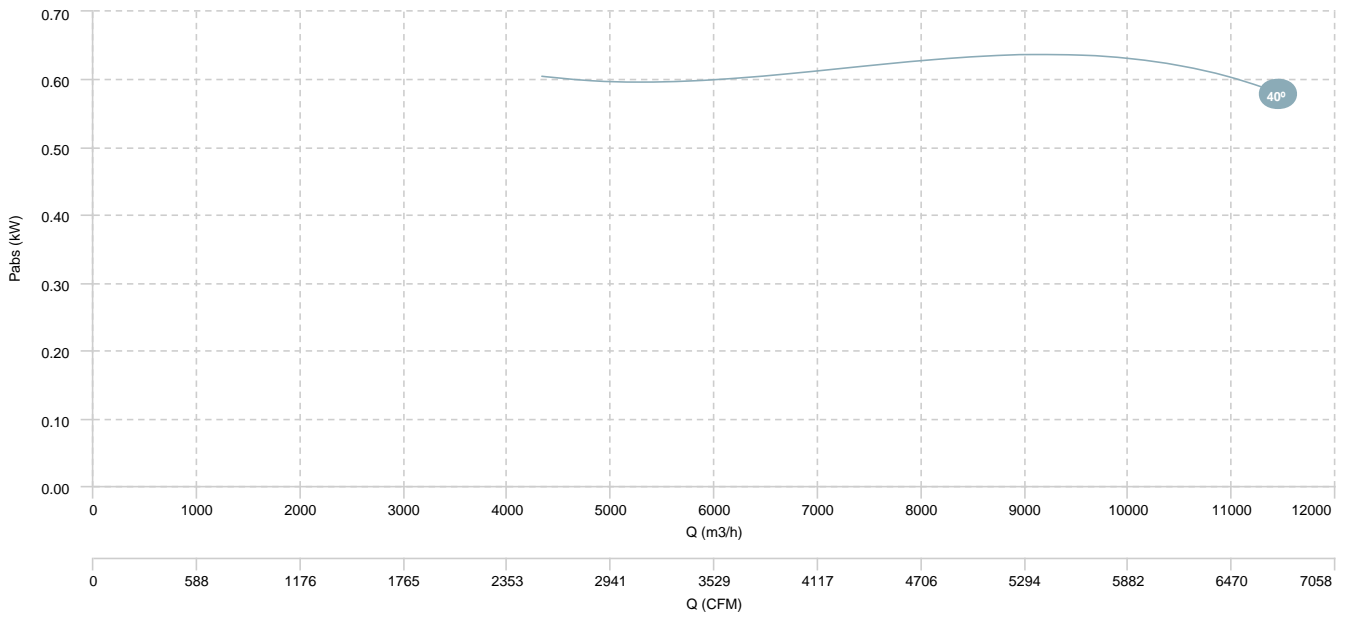

HMF 63 T4/T6 0,75/0,25kW (A5:6) F400	HMF 63 T4/T6 1,1/0,3kW (A5:6) F400	HMF 63 T4/T6 1,5/0,37kW (A5:6) F400
HMF 63 T4/T6 2,2/0,7kW (A5:6) F400		

AIR FLOW - PRESSURE (4 poles)

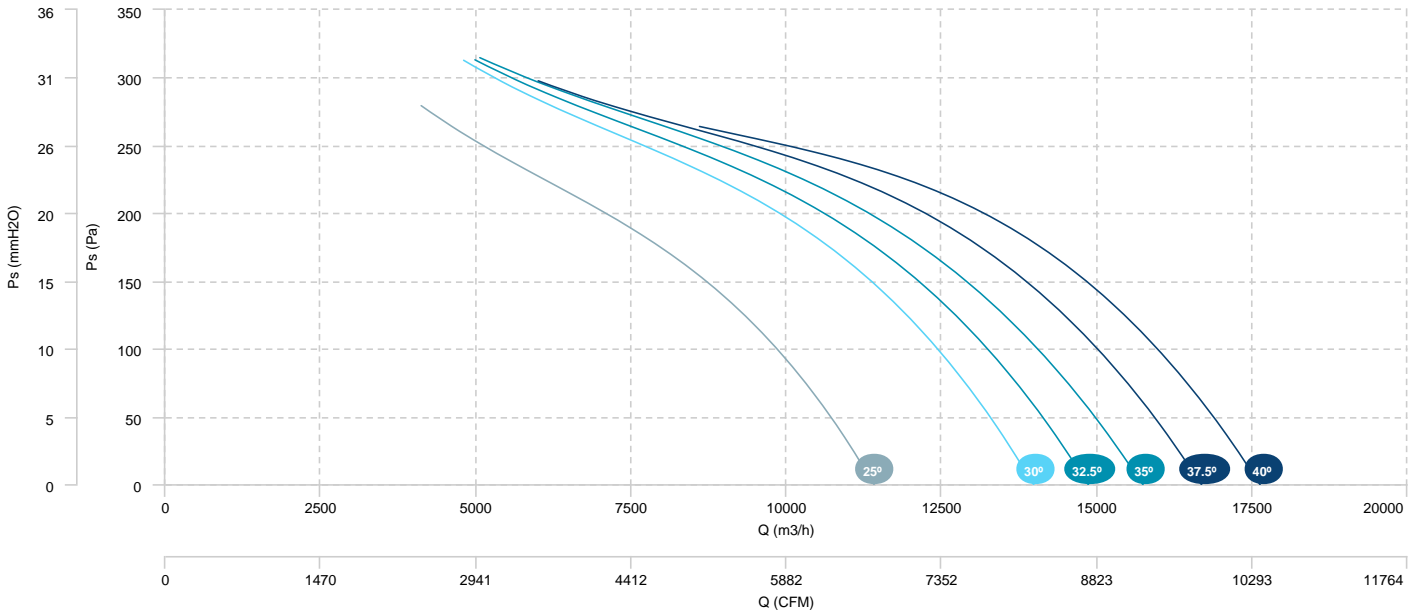

AIR FLOW - ABSORBED POWER (4 poles)

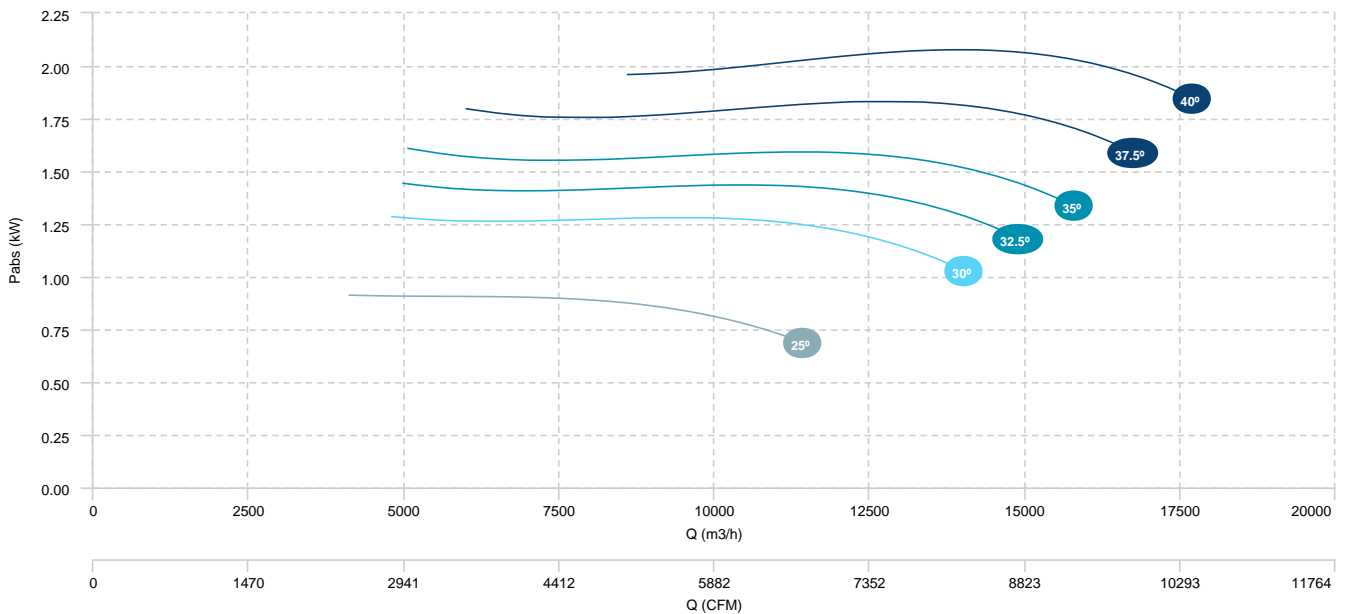

HMF 63 T4/T6 0,75/0,25kW (A5:6) F400	HMF 63 T4/T6 1,1/0,3kW (A5:6) F400	HMF 63 T4/T6 1,5/0,37kW (A5:6) F400
HMF 63 T4/T6 2,2/0,7kW (A5:6) F400		

AIR FLOW - PRESSURE (6 poles)

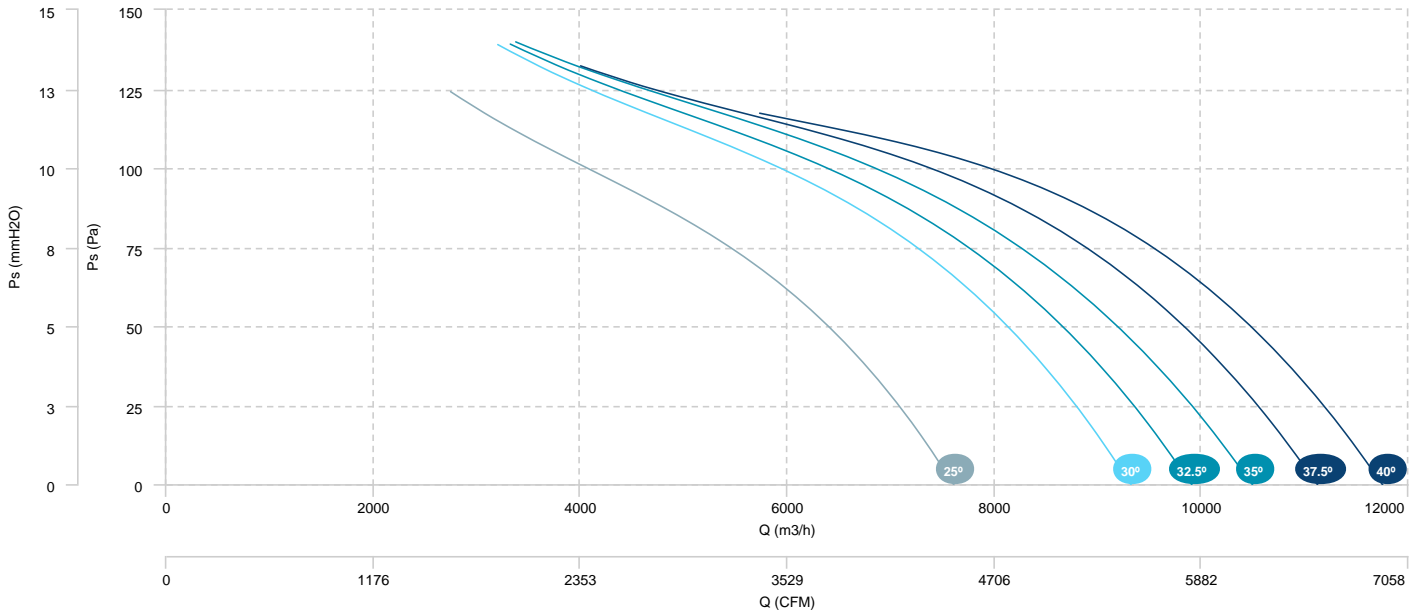

HMF 63 T4/T8 0,8/0,2kW (A5:6) F400	HMF 63 T4/T8 1,2/0,3kW (A5:6) F400	HMF 63 T4/T8 1,6/0,4kW (A5:6) F400
HMF 63 T4/T8 2,2/0,37kW (A5:6) F400		

AIR FLOW - PRESSURE (4 poles)

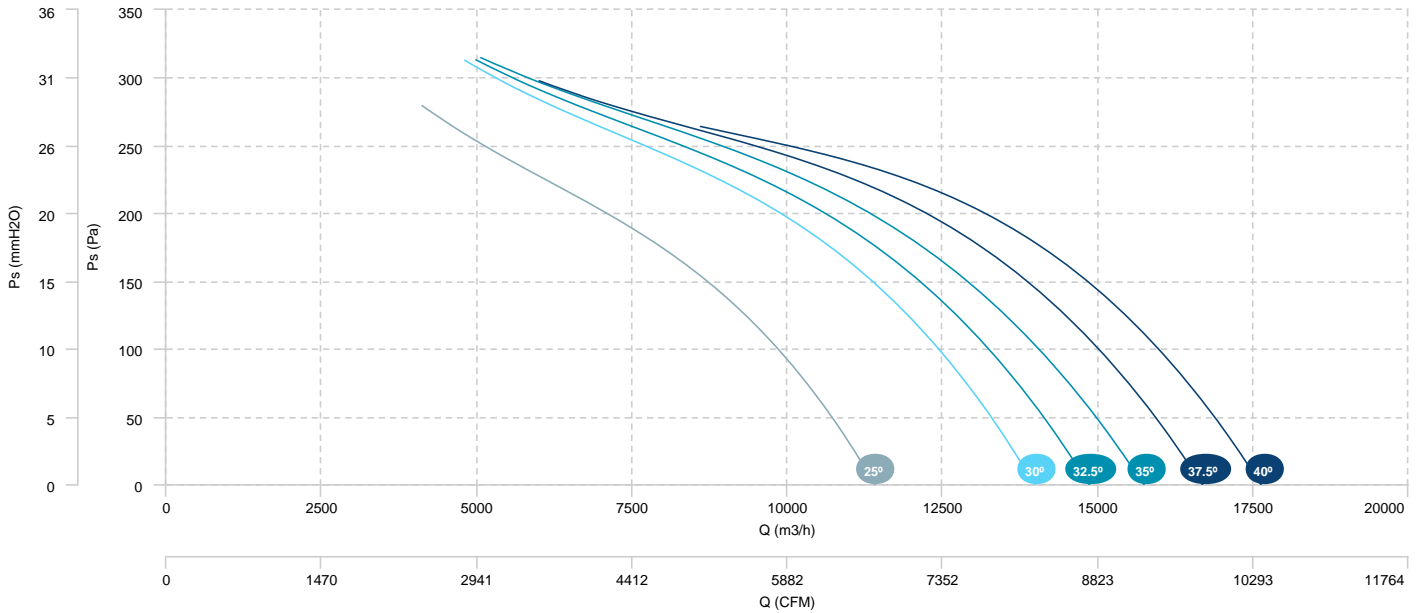

AIR FLOW - ABSORBED POWER (4 poles)

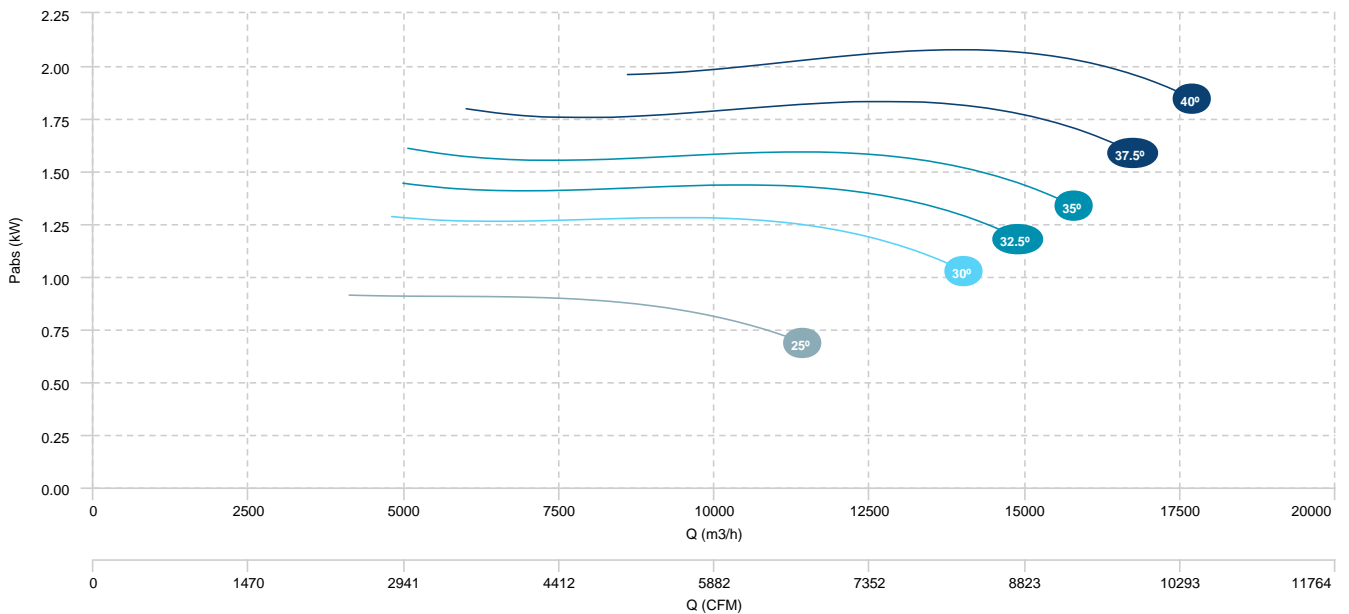

HMF 63 T4/T8 0,8/0,2kW (A5:6) F400
 HMF 63 T4/T8 2,2/0,37kW (A5:6) F400

HMF 63 T4/T8 1,2/0,3kW (A5:6) F400

HMF 63 T4/T8 1,6/0,4kW (A5:6) F400

AIR FLOW - PRESSURE (8 poles)

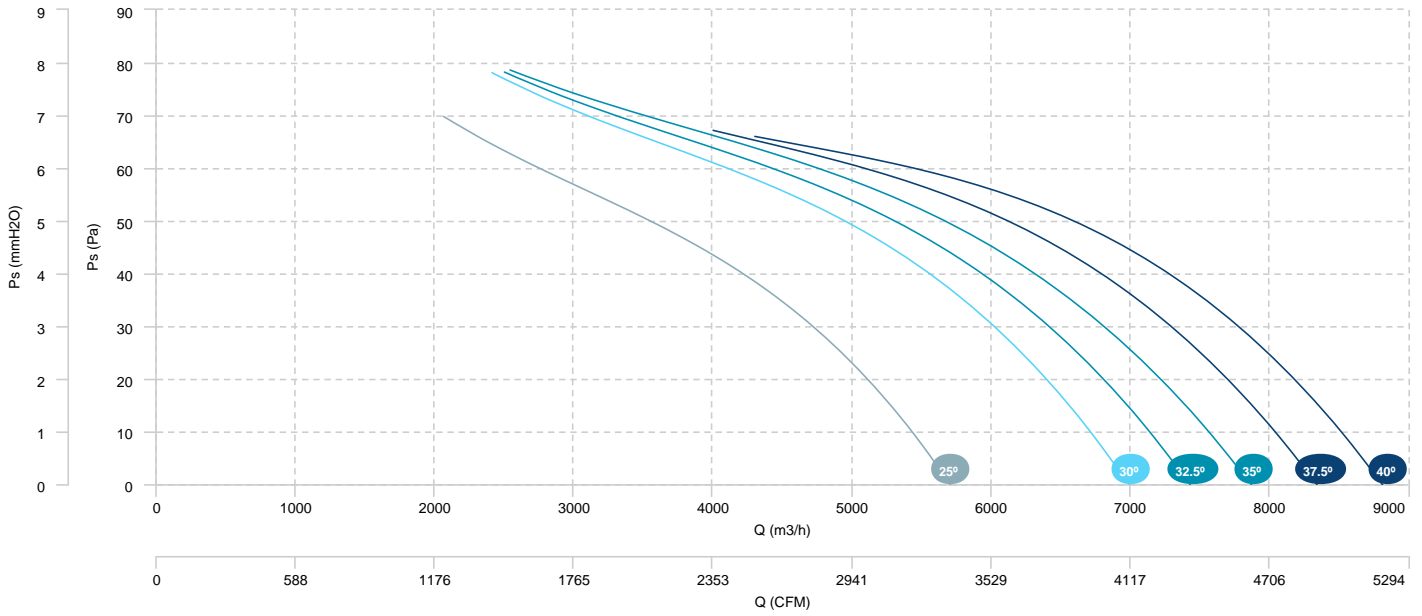

HMF 71 T4 0,75kW (A5:6) F400	HMF 71 T4 1,1kW (A5:6) F400	HMF 71 T4 1,5kW (A5:6) F400
HMF 71 T4 2,2kW (A5:6) F400	HMF 71 T4 3kW (A5:6) F400	

AIR FLOW - PRESSURE

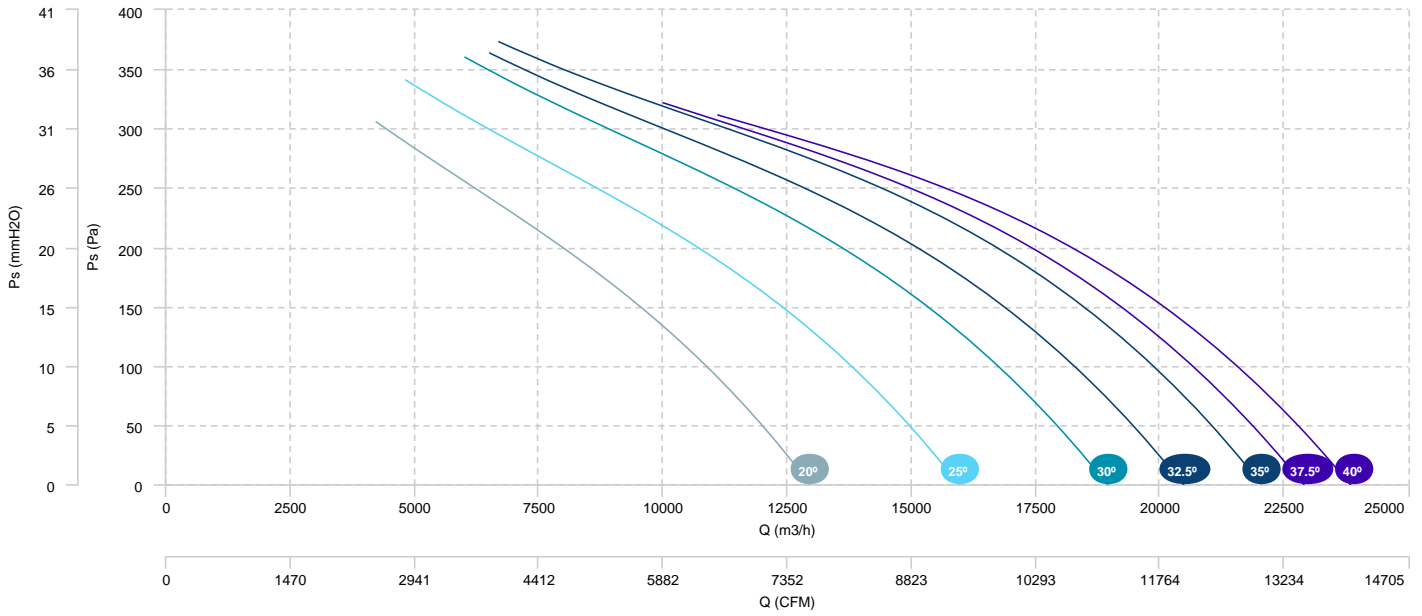

AIR FLOW - ABSORBED POWER

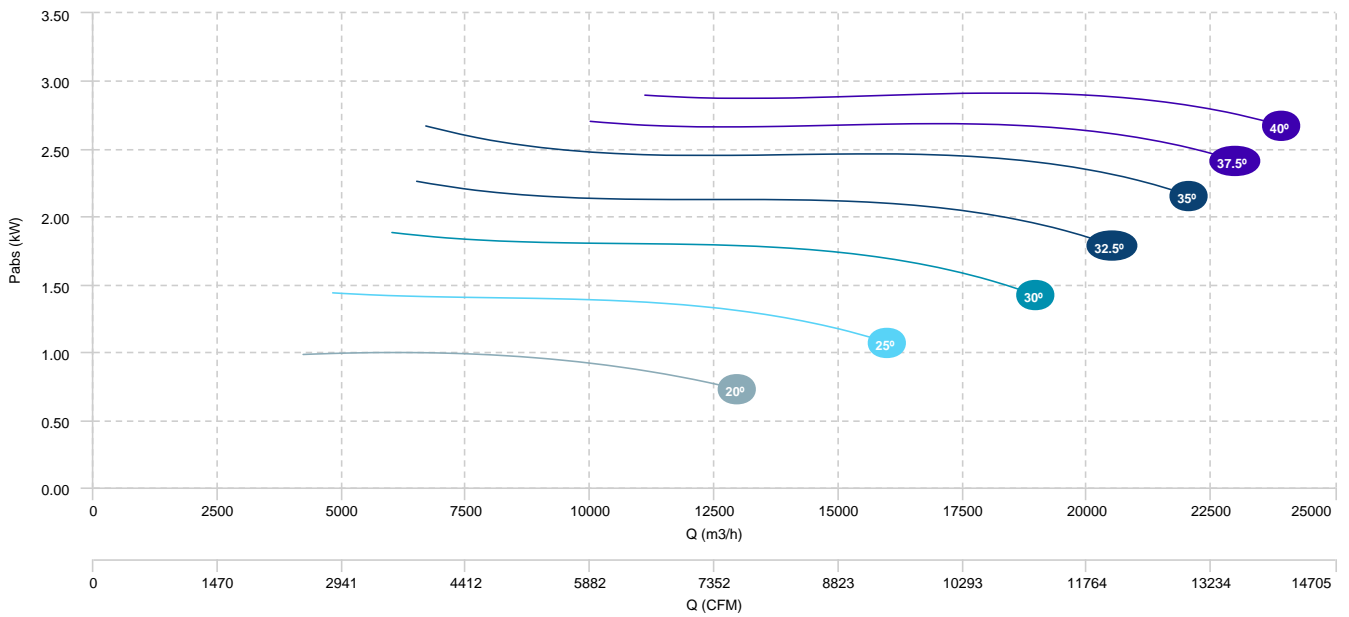

HMF 71 T6 0,75kW (A5:6) F400

AIR FLOW - PRESSURE

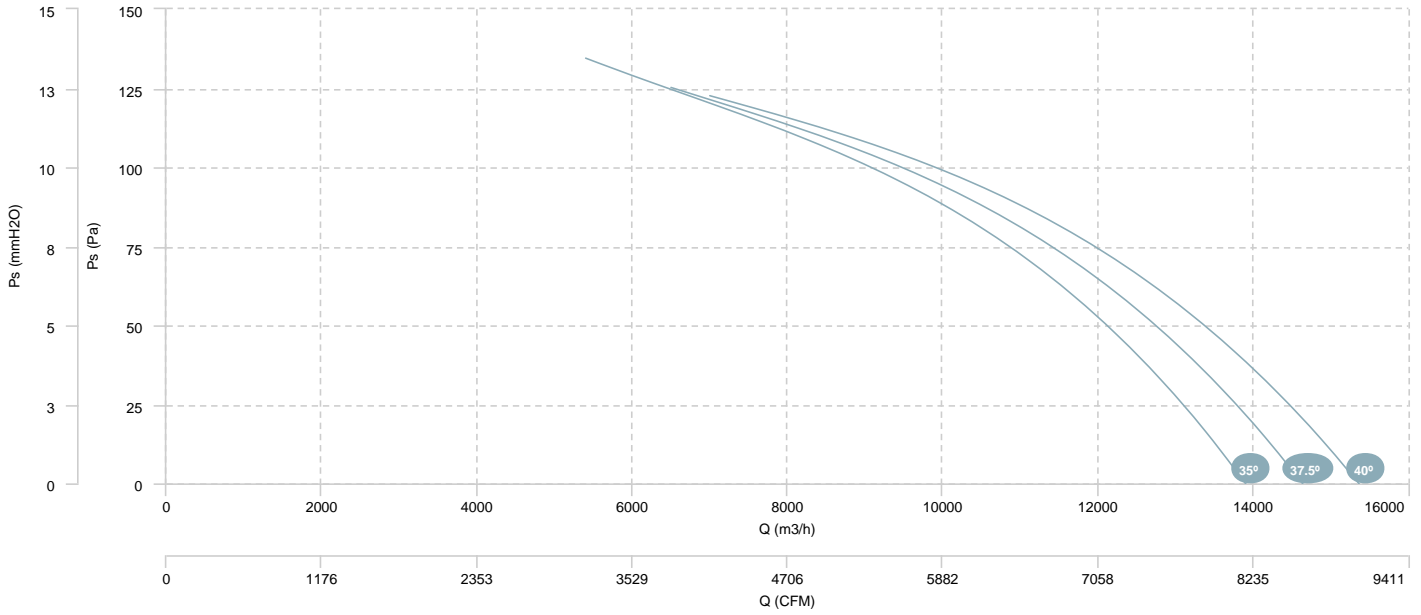

AIR FLOW - ABSORBED POWER

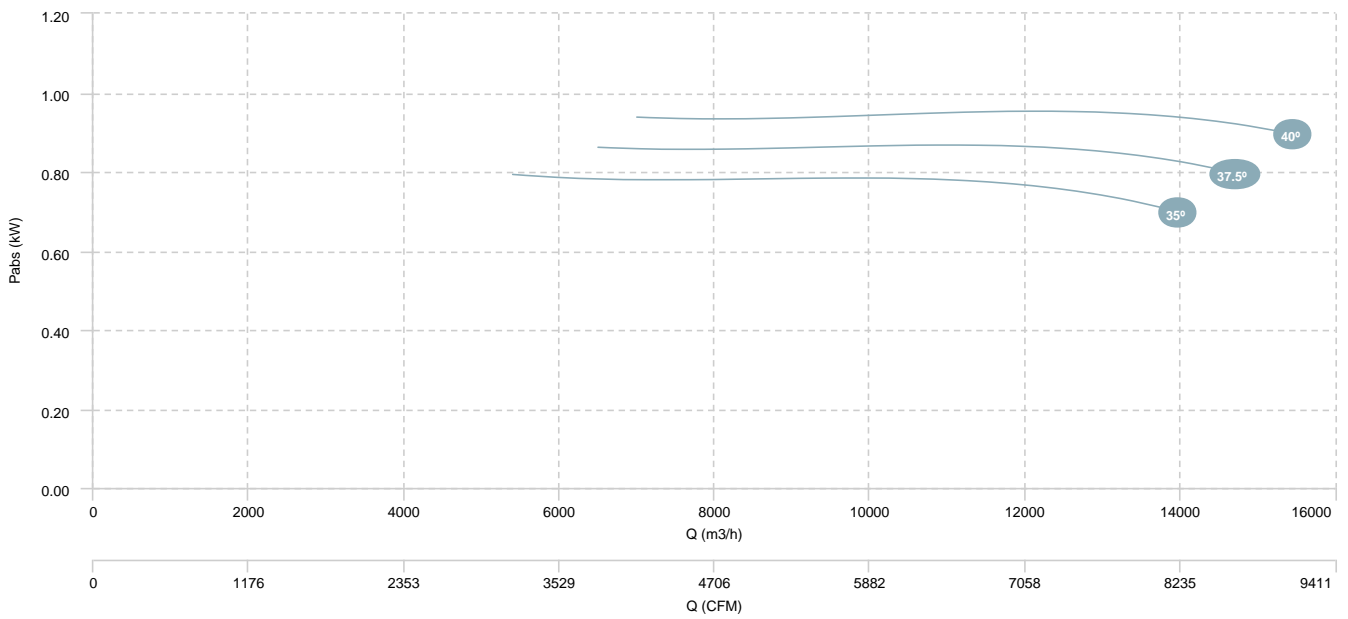

HMF 71 T4/T6 0,75/0,25kW (A5:6) F400	HMF 71 T4/T6 1,1/0,3kW (A5:6) F400	HMF 71 T4/T6 1,5/0,37kW (A5:6) F400
HMF 71 T4/T6 2,2/0,7kW (A5:6) F400	HMF 71 T4/T6 3/1kW (A5:6) F400	

AIR FLOW - PRESSURE (4 poles)

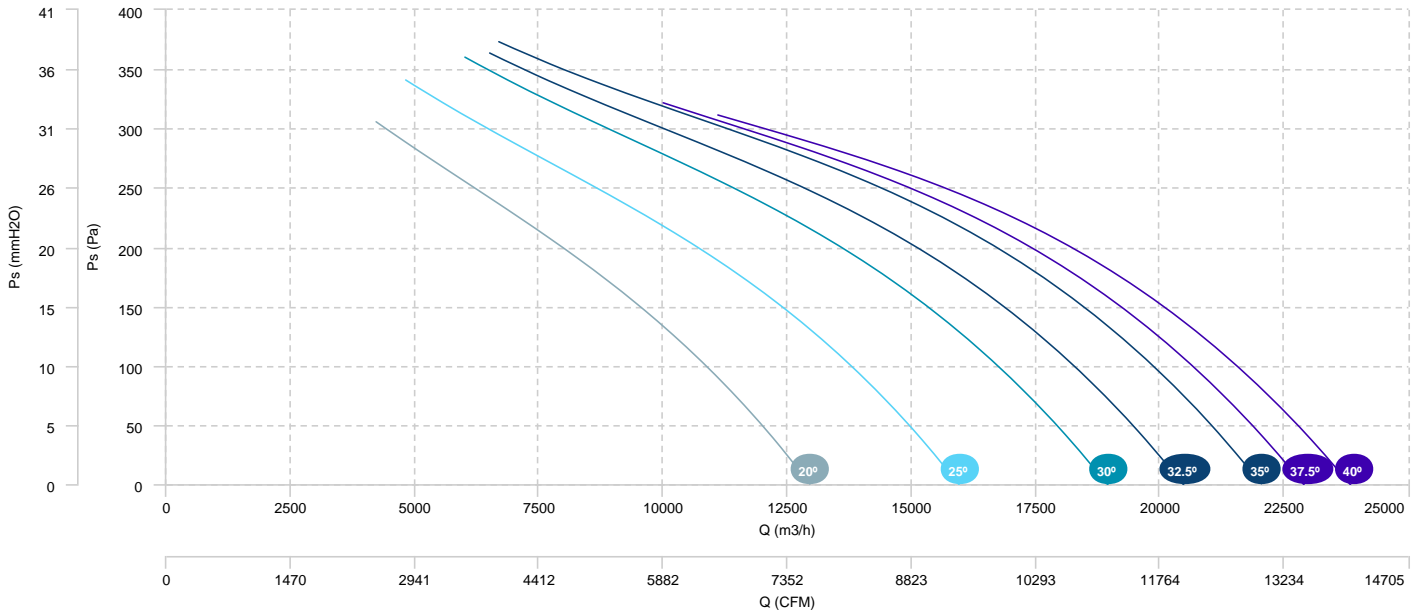

AIR FLOW - ABSORBED POWER (4 poles)

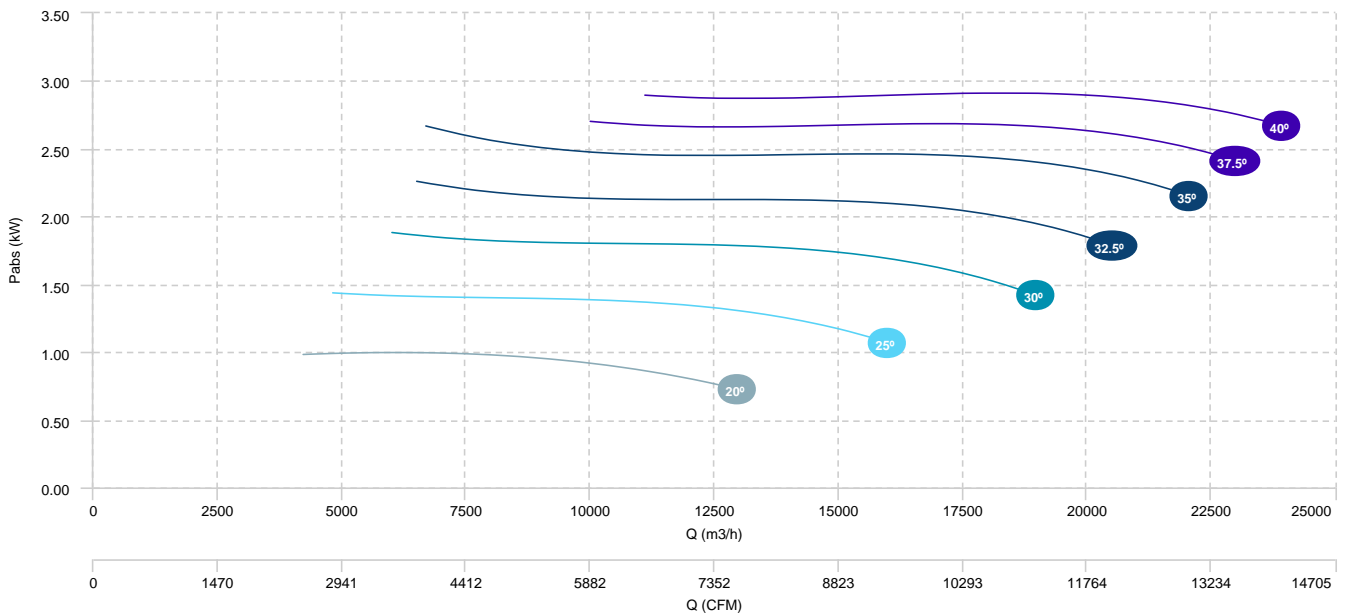

HMF 71 T4/T6 0,75/0,25kW (A5:6) F400	HMF 71 T4/T6 1,1/0,3kW (A5:6) F400	HMF 71 T4/T6 1,5/0,37kW (A5:6) F400
HMF 71 T4/T6 2,2/0,7kW (A5:6) F400	HMF 71 T4/T6 3/1kW (A5:6) F400	

AIR FLOW - PRESSURE (6 poles)

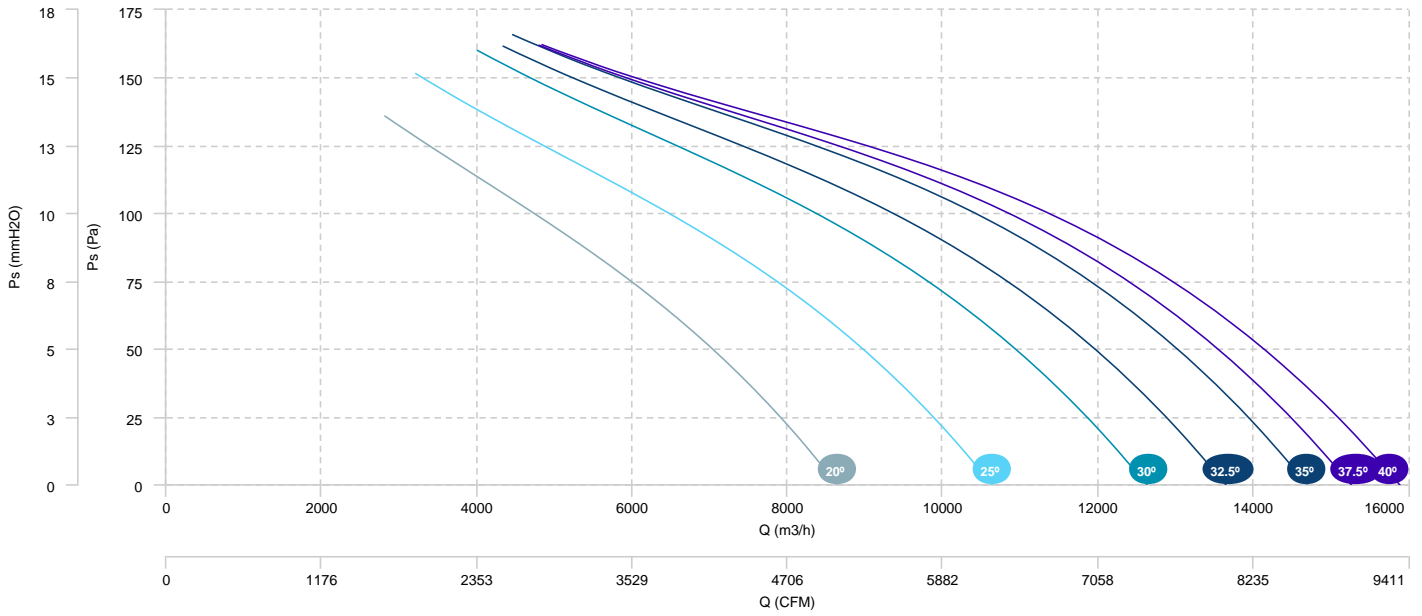

HMF 71 T4/T8 0,8/0,2kW (A5:6) F400	HMF 71 T4/T8 1,2/0,3kW (A5:6) F400	HMF 71 T4/T8 1,6/0,4kW (A5:6) F400
HMF 71 T4/T8 2,2/0,37kW (A5:6) F400	HMF 71 T4/T8 3/0,55kW (A5:6) F400	

AIR FLOW - PRESSURE (4 poles)

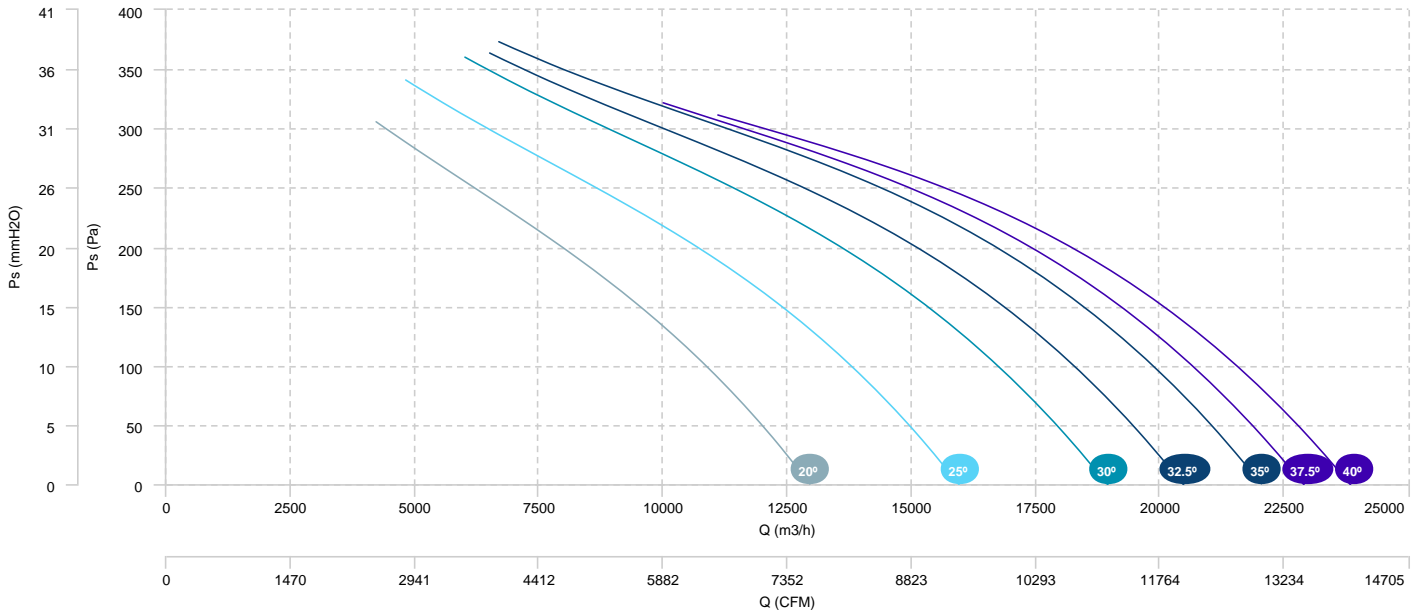

AIR FLOW - ABSORBED POWER (4 poles)

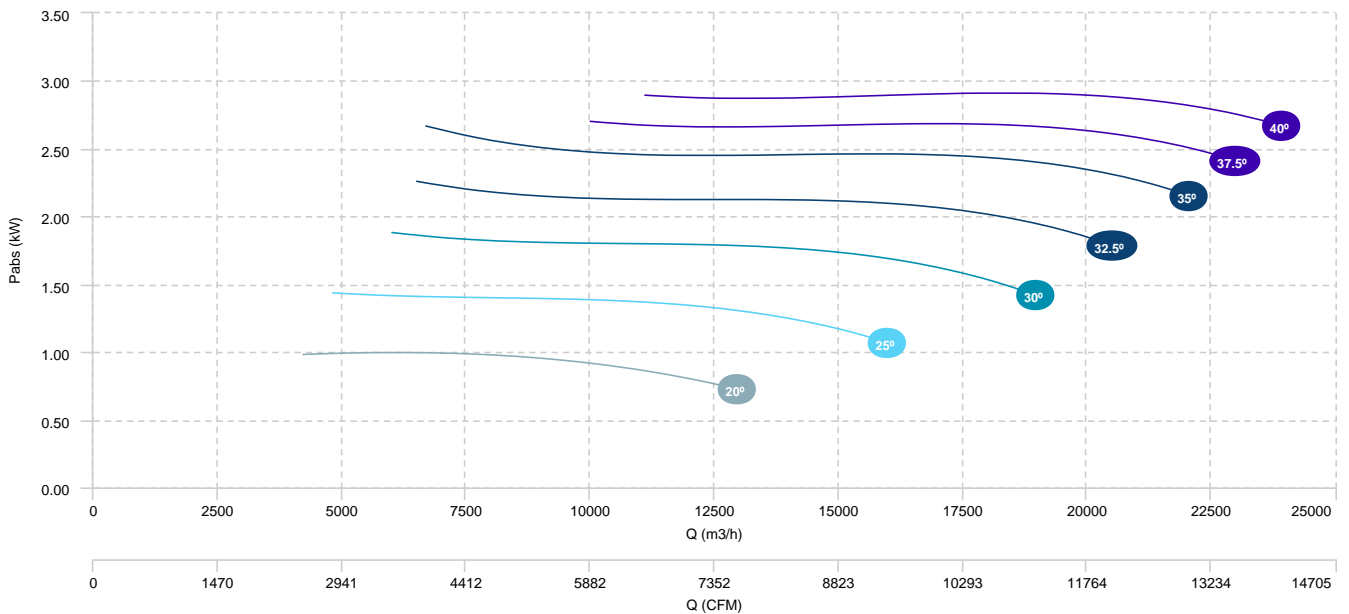

HMF 71 T4/T8 0,8/0,2kW (A5:6) F400	HMF 71 T4/T8 1,2/0,3kW (A5:6) F400	HMF 71 T4/T8 1,6/0,4kW (A5:6) F400
HMF 71 T4/T8 2,2/0,37kW (A5:6) F400	HMF 71 T4/T8 3/0,55kW (A5:6) F400	

AIR FLOW - PRESSURE (8 poles)

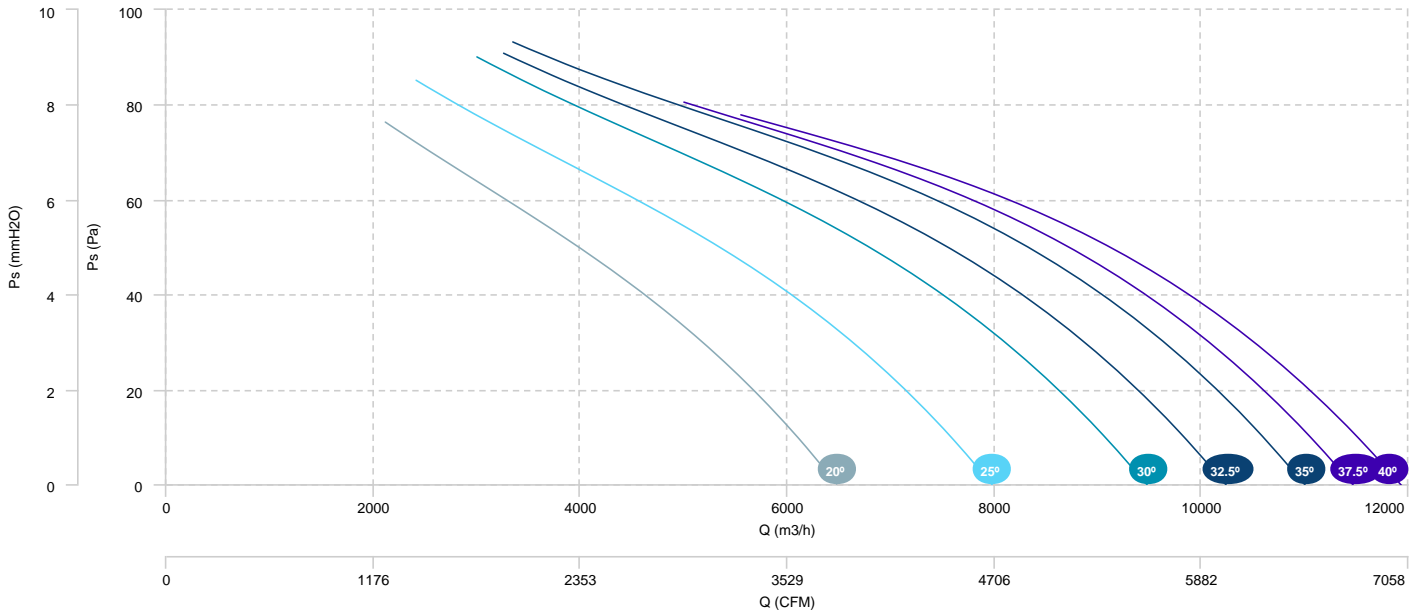

HMF 80 T4 3kW (A5:6) F400

HMF 80 T4 4kW (A5:6) F400

AIR FLOW - PRESSURE

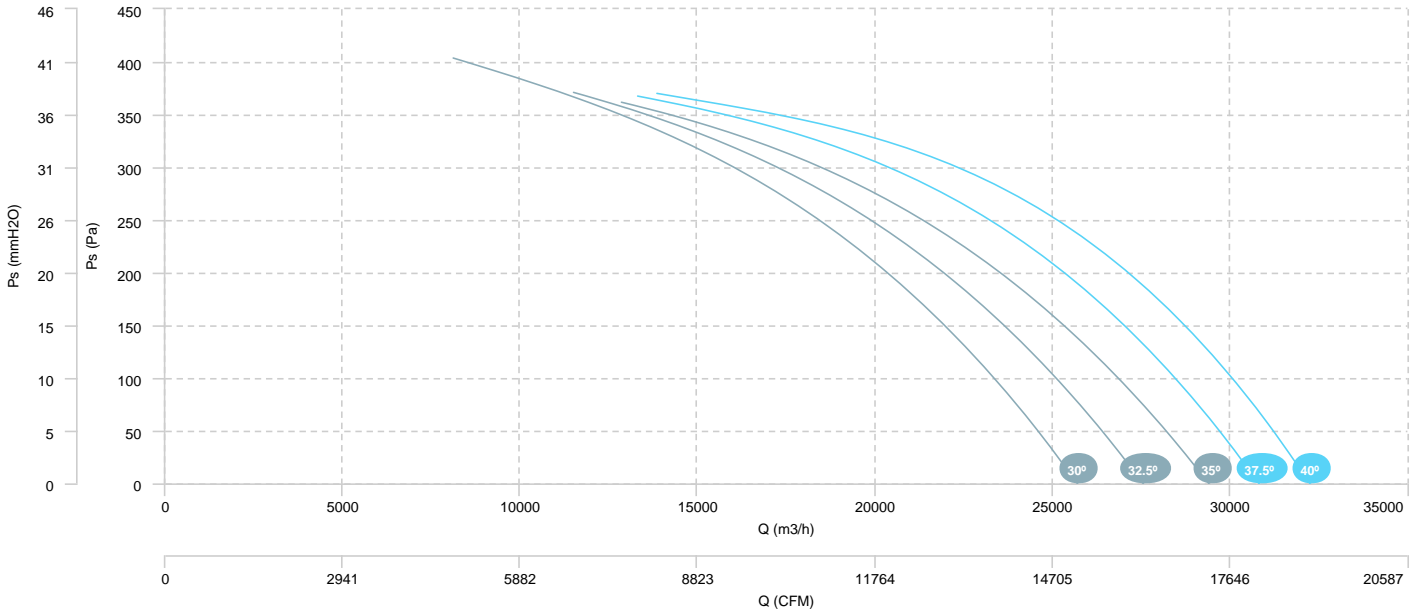

AIR FLOW - ABSORBED POWER

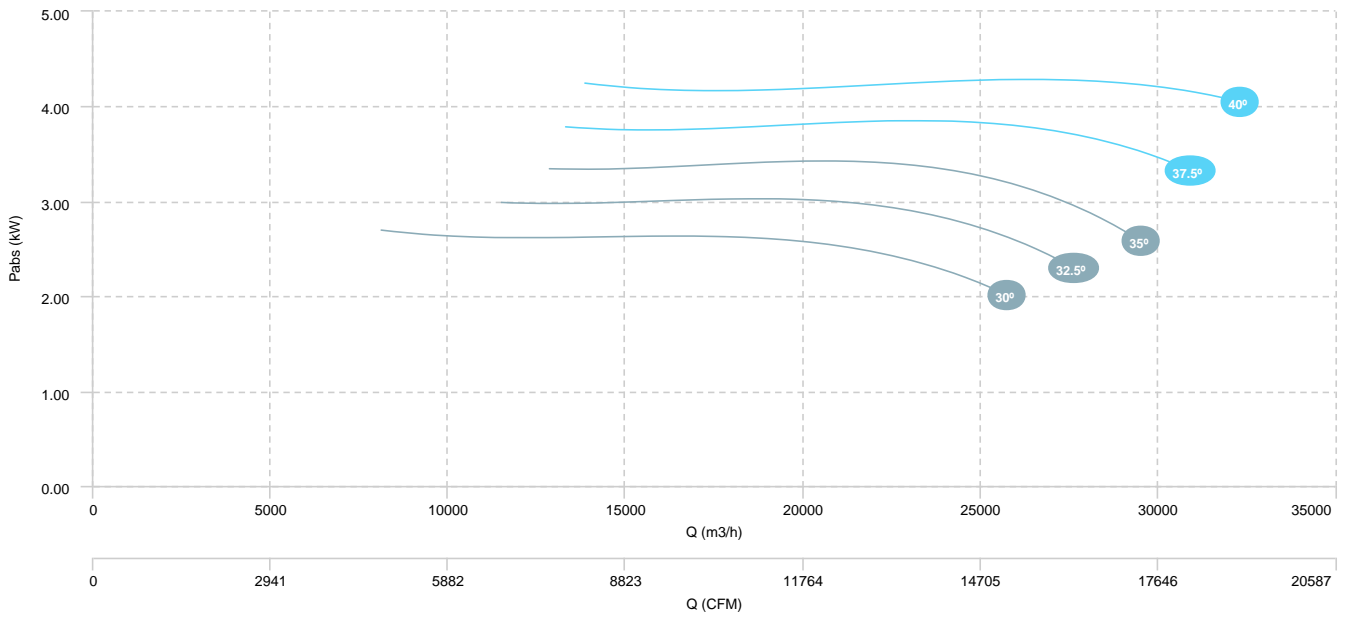

HMF 80 T6 0,75kW (A5:6) F400	HMF 80 T6 1,1kW (A5:6) F400	HMF 80 T6 1,5kW (A5:6) F400
HMF 80 T6 2,2kW (A5:6) F400		

AIR FLOW - PRESSURE

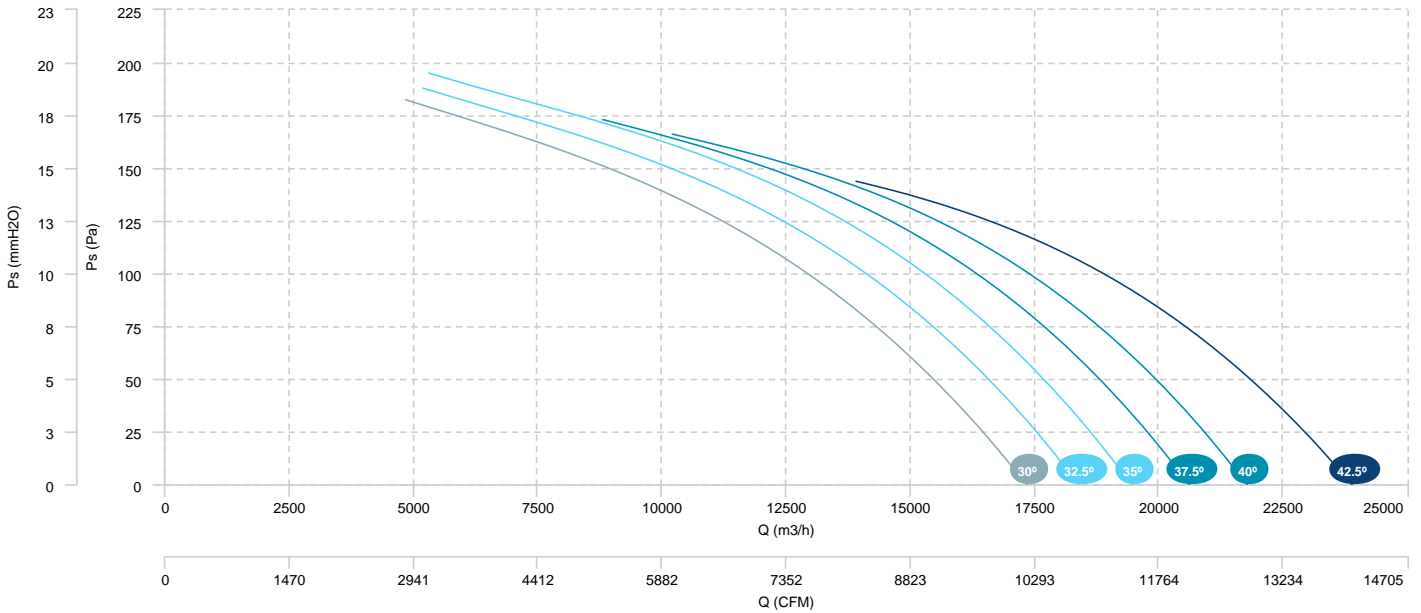

AIR FLOW - ABSORBED POWER

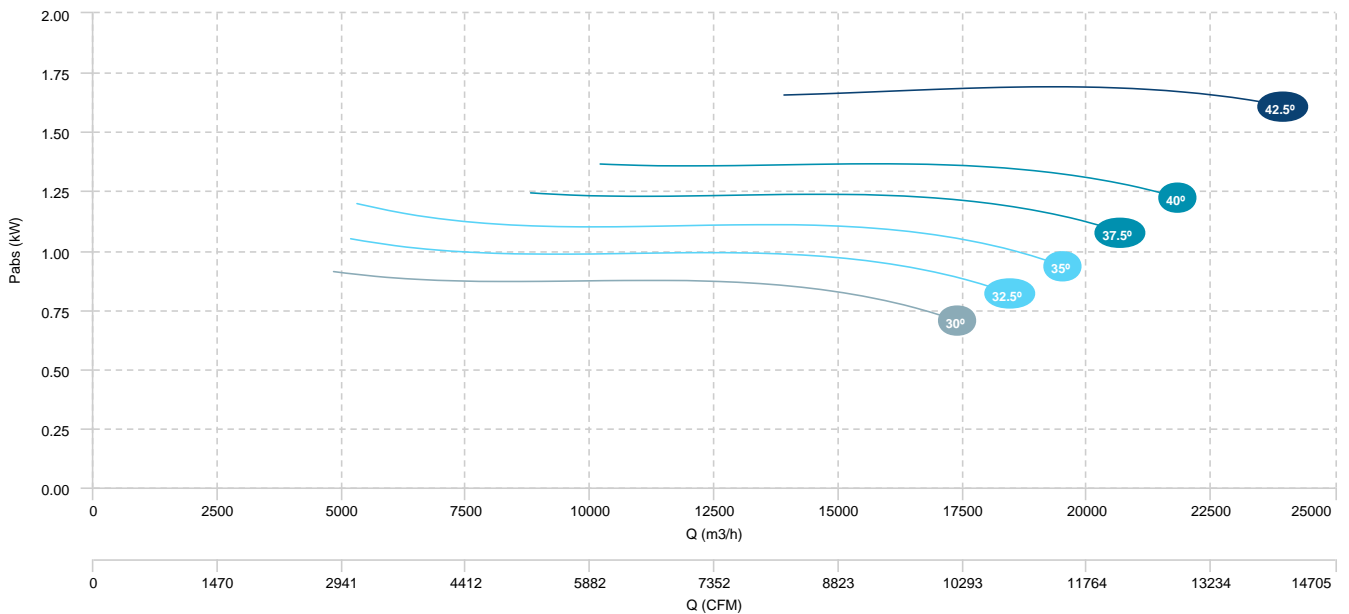

HMF 80 T4/T6 3/1kW (A5:6) F400

HMF 80 T4/T6 4,5/1,5kW (A5:6) F400

AIR FLOW - PRESSURE (4 poles)

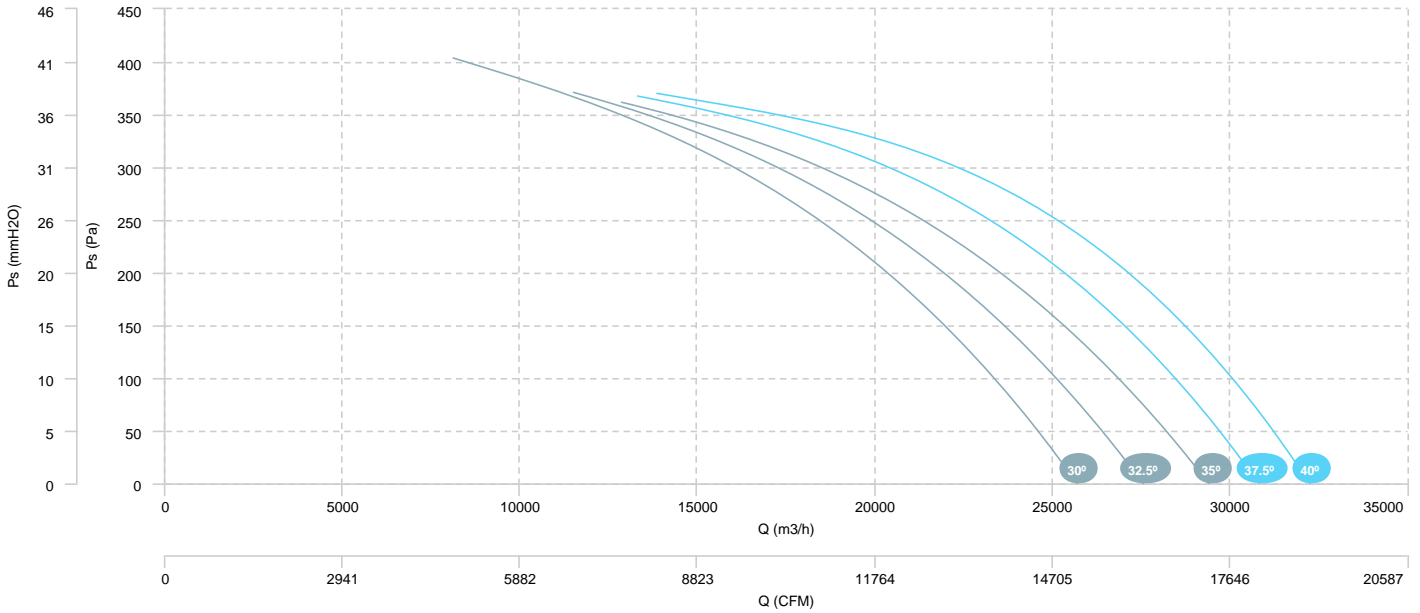

AIR FLOW - ABSORBED POWER (4 poles)

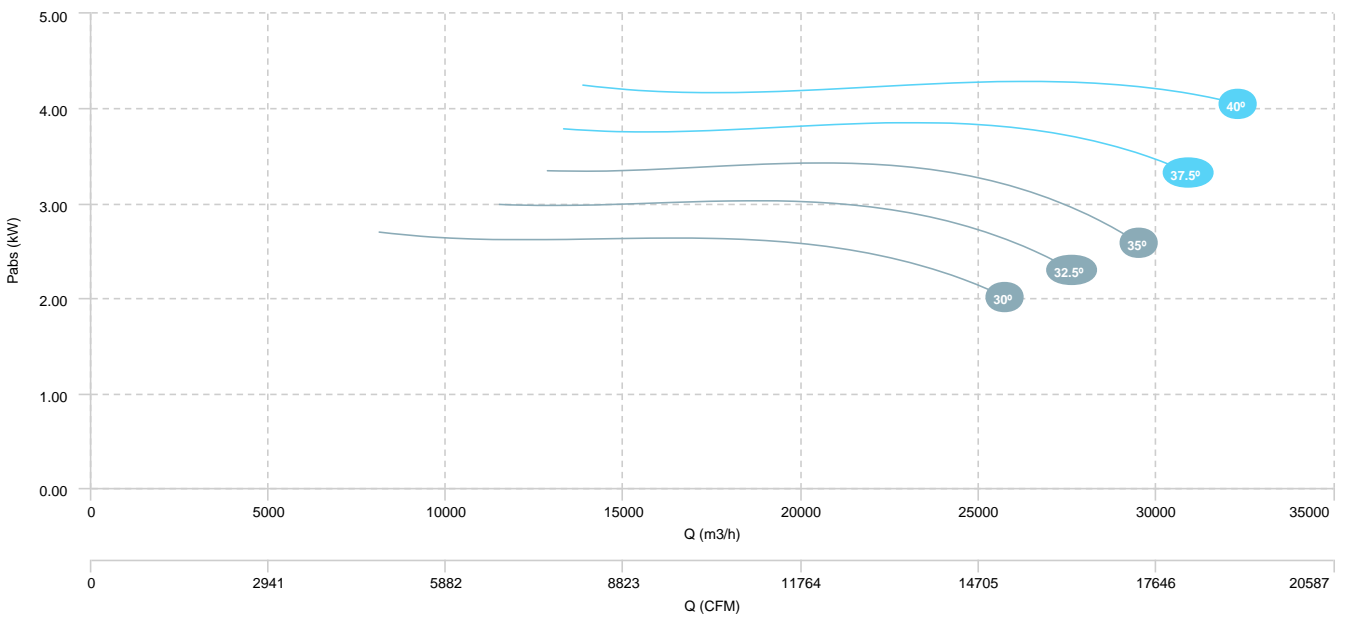

HMF 80 T4/T6 3/1kW (A5:6) F400

HMF 80 T4/T6 4,5/1,5kW (A5:6) F400

AIR FLOW - PRESSURE (6 poles)

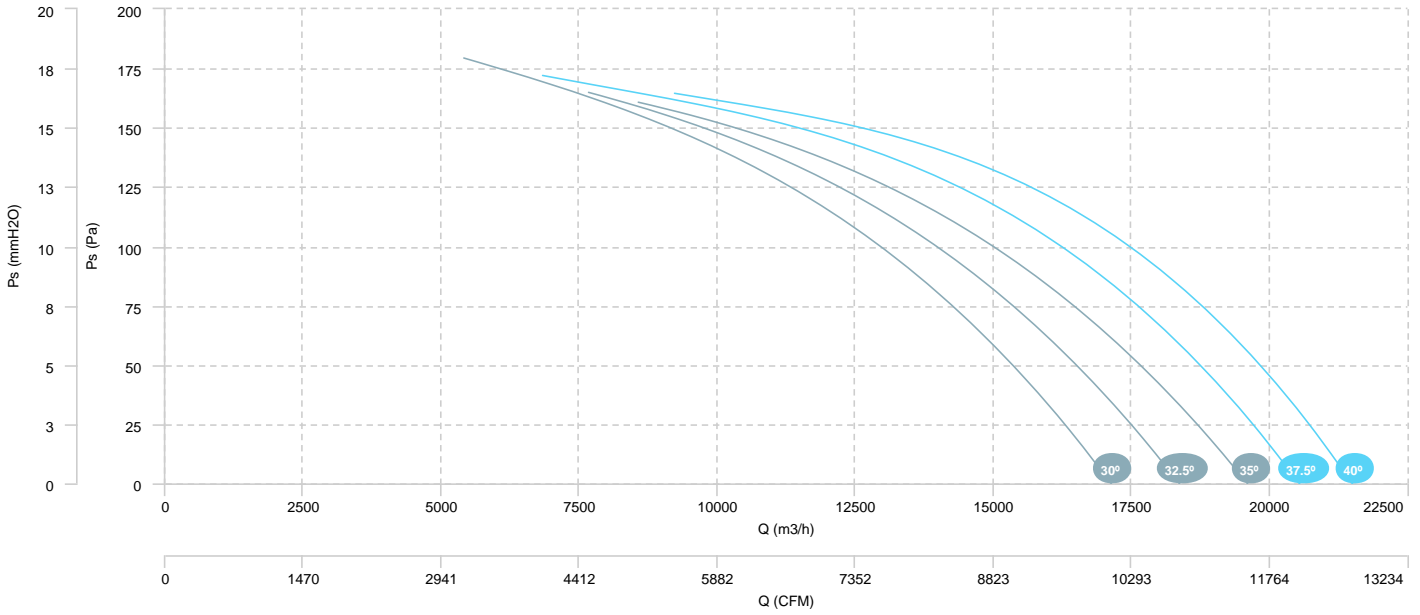

HMF 80 T4/T8 3/0,55kW (A5:6) F400

HMF 80 T4/T8 4/0,75kW (A5:6) F400

AIR FLOW - PRESSURE (4 poles)

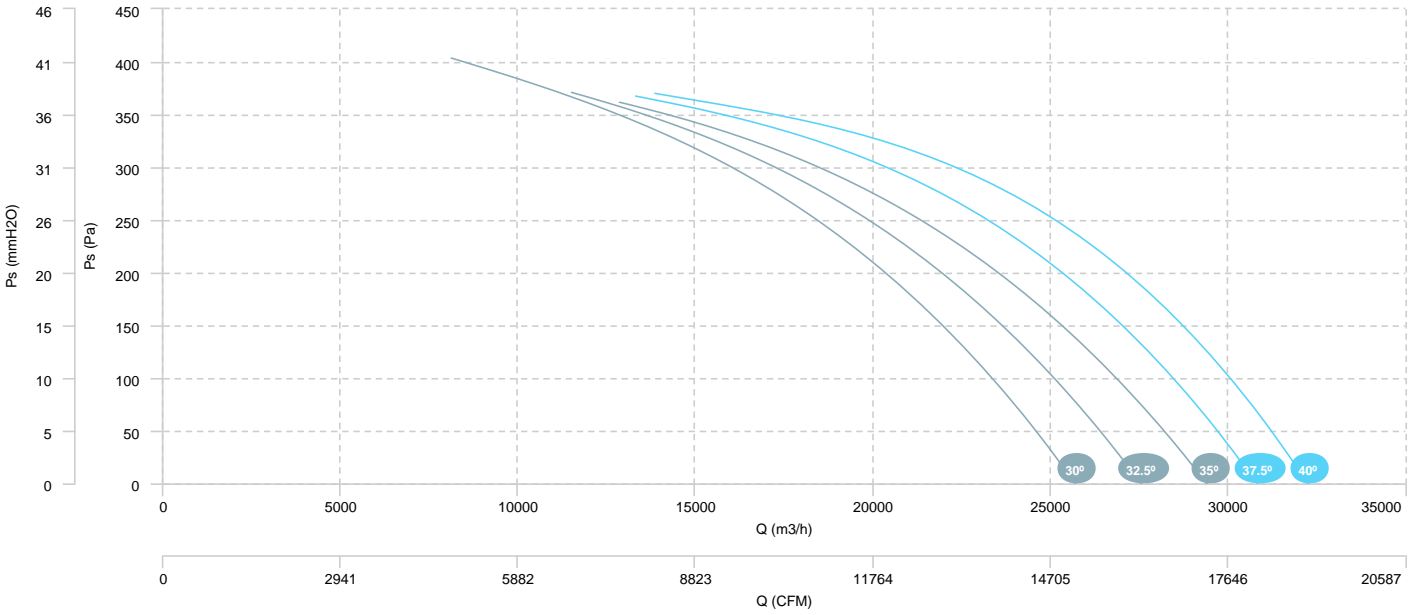

AIR FLOW - ABSORBED POWER (4 poles)

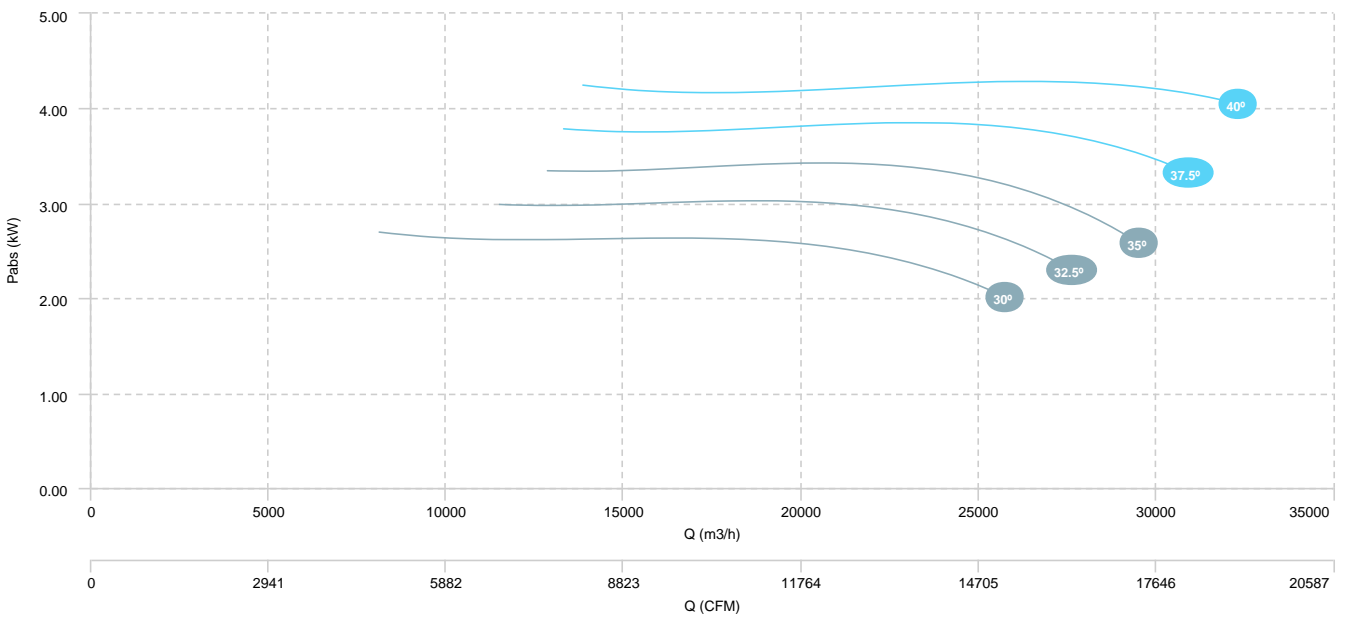

HMF 80 T4/T8 3/0,55kW (A5:6) F400

HMF 80 T4/T8 4/0,75kW (A5:6) F400

AIR FLOW - PRESSURE (8 poles)

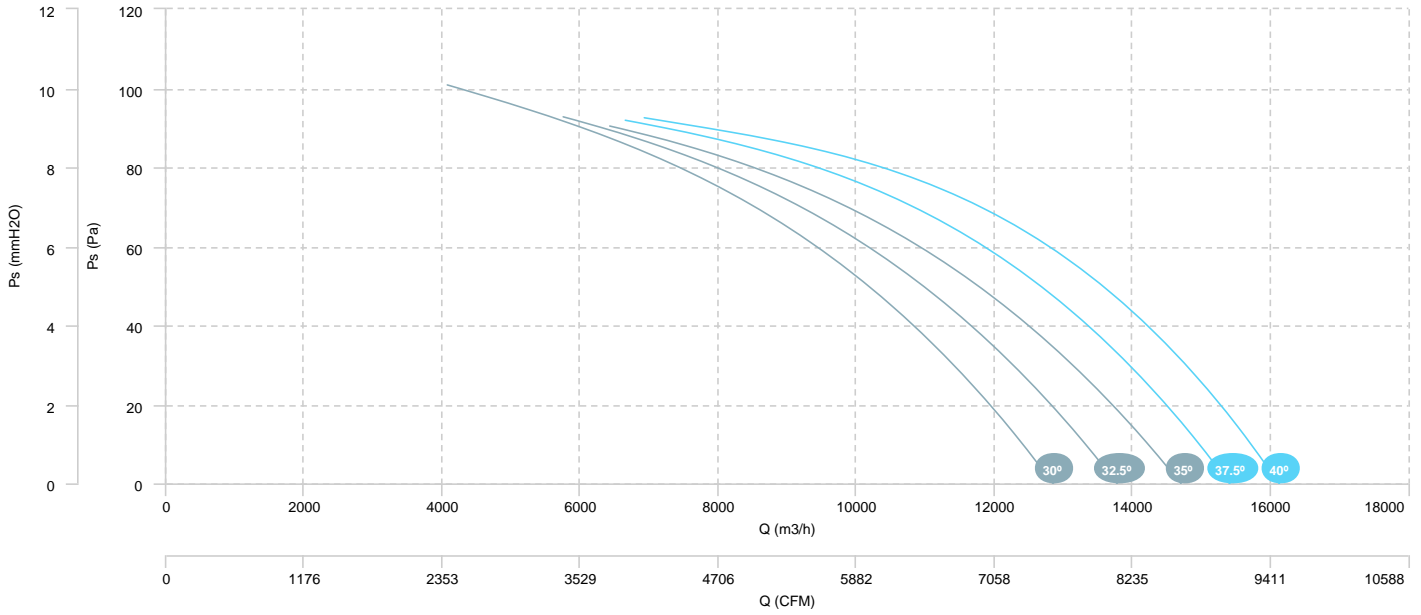

HMF 90 T4 5,5kW (A3:8) F400	HMF 90 T4 7,5kW (A3:8) F400	HMF 90 T4 11kW (A3:8) F400
HMF 90 T4 15kW (A3:8) F400		

AIR FLOW - PRESSURE

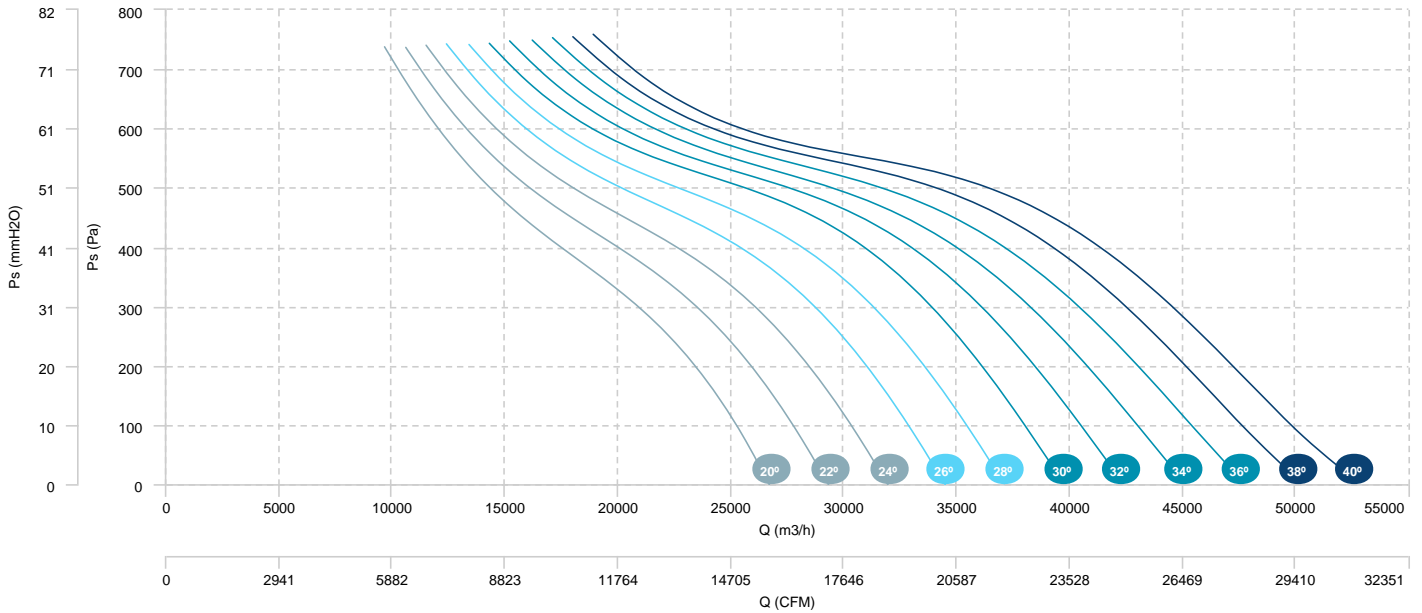

AIR FLOW - ABSORBED POWER

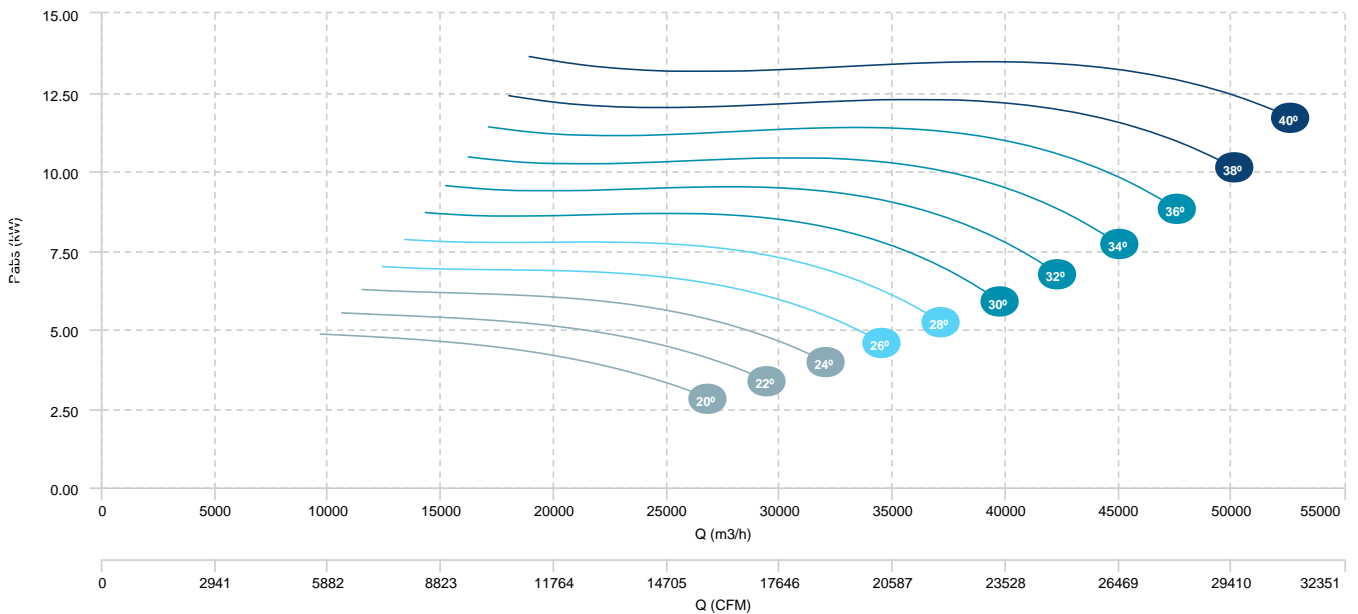

HMF 90 T4 3kW (A3:4) F400	HMF 90 T4 4kW (A3:4) F400	HMF 90 T4 5,5kW (A3:4) F400
HMF 90 T4 7,5kW (A3:4) F400	HMF 90 T4 11kW (A3:4) F400	

AIR FLOW - PRESSURE

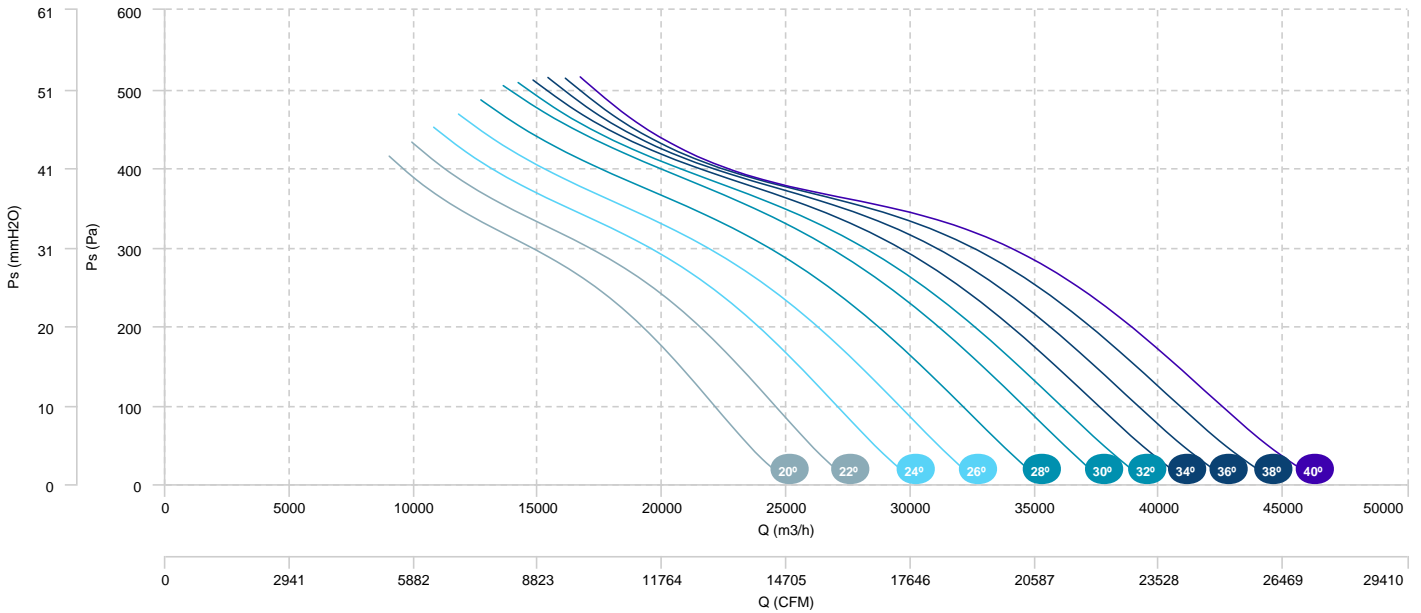

AIR FLOW - ABSORBED POWER

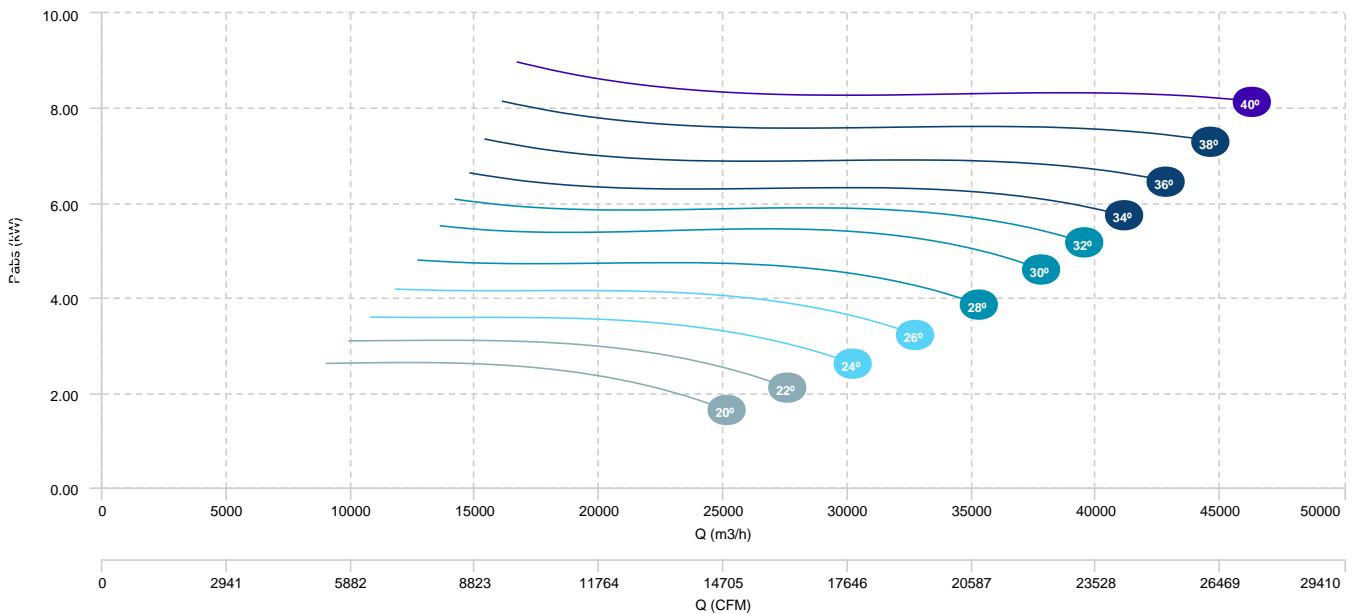

HMF 90 T6 1,5kW (A3:8) F400	HMF 90 T6 2,2kW (A3:8) F400	HMF 90 T6 3kW (A3:8) F400
HMF 90 T6 4kW (A3:8) F400		

AIR FLOW - PRESSURE

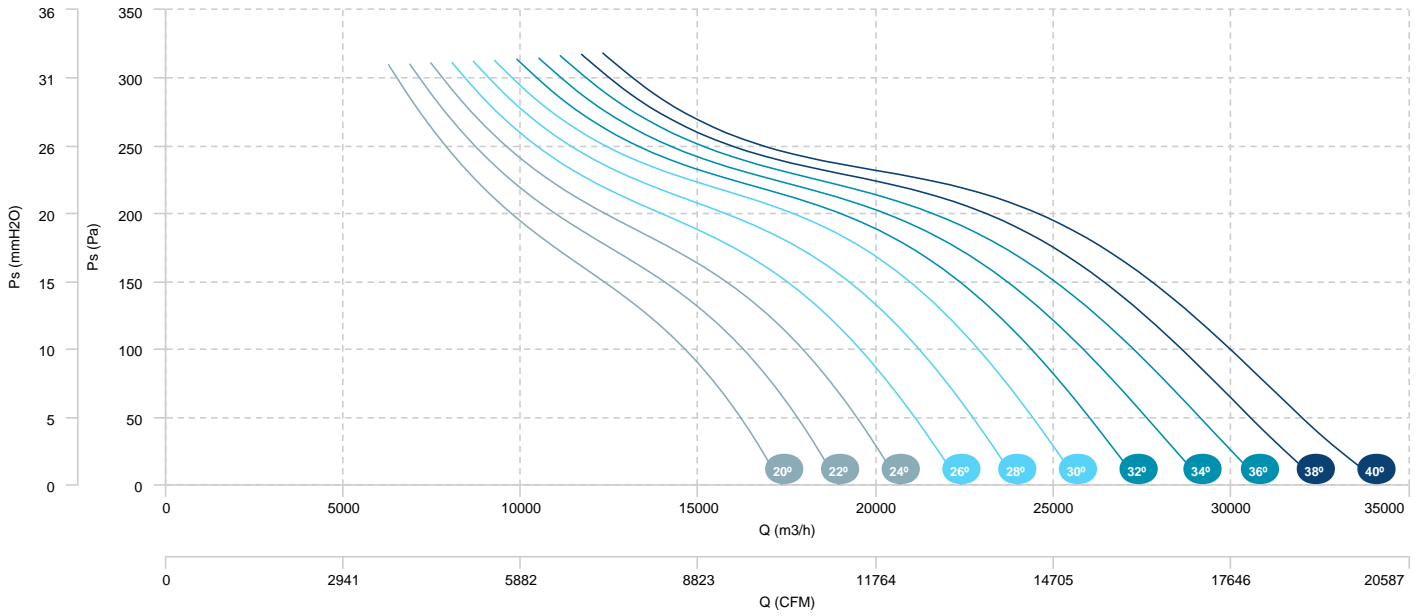

AIR FLOW - ABSORBED POWER

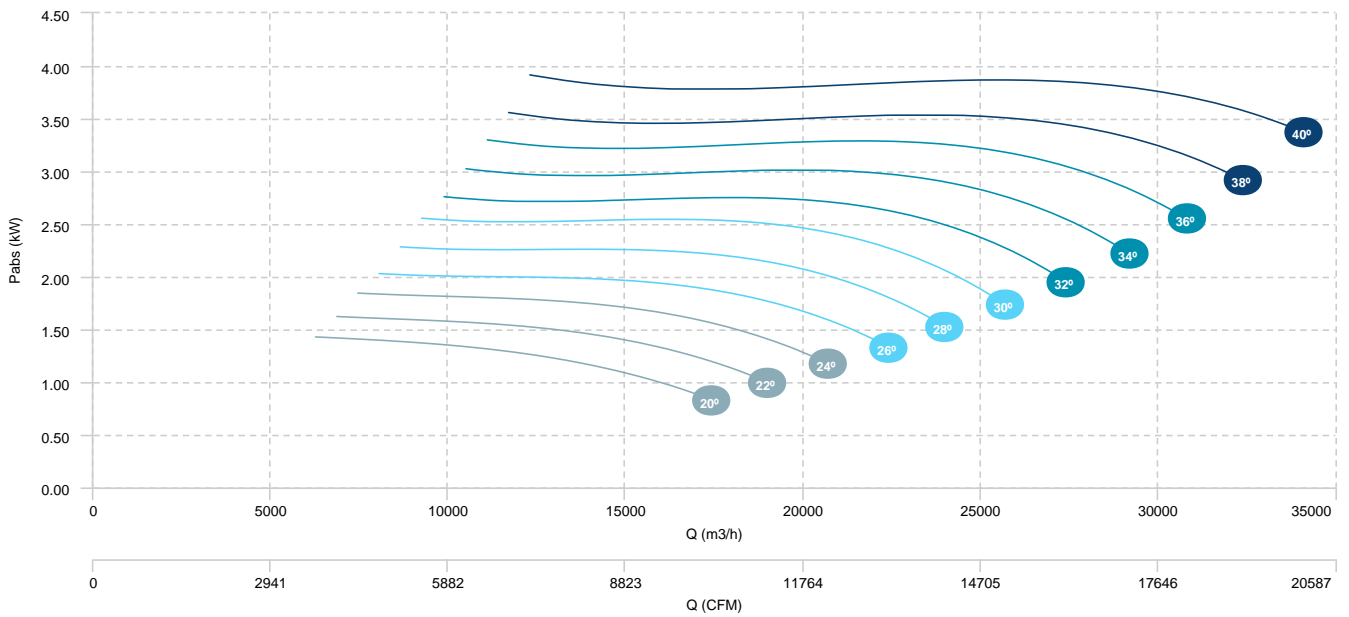

HMF 90 T6 1,5kW (A3:4) F400

HMF 90 T6 2,2kW (A3:4) F400

AIR FLOW - PRESSURE

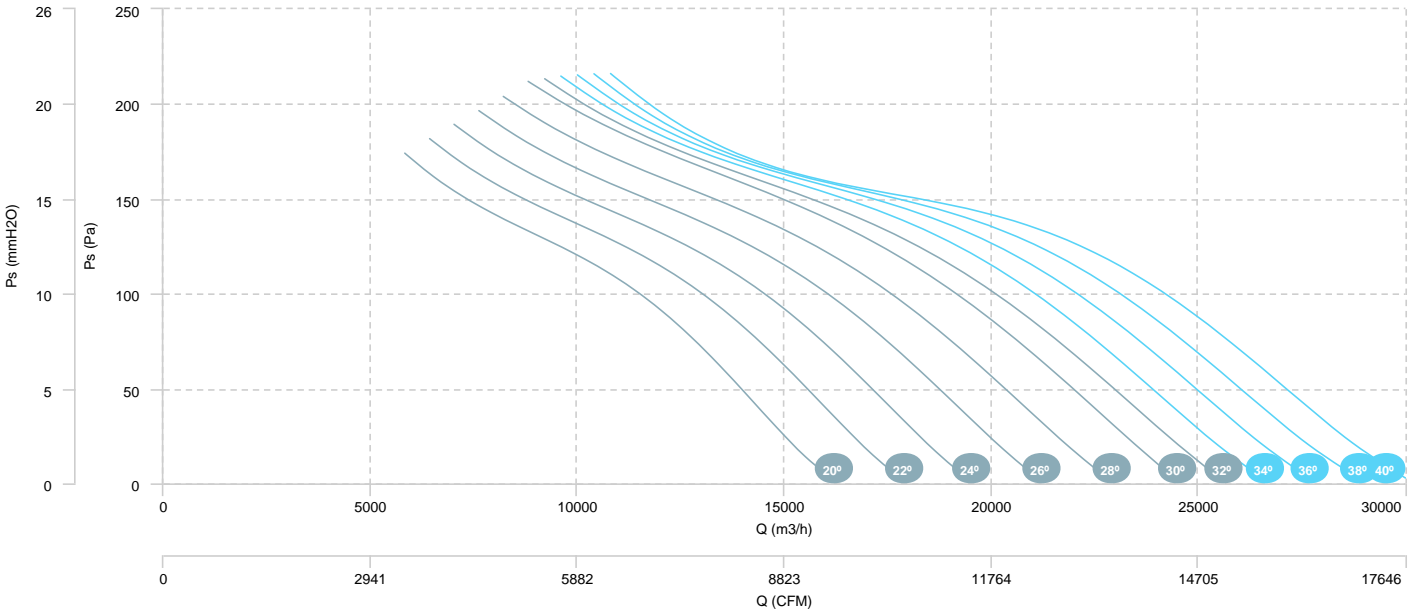

AIR FLOW - ABSORBED POWER

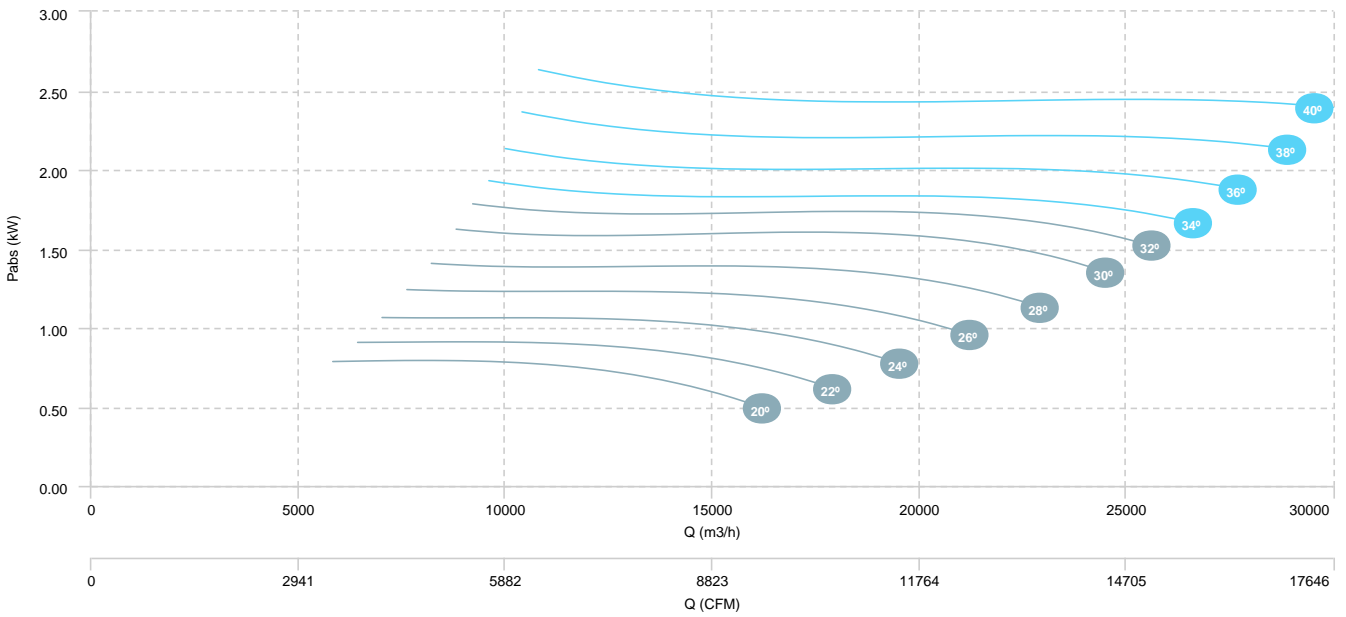

HMF 90 T4/T6 4,5/1,5kW (A3:8) F400	HMF 90 T4/T6 6/2,2kW (A3:8) F400	HMF 90 T4/T6 10/3,3kW (A3:8) F400
HMF 90 T4/T6 14/4,5kW (A3:8) F400		

AIR FLOW - PRESSURE (4 poles)

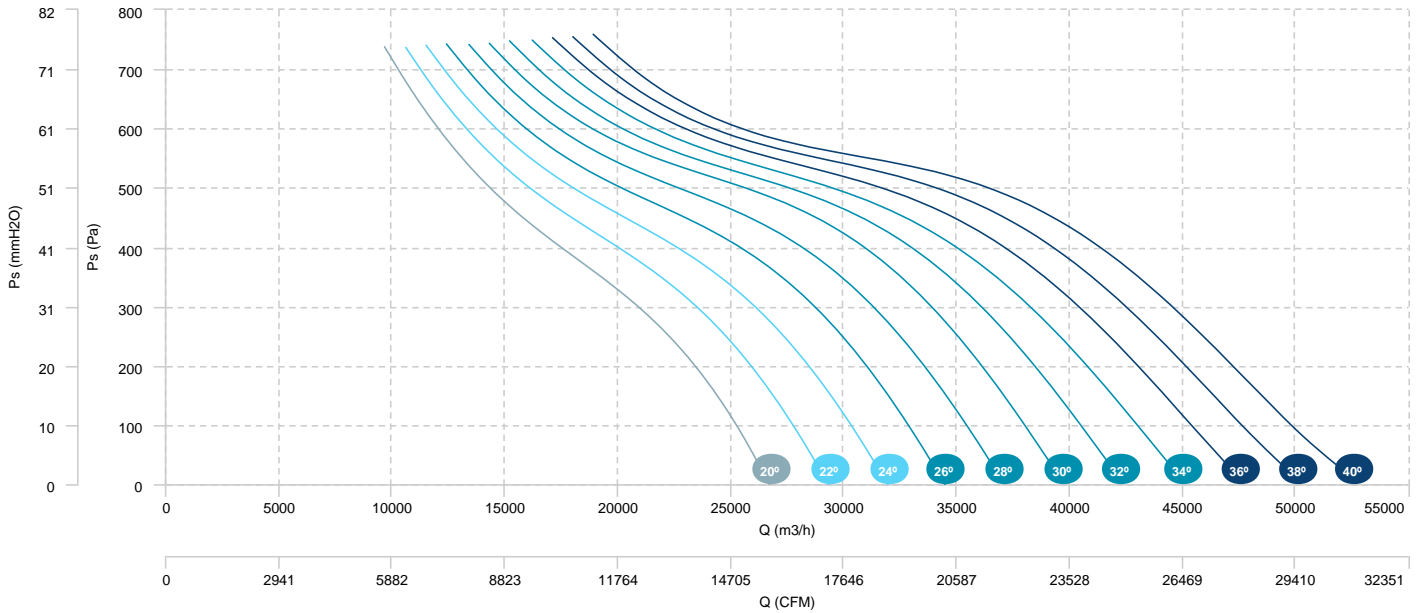

AIR FLOW - ABSORBED POWER (4 poles)

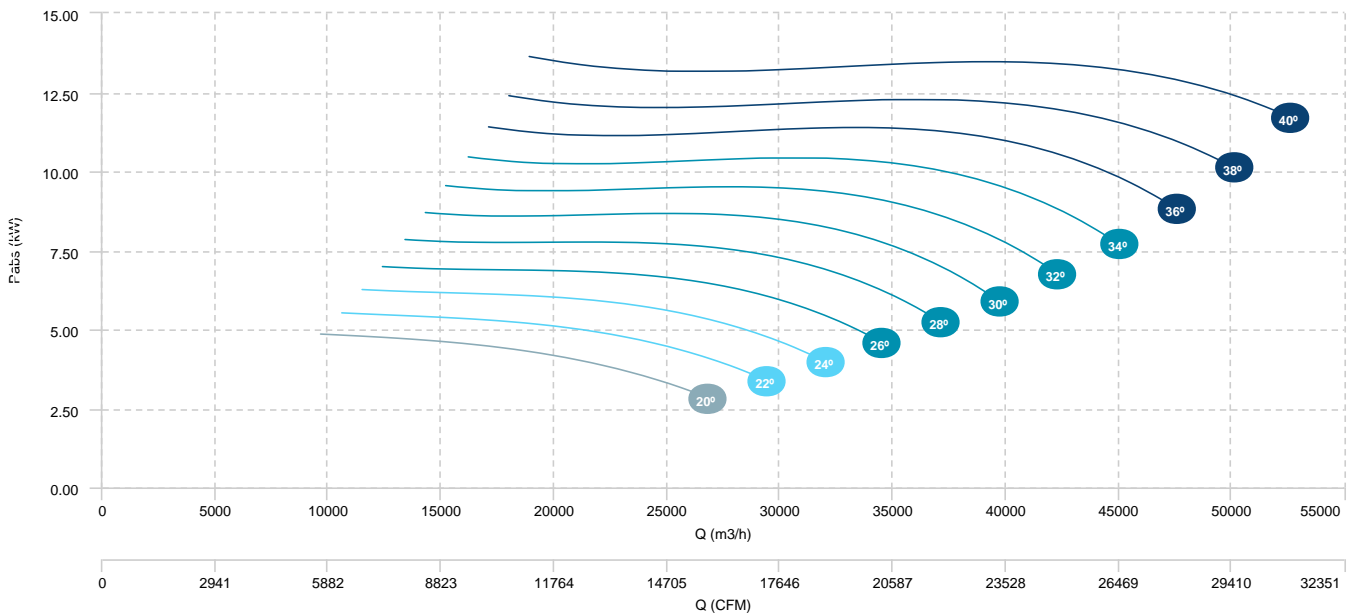

HMF 90 T4/T6 4,5/1,5kW (A3:8) F400	HMF 90 T4/T6 6/2,2kW (A3:8) F400	HMF 90 T4/T6 10/3,3kW (A3:8) F400
HMF 90 T4/T6 14/4,5kW (A3:8) F400		

AIR FLOW - PRESSURE (6 poles)

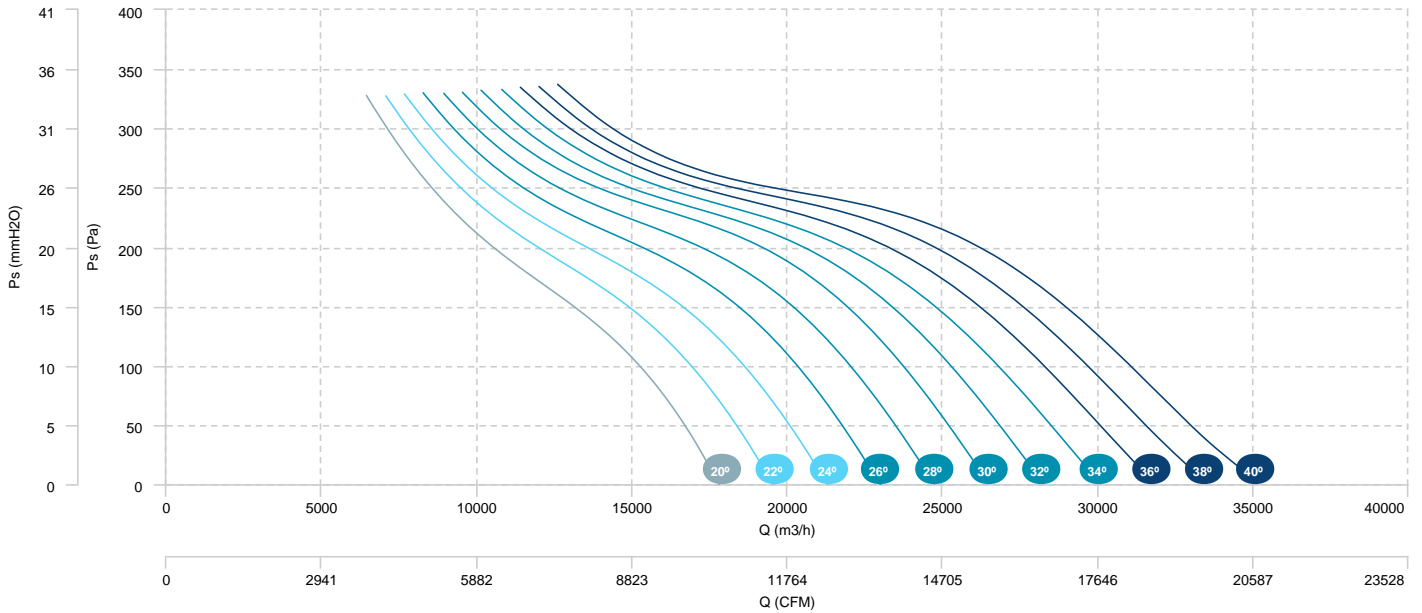

HMF 90 T4/T6 3/1kW (A3:4) F400	HMF 90 T4/T6 4,5/1,5kW (A3:4) F400	HMF 90 T4/T6 6/2,2kW (A3:4) F400
HMF 90 T4/T6 10/3,3kW (A3:4) F400		

AIR FLOW - PRESSURE (4 poles)

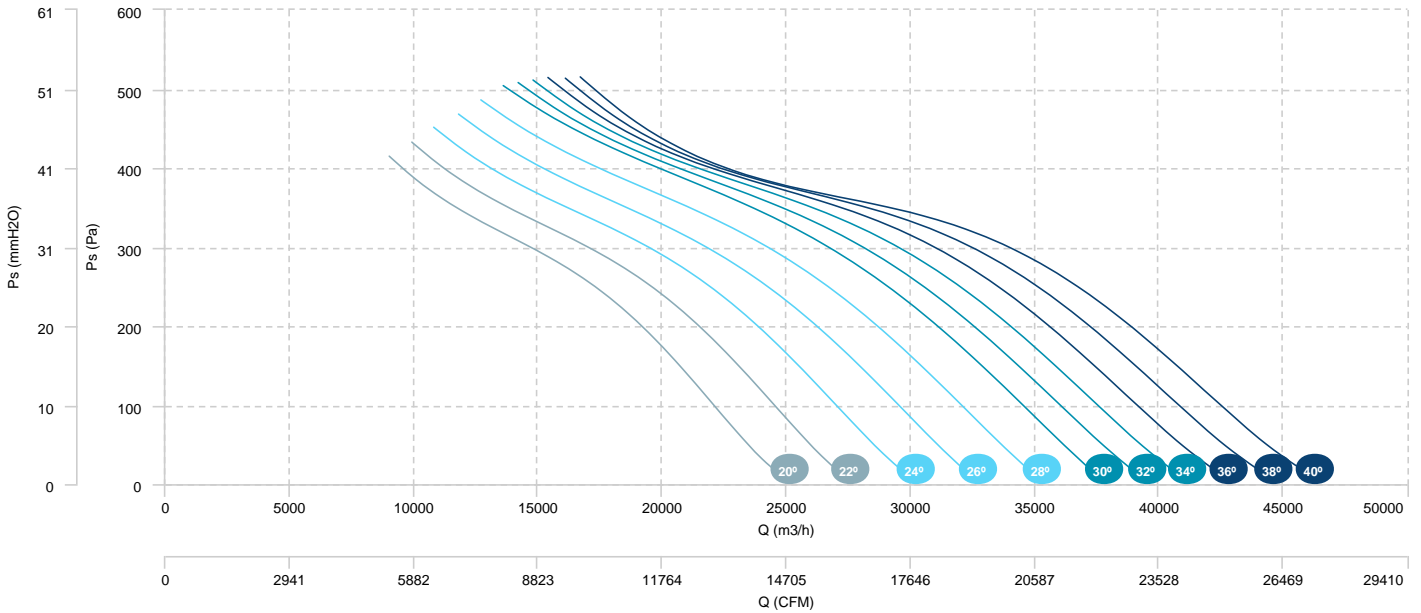

AIR FLOW - ABSORBED POWER (4 poles)

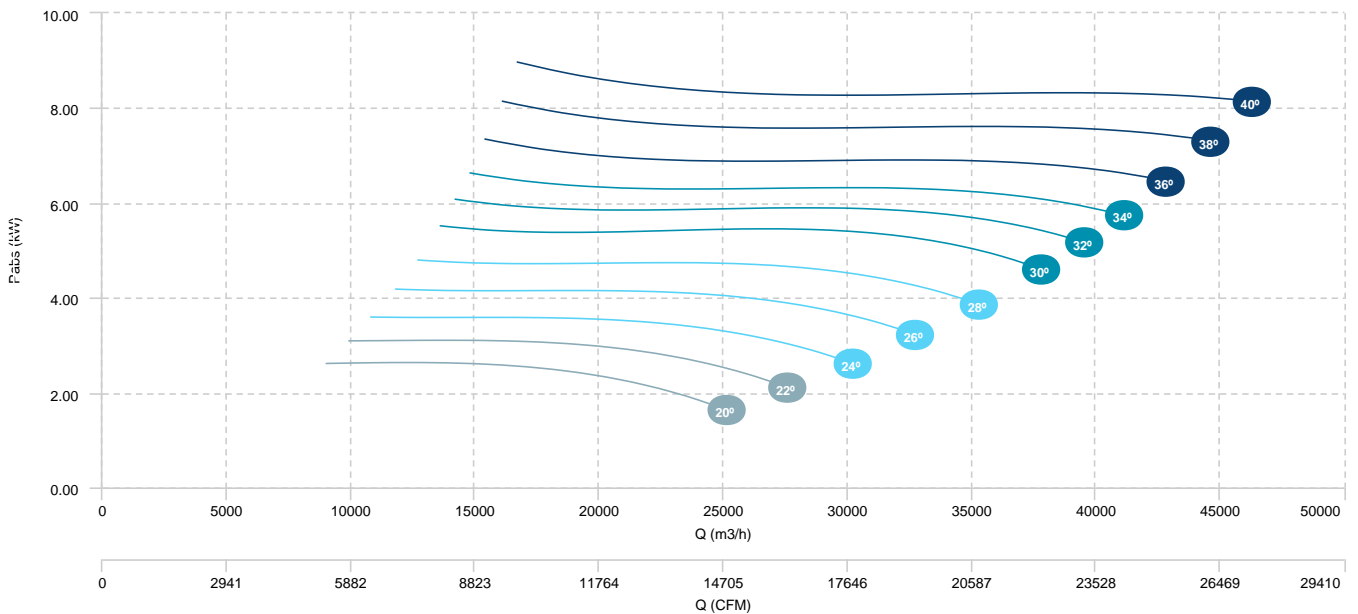

HMF 90 T4/T6 3/1kW (A3:4) F400	HMF 90 T4/T6 4,5/1,5kW (A3:4) F400	HMF 90 T4/T6 6/2,2kW (A3:4) F400
HMF 90 T4/T6 10/3,3kW (A3:4) F400		

AIR FLOW - PRESSURE (6 poles)

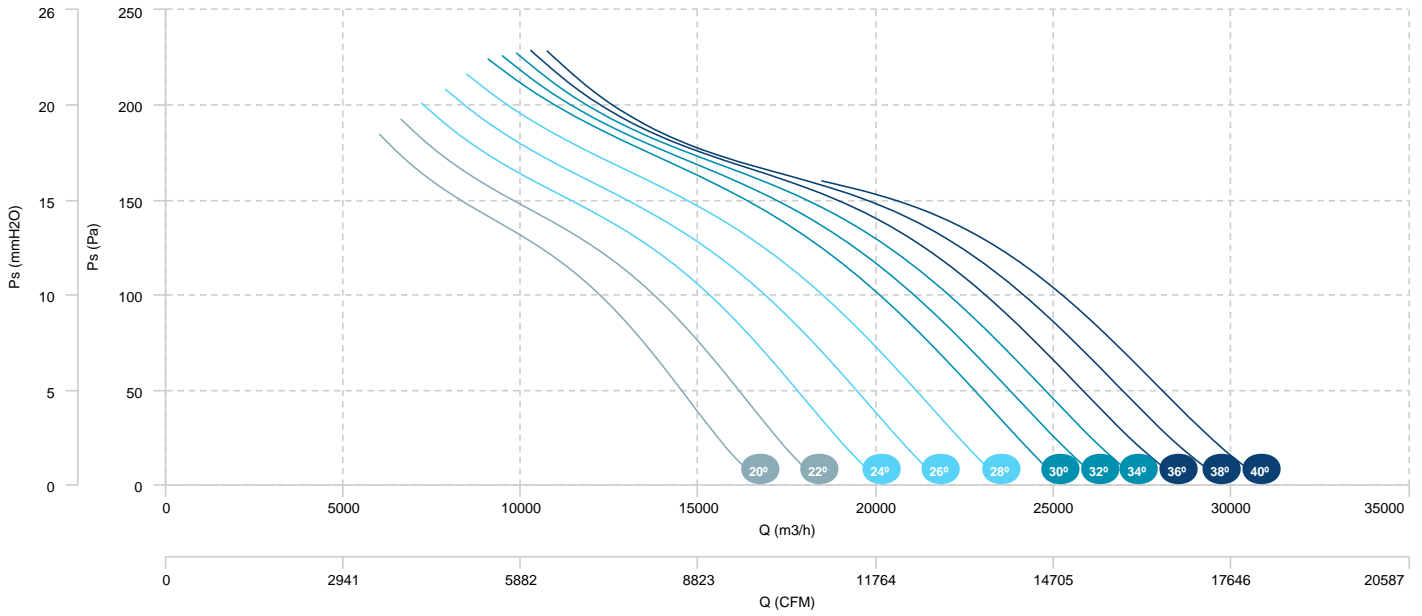

HMF 90 T4/T8 5,5/1,1kW (A3:8) F400	HMF 90 T4/T8 7,5/1,5kW (A3:8) F400	HMF 90 T4/T8 11/3kW (A3:8) F400
HMF 90 T4/T8 14/3,5kW (A3:8) F400		

AIR FLOW - PRESSURE (4 poles)

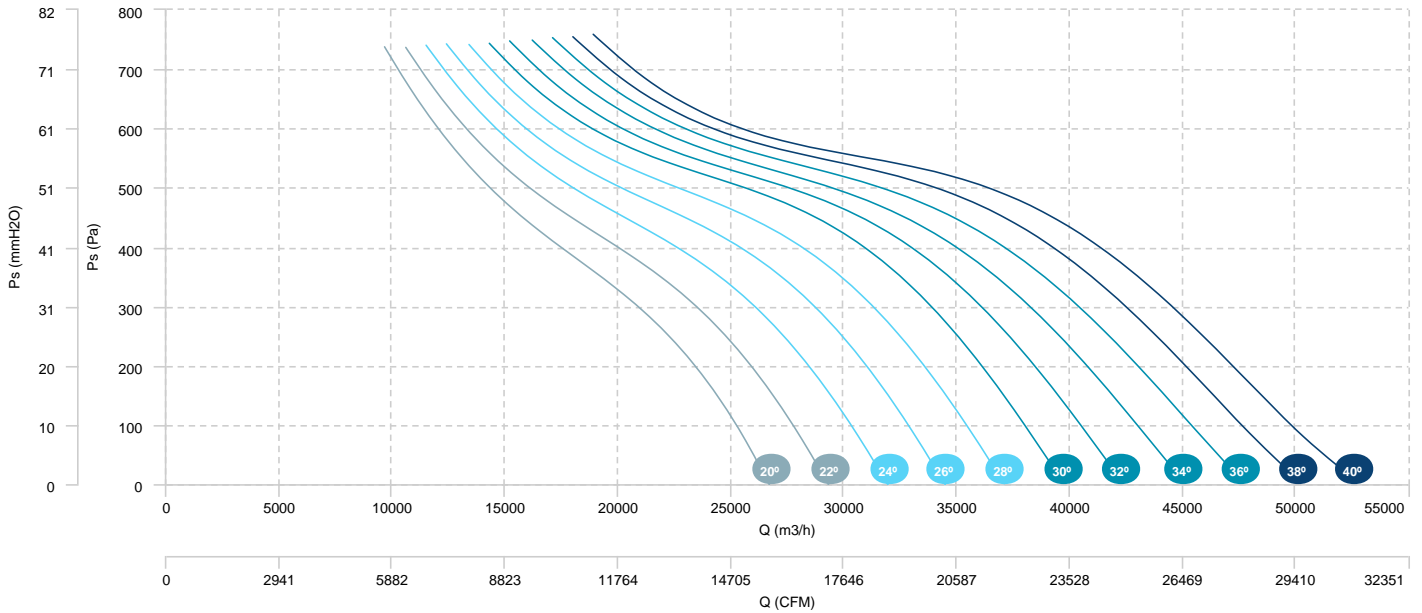

AIR FLOW - ABSORBED POWER (4 poles)

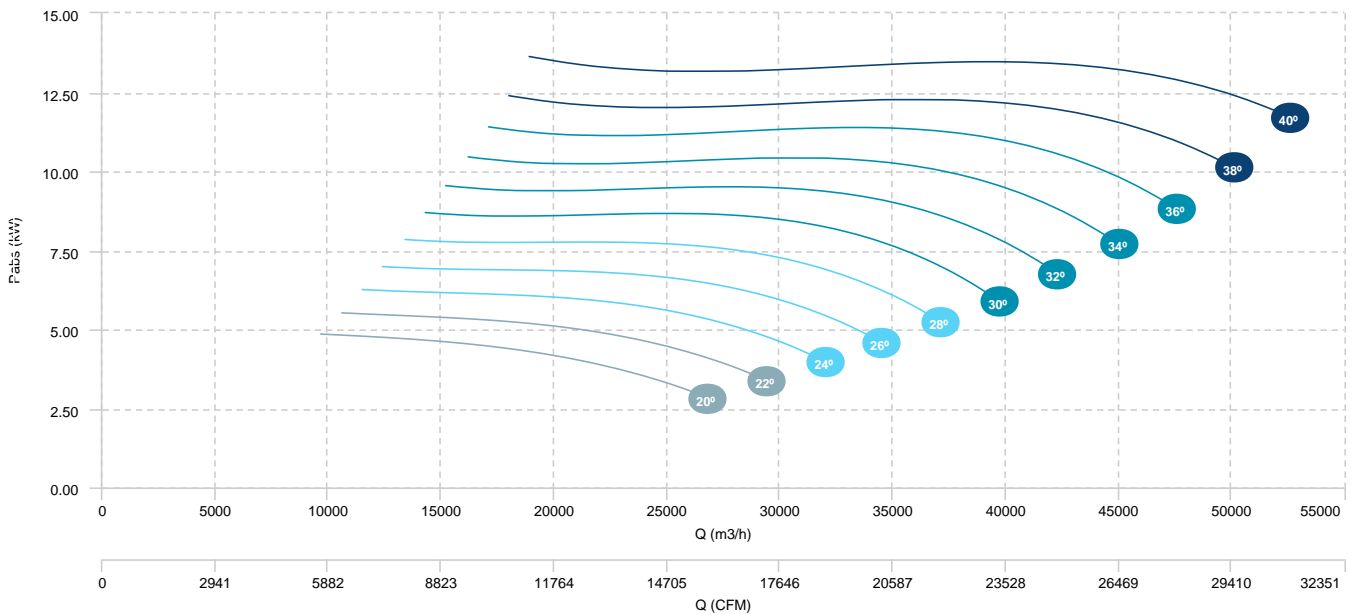

- HMF 90 T4/T8 5,5/1,1kW (A3:8) F400
 - HMF 90 T4/T8 7,5/1,5kW (A3:8) F400
 - HMF 90 T4/T8 11/3kW (A3:8) F400
- HMF 90 T4/T8 14/3,5kW (A3:8) F400

AIR FLOW - PRESSURE (8 poles)

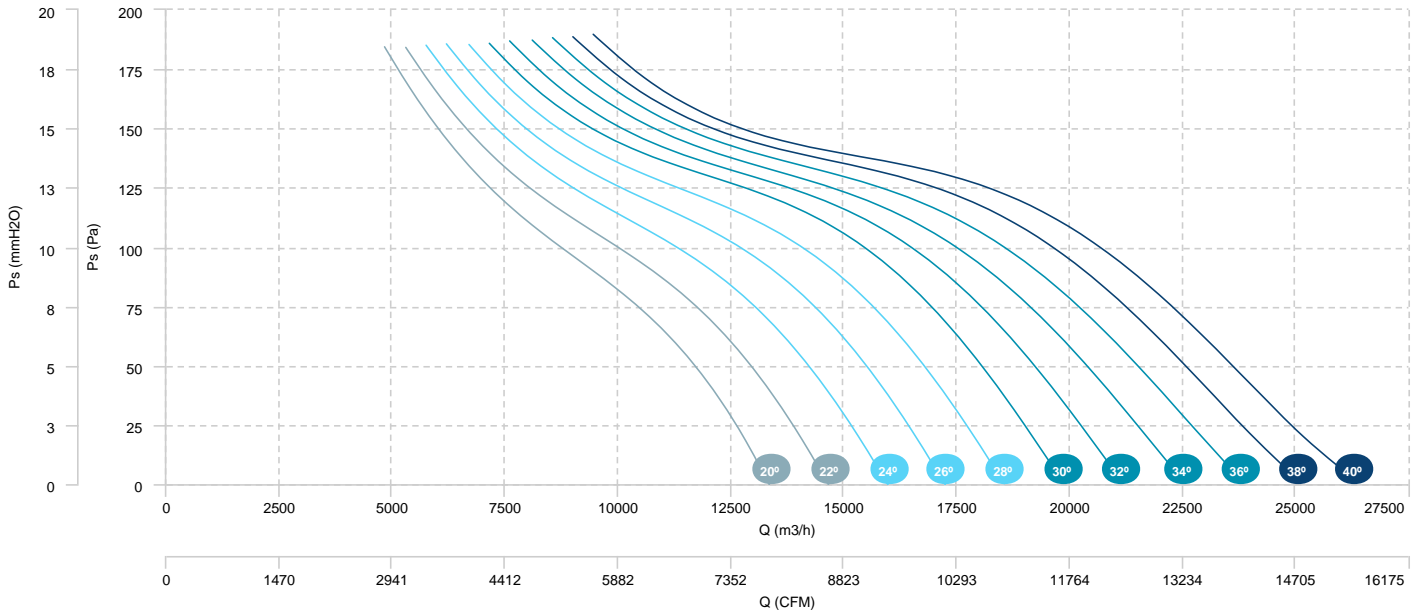

HMF 90 T4/T8 2,8/0,7kW (A3:4) F400	HMF 90 T4/T8 4/0,75kW (A3:4) F400	HMF 90 T4/T8 5,5/1,1kW (A3:4) F400
HMF 90 T4/T8 7,5/1,5kW (A3:4) F400	HMF 90 T4/T8 11/3kW (A3:4) F400	

AIR FLOW - PRESSURE (4 poles)

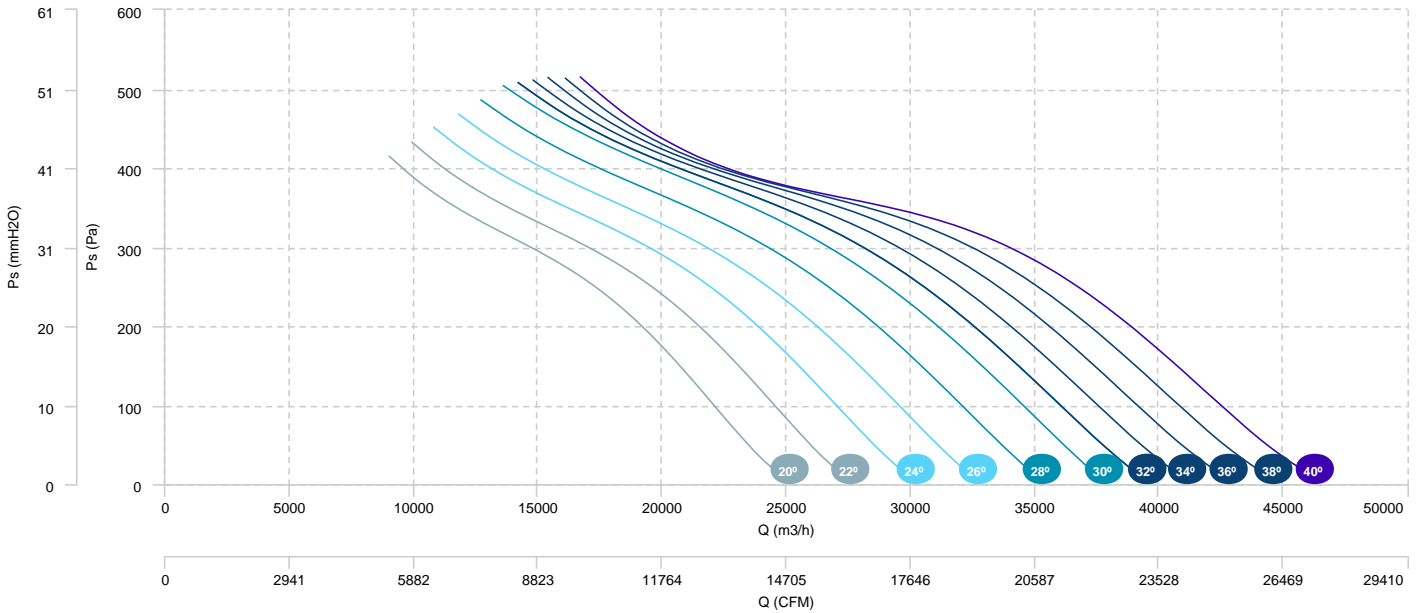

AIR FLOW - ABSORBED POWER (4 poles)

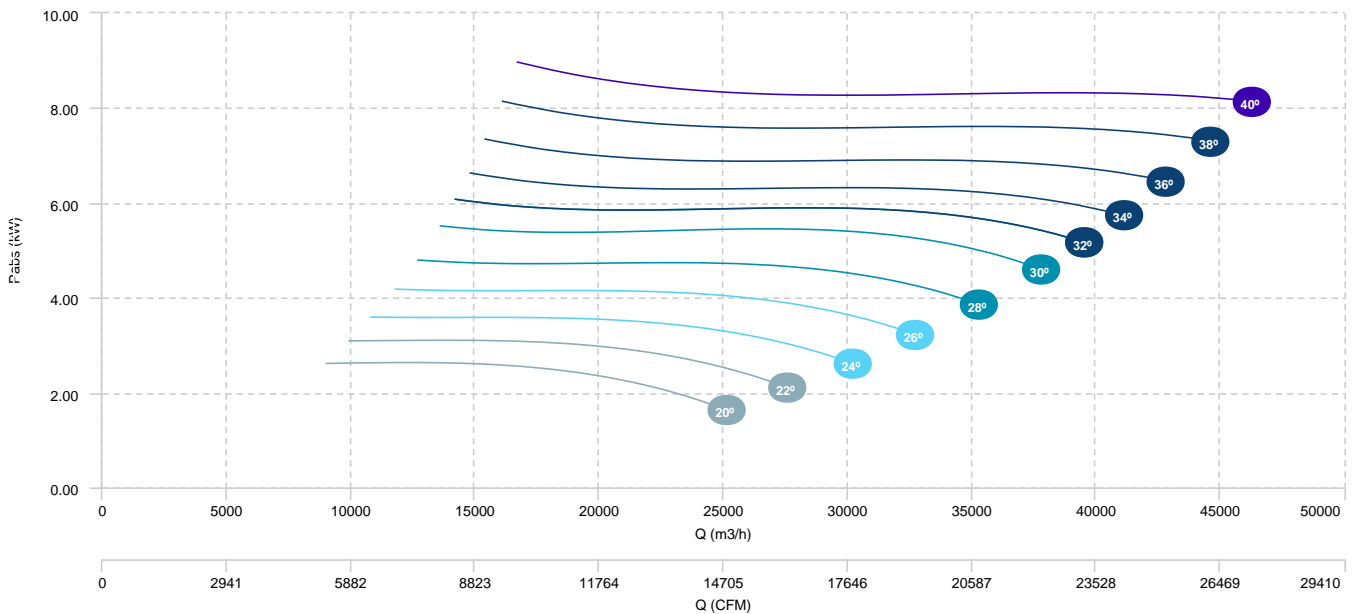

HMF 90 T4/T8 2,8/0,7kW (A3:4) F400	HMF 90 T4/T8 4/0,75kW (A3:4) F400	HMF 90 T4/T8 5,5/1,1kW (A3:4) F400
HMF 90 T4/T8 7,5/1,5kW (A3:4) F400	HMF 90 T4/T8 11/3kW (A3:4) F400	

AIR FLOW - PRESSURE (8 poles)

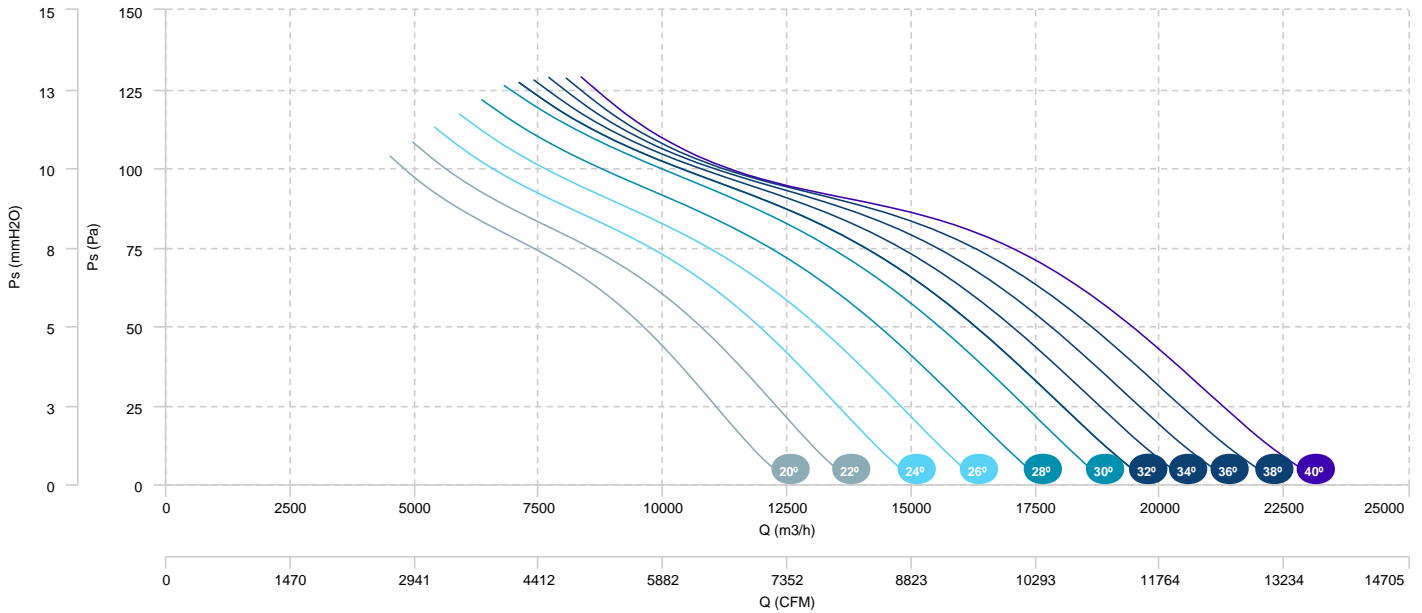

HMF 100 T4 7,5kW (A3:8) F400	HMF 100 T4 11kW (A3:8) F400	HMF 100 T4 15kW (A3:8) F400
HMF 100 T4 18,5kW (A3:8) F400	HMF 100 T4 22kW (A3:8) F400	

AIR FLOW - PRESSURE

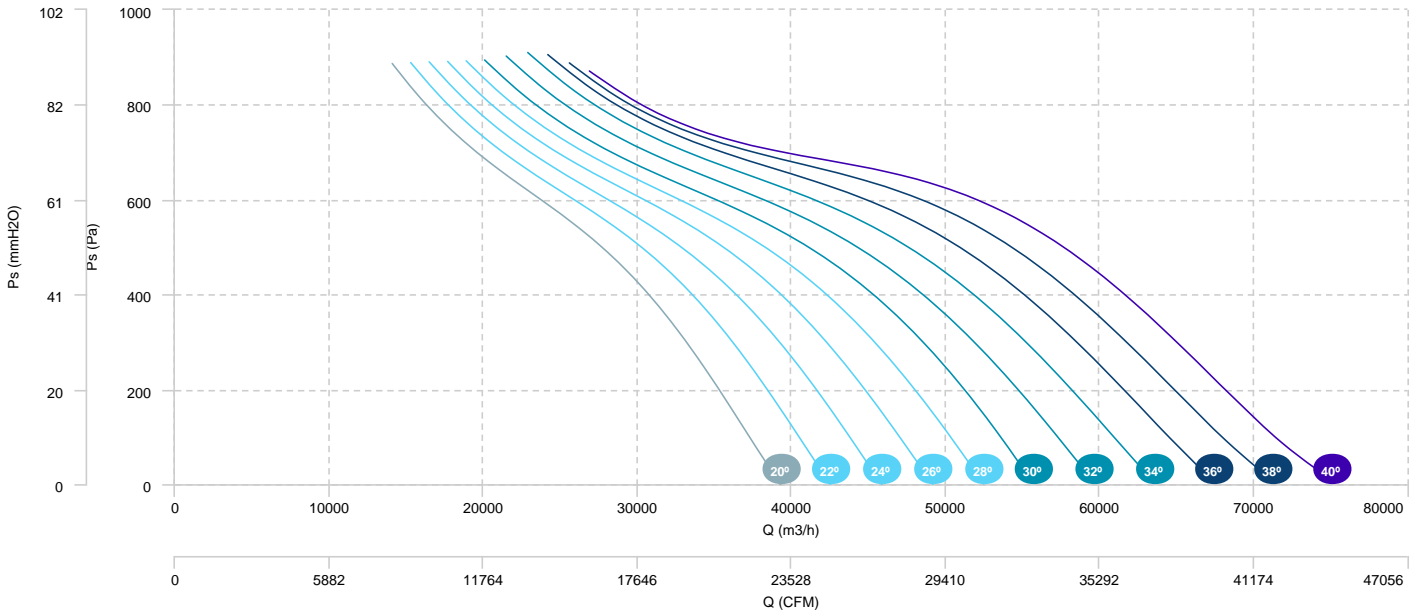

AIR FLOW - ABSORBED POWER

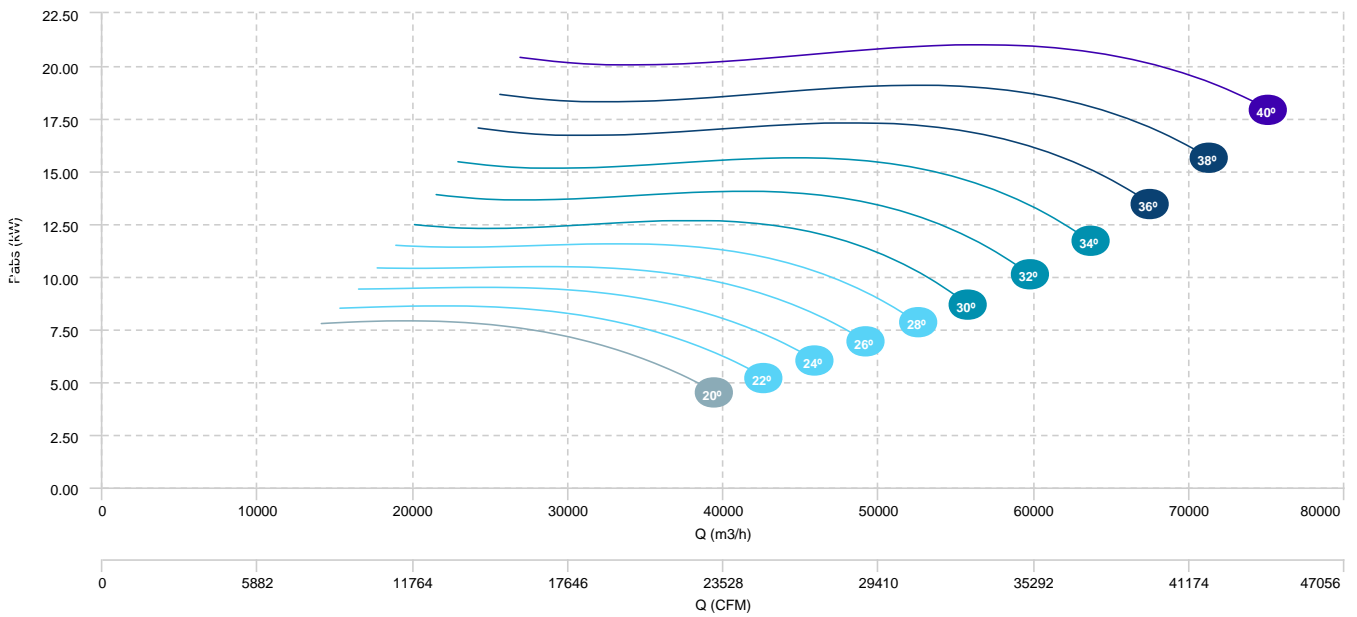

HMF 100 T4 5,5kW (A3:4) F400	HMF 100 T4 7,5kW (A3:4) F400	HMF 100 T4 11kW (A3:4) F400
HMF 100 T4 15kW (A3:4) F400		

AIR FLOW - PRESSURE

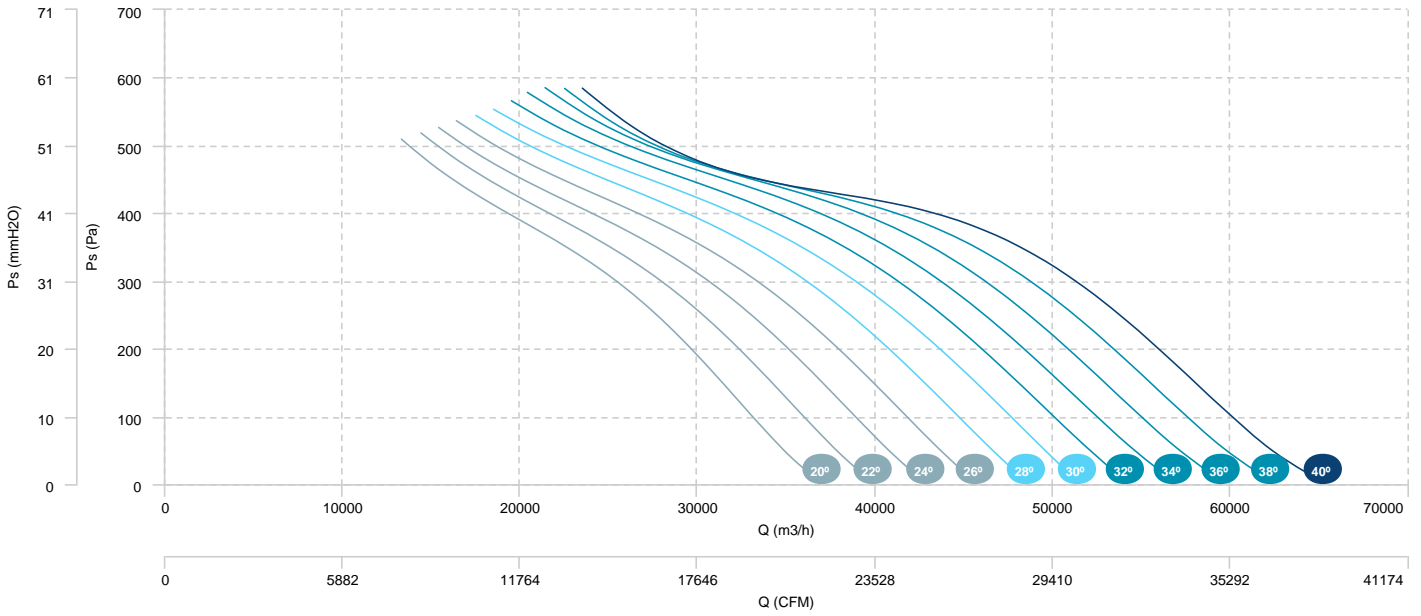

AIR FLOW - ABSORBED POWER

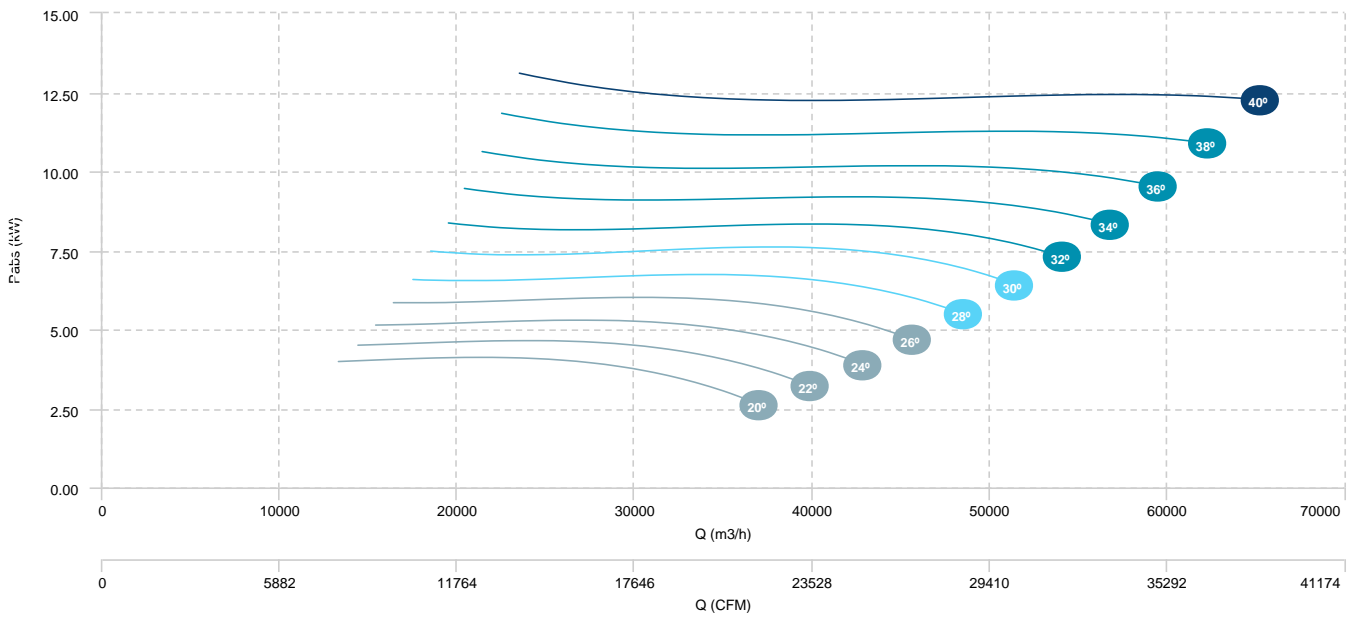

HMF 100 T6 2,2kW (A3:8) F400	HMF 100 T6 3kW (A3:8) F400	HMF 100 T6 4kW (A3:8) F400
HMF 100 T6 5,5kW (A3:8) F400		

AIR FLOW - PRESSURE

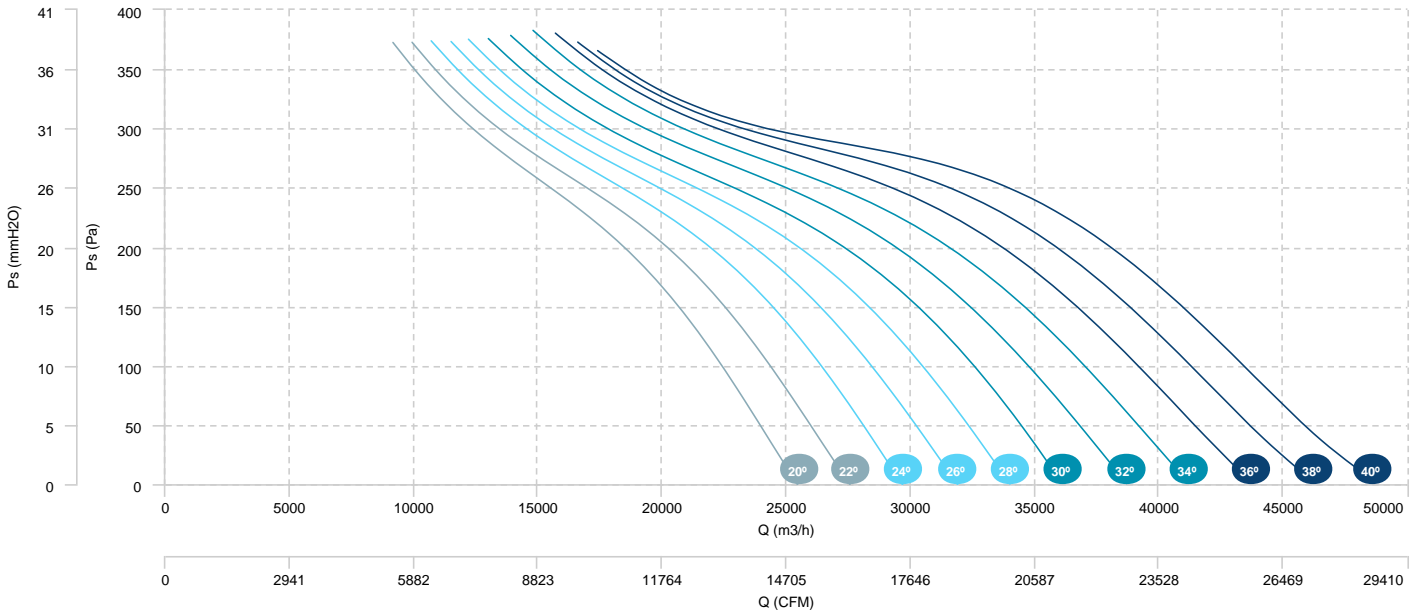

AIR FLOW - ABSORBED POWER

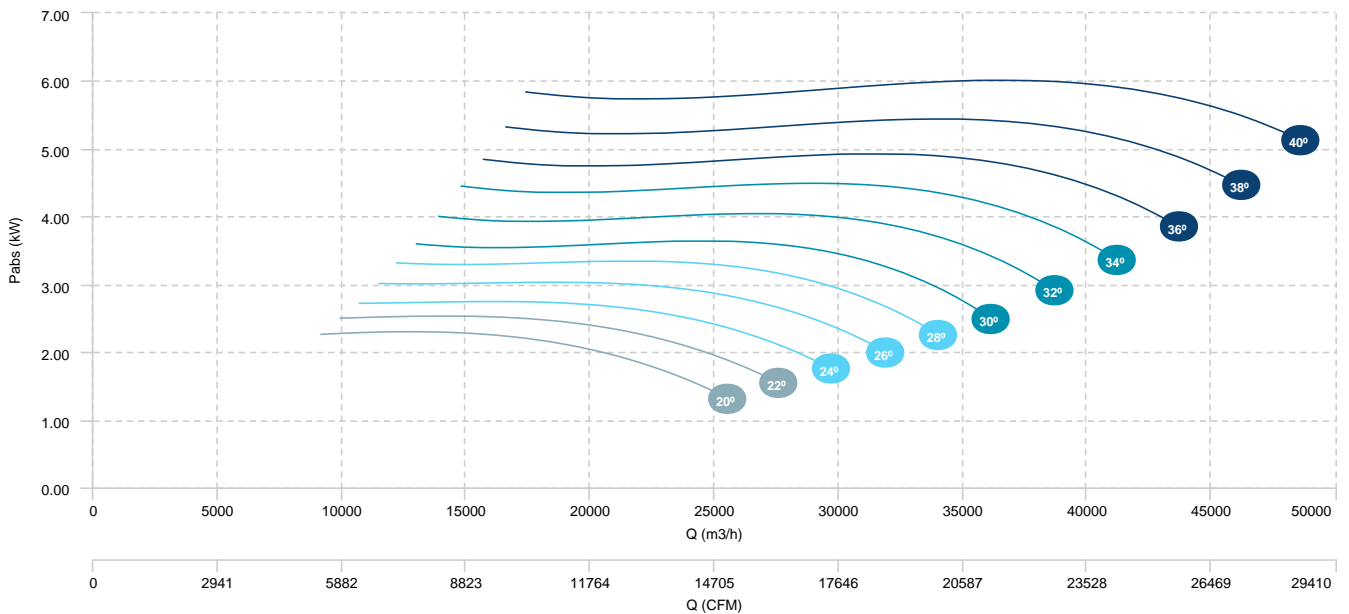

HMF 100 T6 1,5kW (A3:4) F400	HMF 100 T6 2,2kW (A3:4) F400	HMF 100 T6 3kW (A3:4) F400
HMF 100 T6 4kW (A3:4) F400		

AIR FLOW - PRESSURE

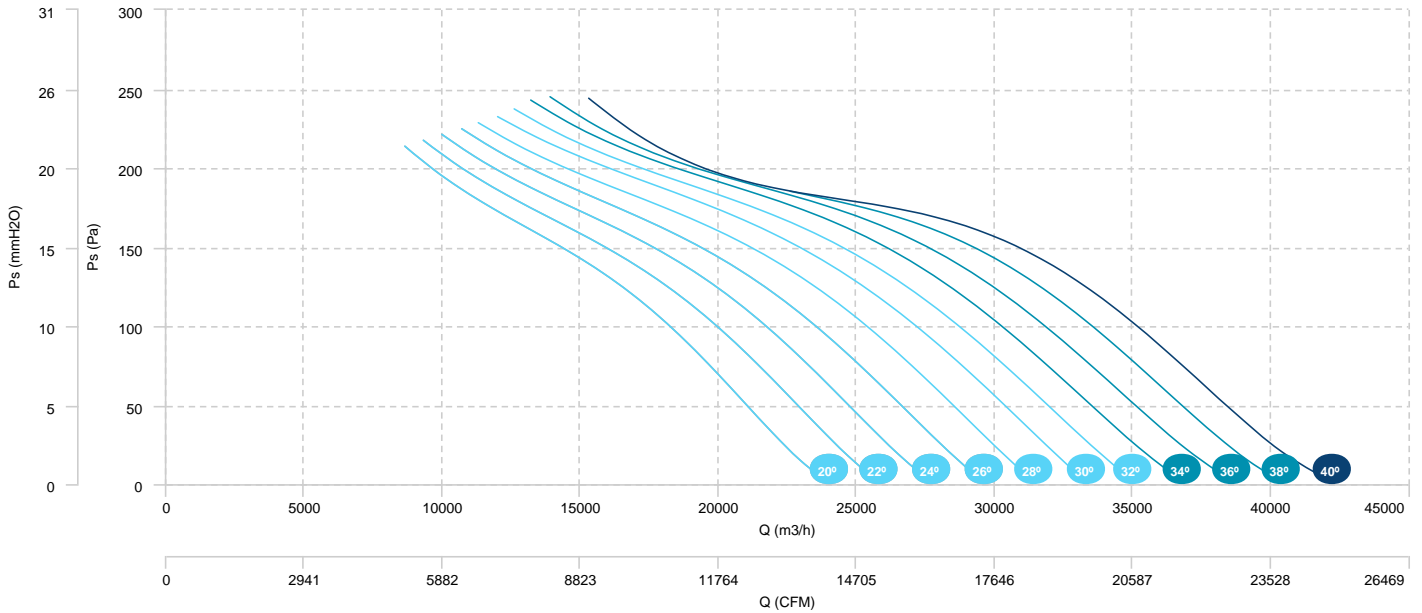

AIR FLOW - ABSORBED POWER

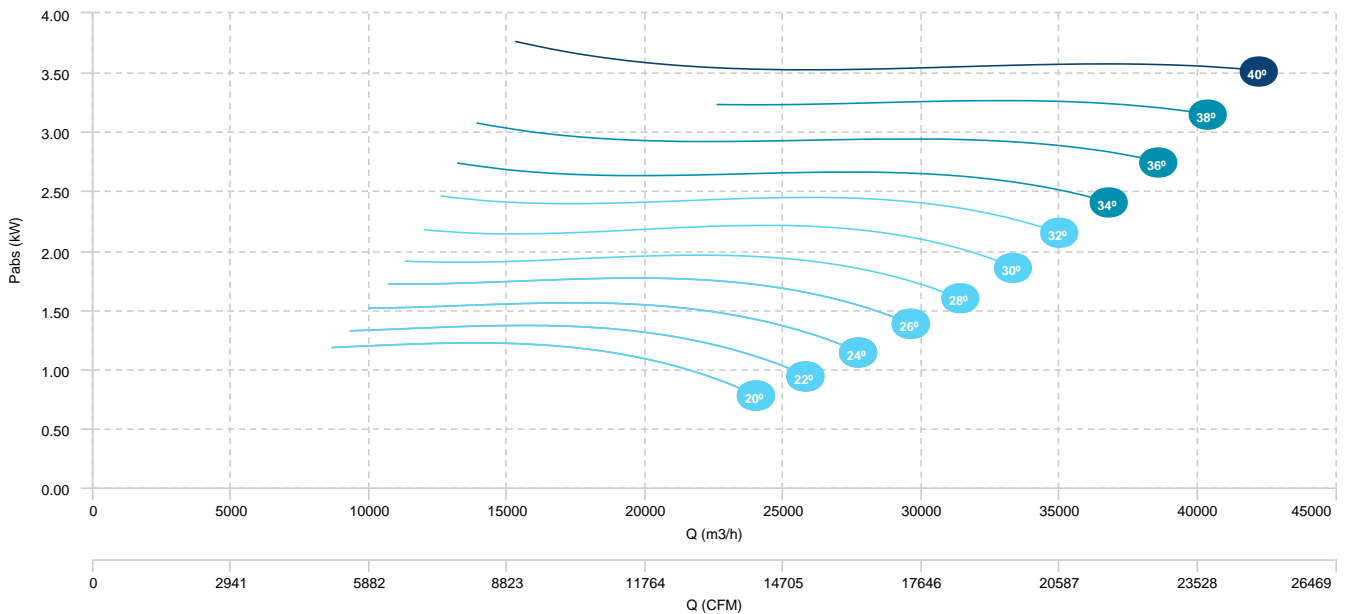

HMF 100 T4/T6 10/3,3kW (A3:8) F400	HMF 100 T4/T6 14/4,5kW (A3:8) F400	HMF 100 T4/T6 16/6,5kW (A3:8) F400
HMF 100 T4/T6 20/8,5kW (A3:8) F400		

AIR FLOW - PRESSURE (4 poles)

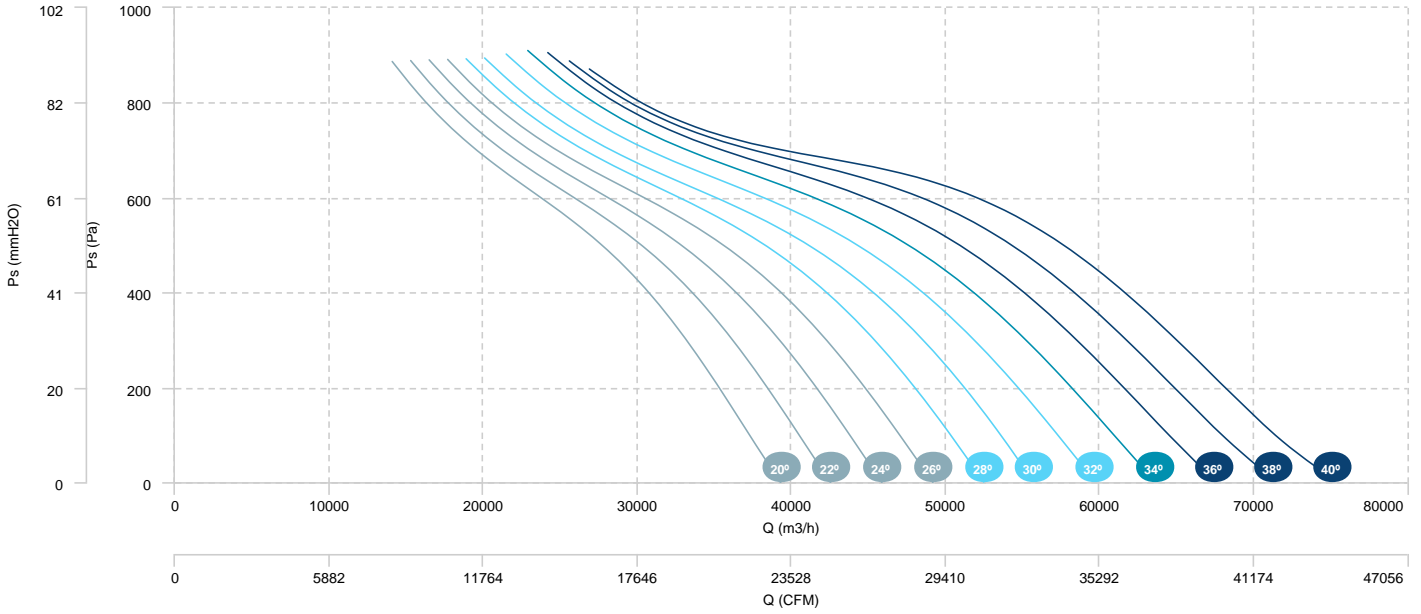

AIR FLOW - ABSORBED POWER (4 poles)

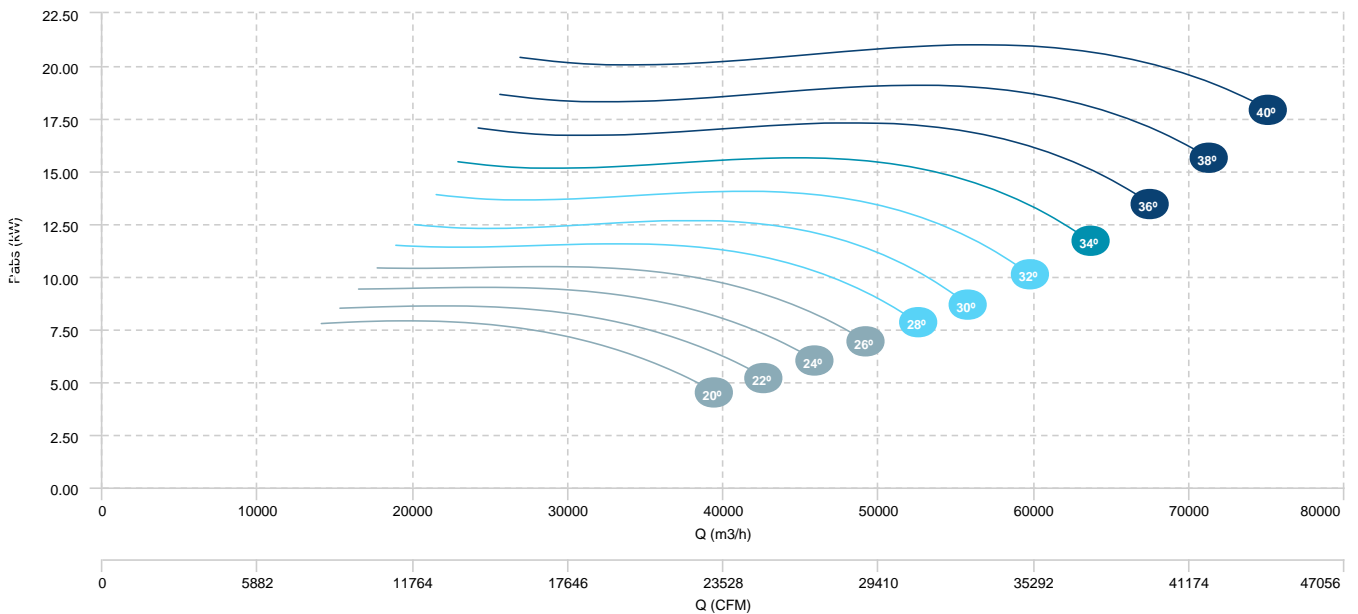

HMF 100 T4/T6 10/3,3kW (A3:8) F400	HMF 100 T4/T6 14/4,5kW (A3:8) F400	HMF 100 T4/T6 16/6,5kW (A3:8) F400
HMF 100 T4/T6 20/8,5kW (A3:8) F400		

AIR FLOW - PRESSURE (6 poles)

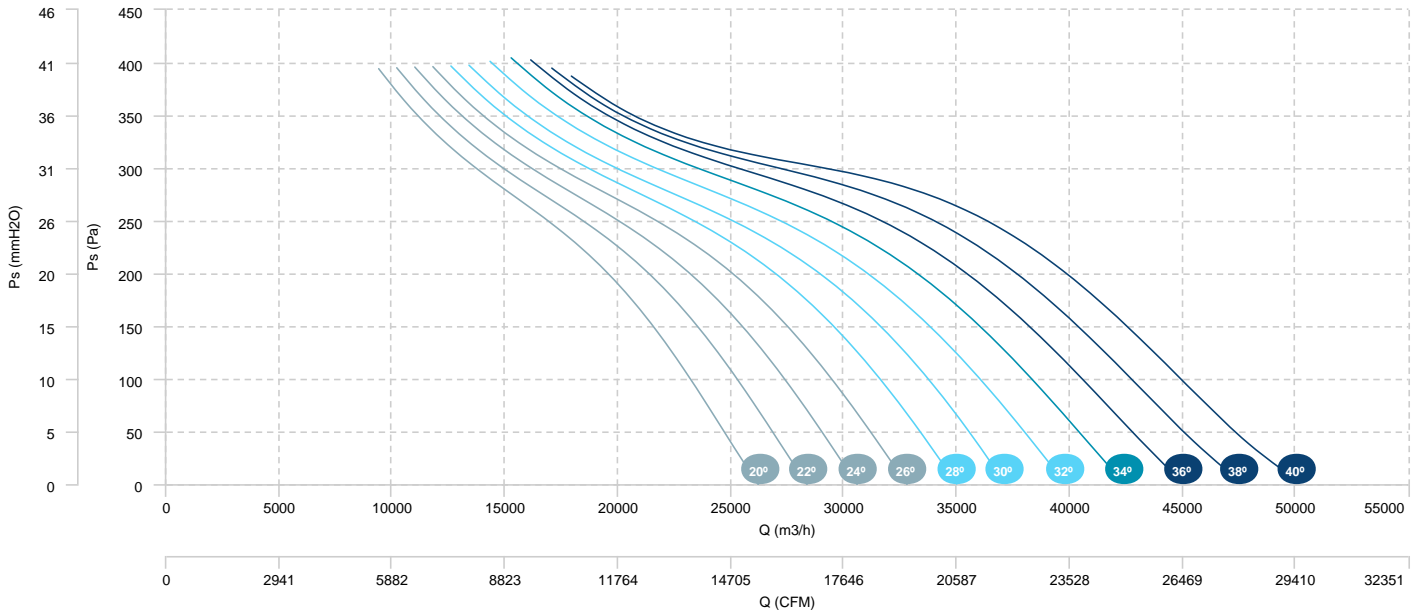

HMF 100 T4/T6 4,5/1,5kW (A3:4) F400	HMF 100 T4/T6 6/2,2kW (A3:4) F400	HMF 100 T4/T6 10/3,3kW (A3:4) F400
HMF 100 T4/T6 14/4,5kW (A3:4) F400		

AIR FLOW - PRESSURE (4 poles)

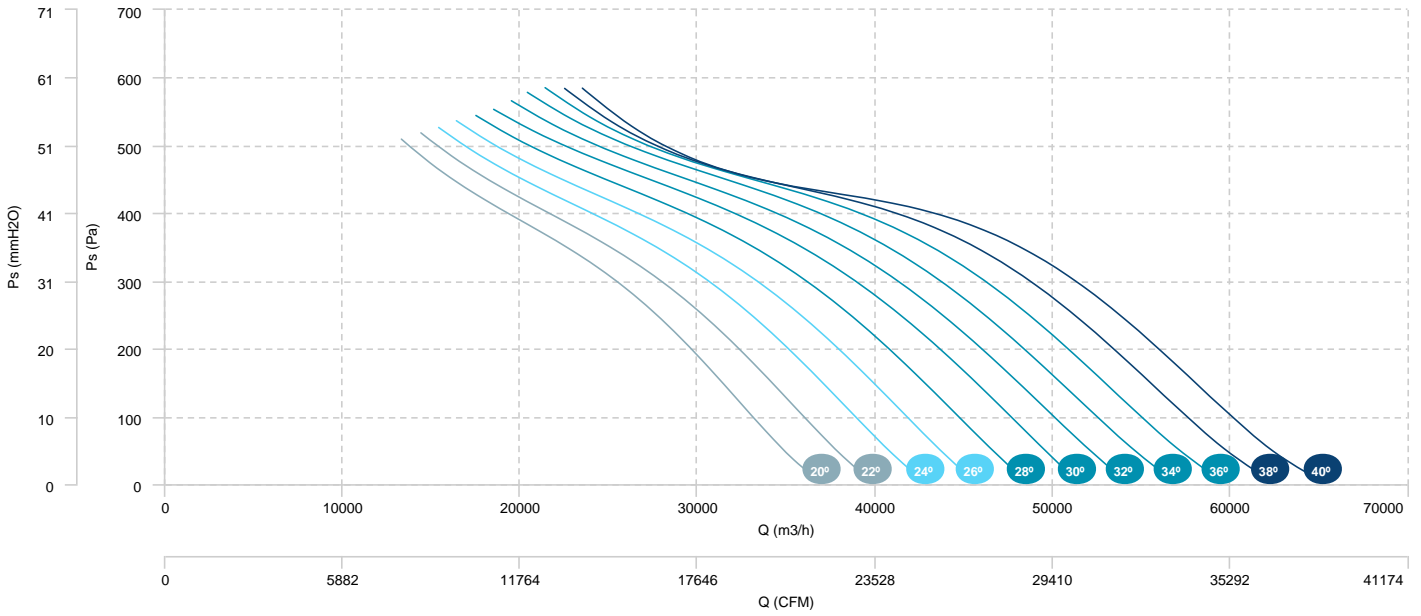

AIR FLOW - ABSORBED POWER (4 poles)

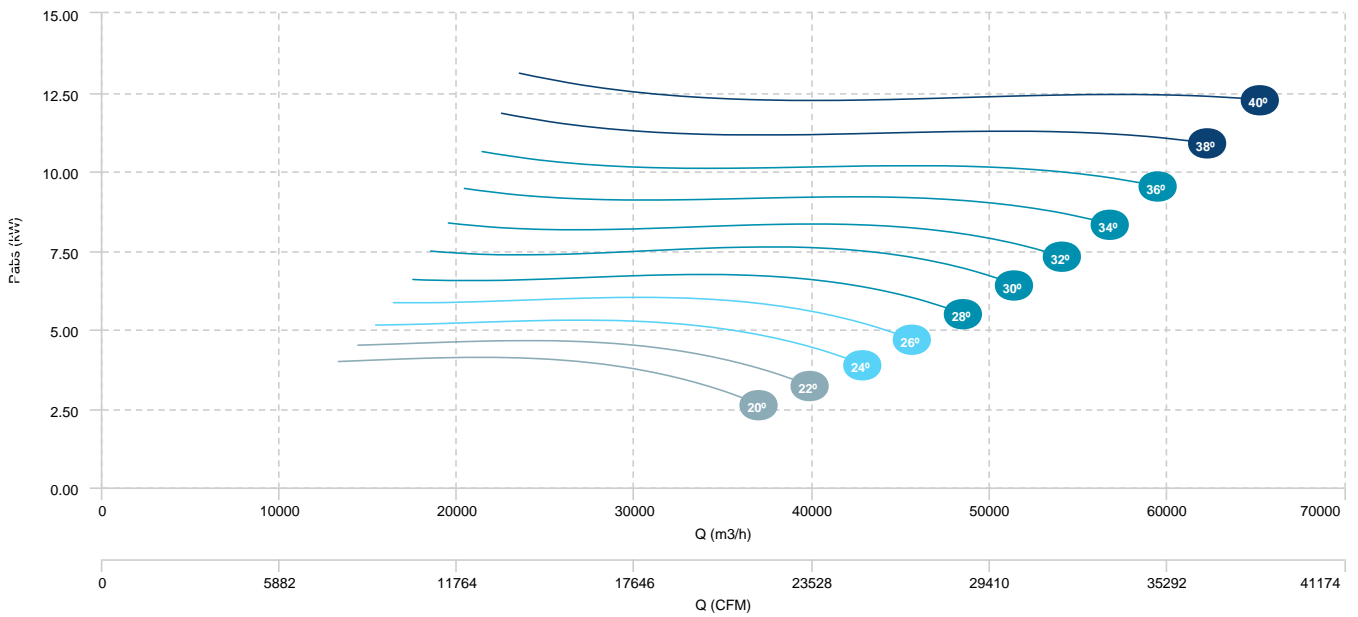

HMF 100 T4/T6 4,5/1,5kW (A3:4) F400	HMF 100 T4/T6 6/2,2kW (A3:4) F400	HMF 100 T4/T6 10/3,3kW (A3:4) F400
HMF 100 T4/T6 14/4,5kW (A3:4) F400		

AIR FLOW - PRESSURE (6 poles)

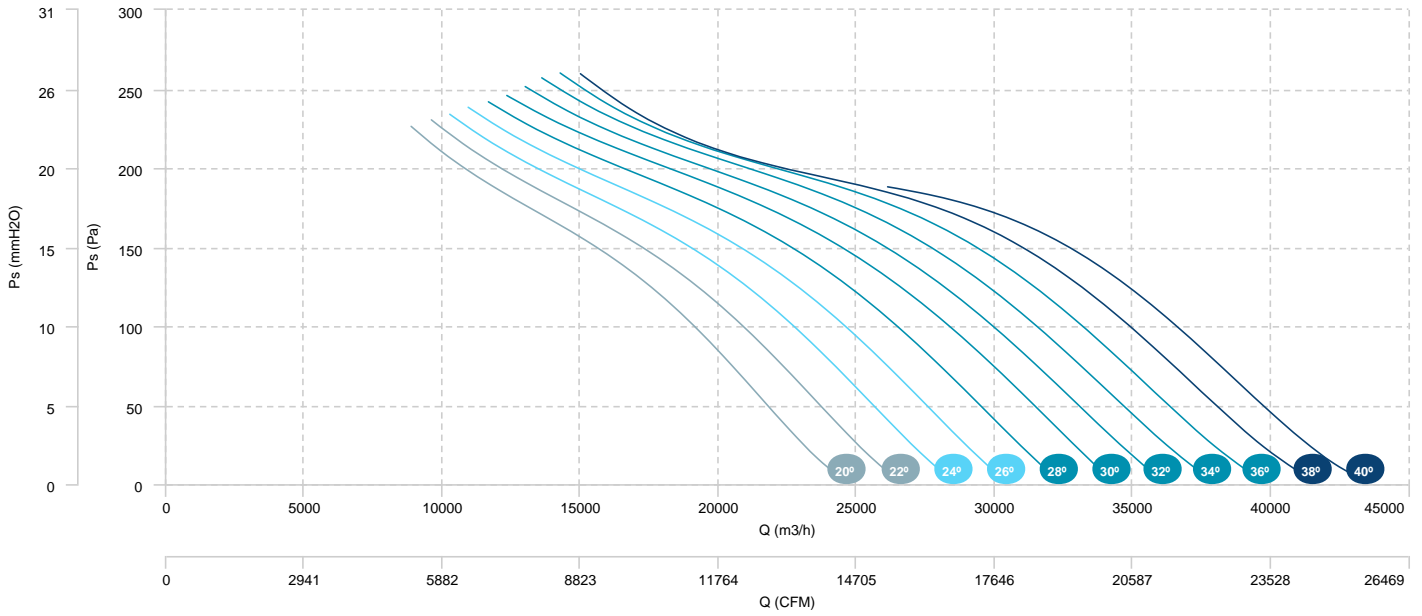

HMF 100 T4/T8 5,5/1,1kW (A3:4) F400	HMF 100 T4/T8 7,5/1,5kW (A3:4) F400	HMF 100 T4/T8 11/3kW (A3:4) F400
HMF 100 T4/T8 14/3,5kW (A3:4) F400		

AIR FLOW - PRESSURE (4 poles)

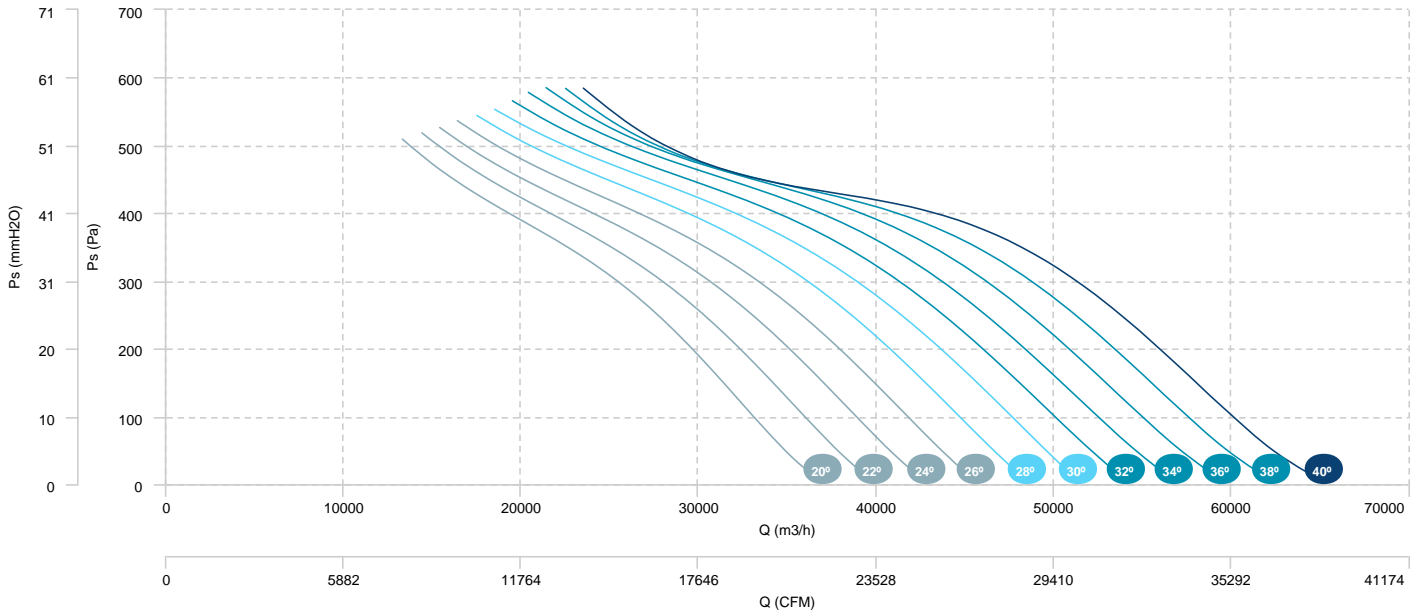

AIR FLOW - ABSORBED POWER (4 poles)

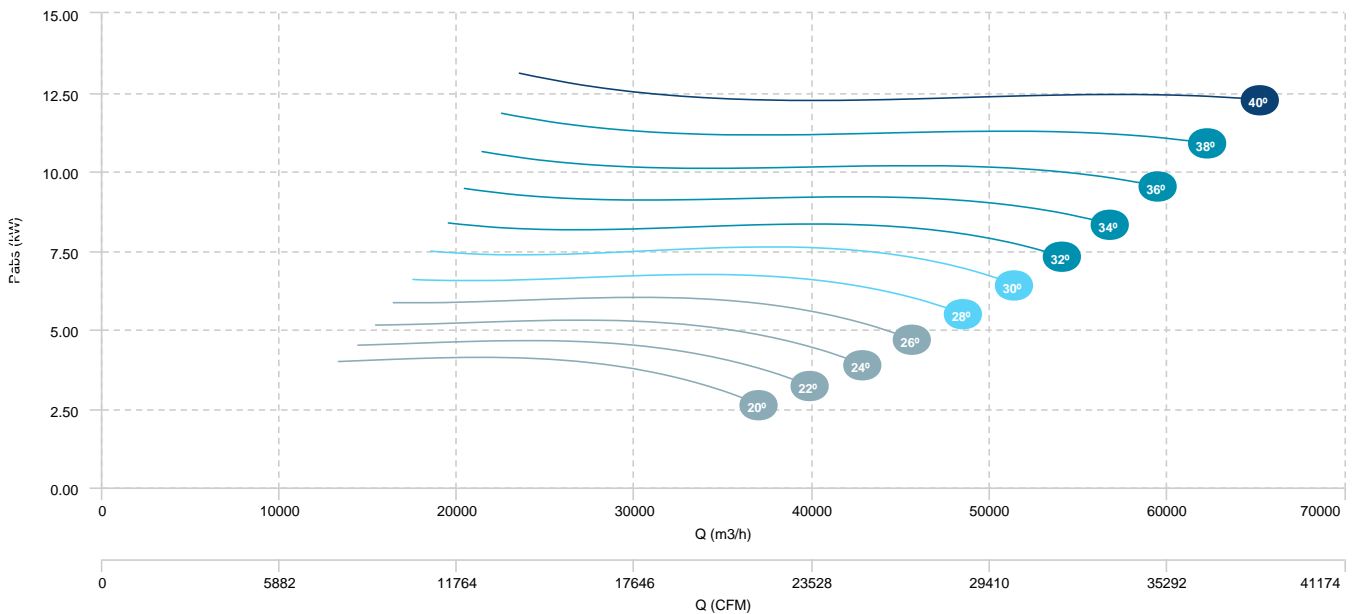

HMF 100 T4/T8 5,5/1,1kW (A3:4) F400	HMF 100 T4/T8 7,5/1,5kW (A3:4) F400	HMF 100 T4/T8 11/3kW (A3:4) F400
HMF 100 T4/T8 14/3,5kW (A3:4) F400		

AIR FLOW - PRESSURE (8 poles)

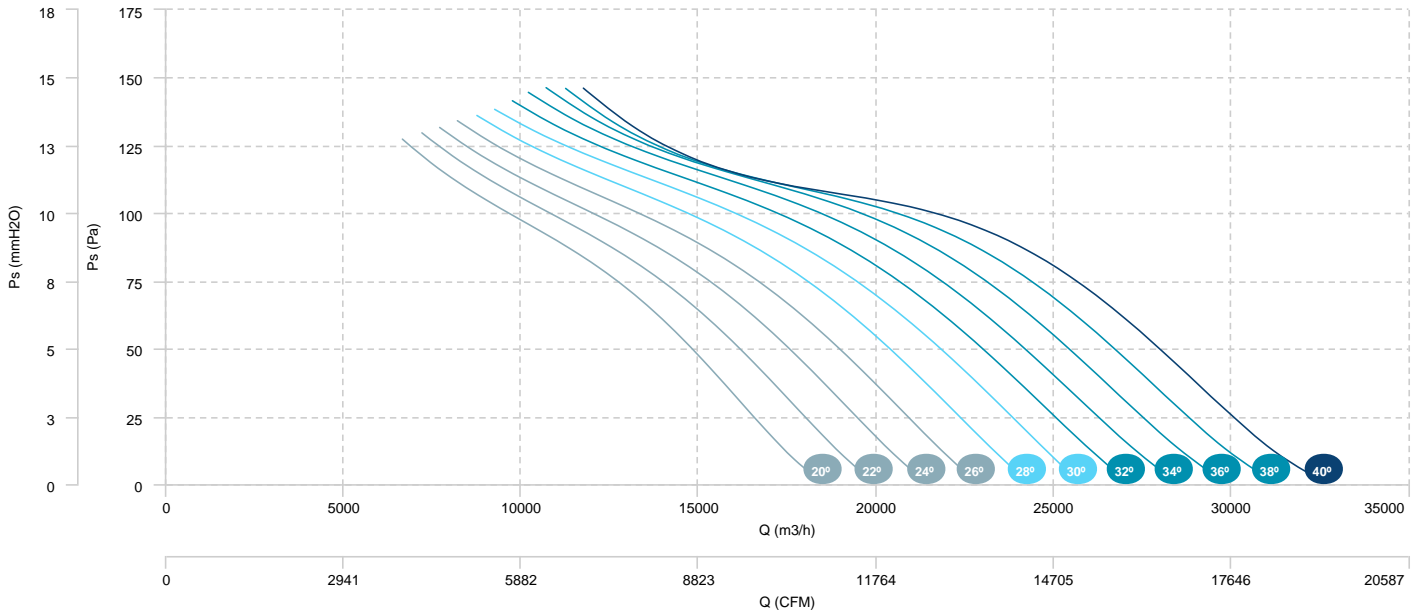

HMF 100 T4/T8 7,5/1,5kW (A3:8) F400	HMF 100 T4/T8 11/3kW (A3:8) F400	HMF 100 T4/T8 14/3,5kW (A3:8) F400
HMF 100 T4/T8 17/4,3kW (A3:8) F400	HMF 100 T4/T8 20/5kW (A3:8) F400	

AIR FLOW - PRESSURE (4 poles)

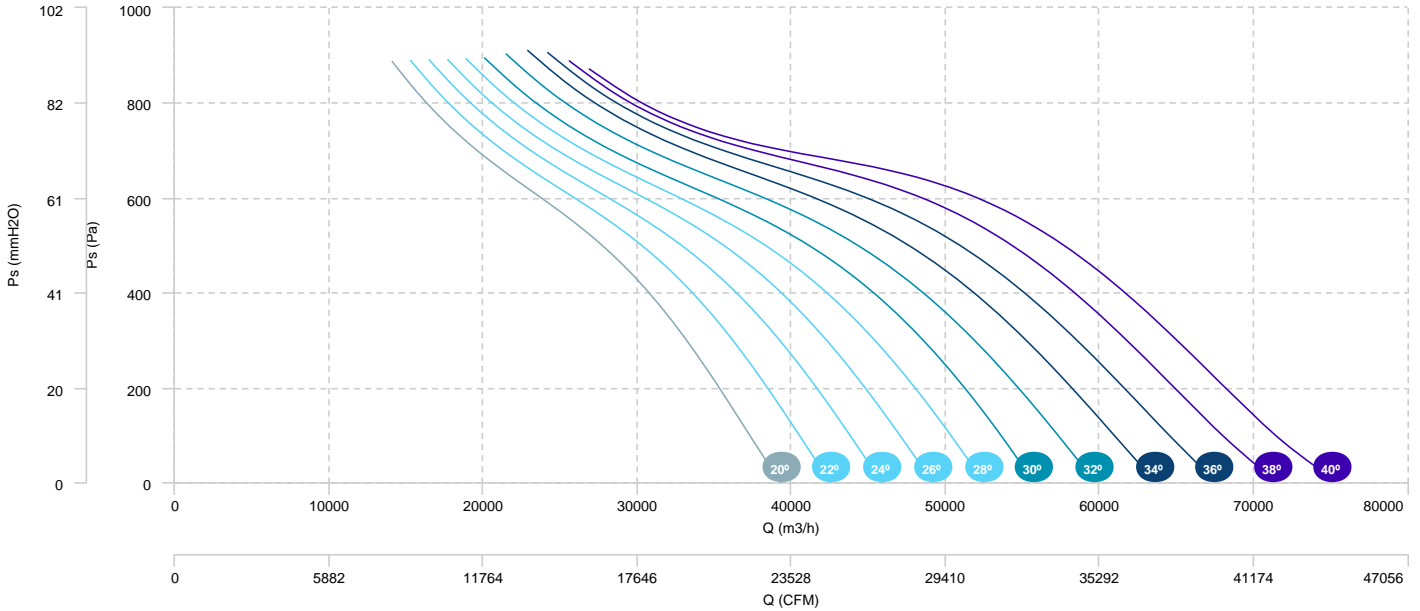

AIR FLOW - ABSORBED POWER (4 poles)

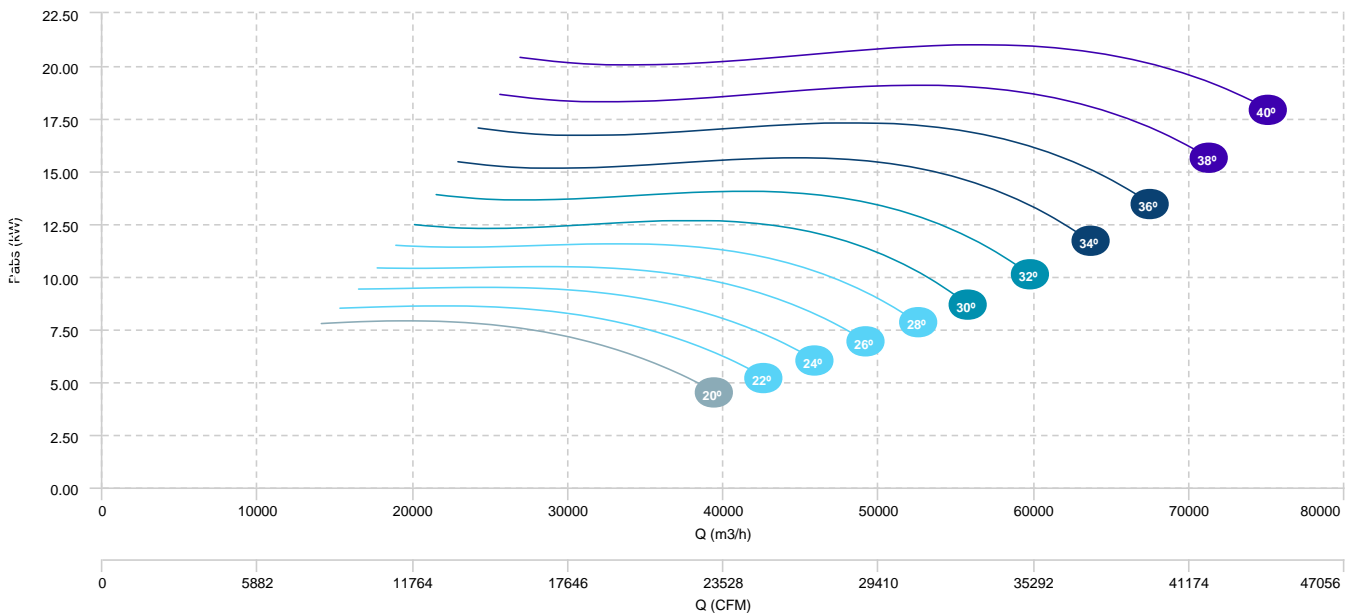

HMF 100 T4/T8 7,5/1,5kW (A3:8) F400	HMF 100 T4/T8 11/3kW (A3:8) F400	HMF 100 T4/T8 14/3,5kW (A3:8) F400
HMF 100 T4/T8 17/4,3kW (A3:8) F400	HMF 100 T4/T8 20/5kW (A3:8) F400	

AIR FLOW - PRESSURE (8 poles)

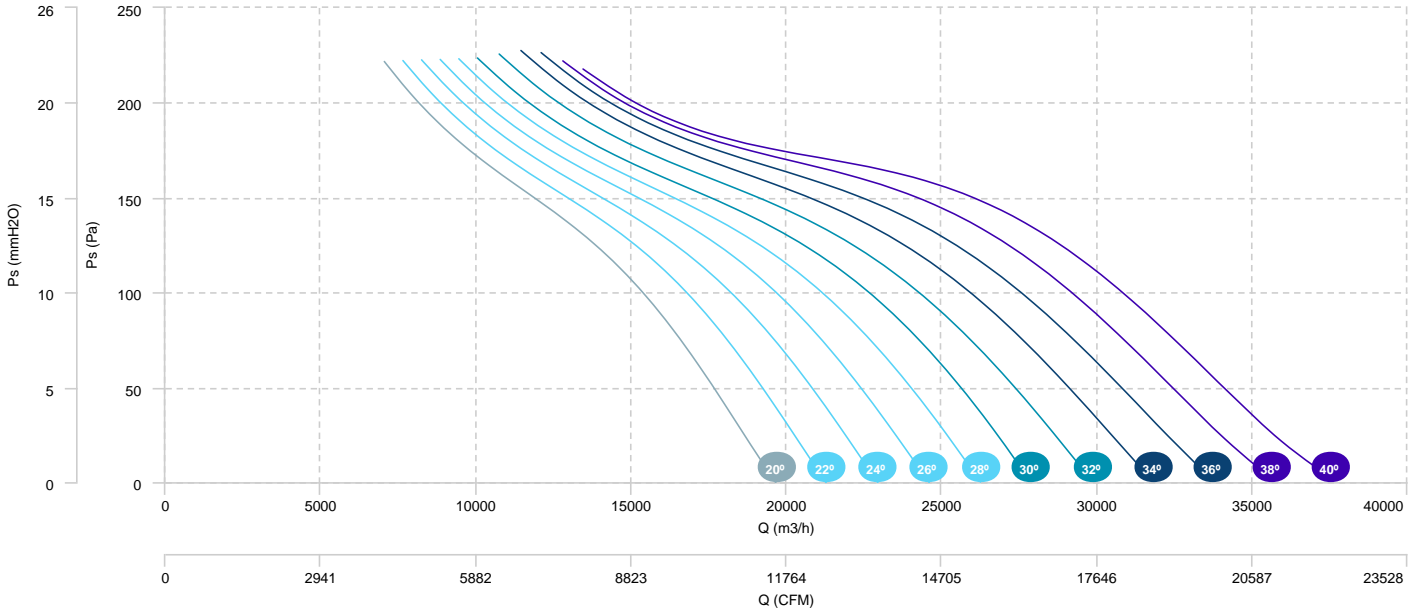

HMF 112 T4 11kW (A3:8) F400	HMF 112 T4 15kW (A3:8) F400	HMF 112 T4 18,5kW (A3:8) F400
HMF 112 T4 22kW (A3:8) F400	HMF 112 T4 30kW (A3:8) F400	

AIR FLOW - PRESSURE

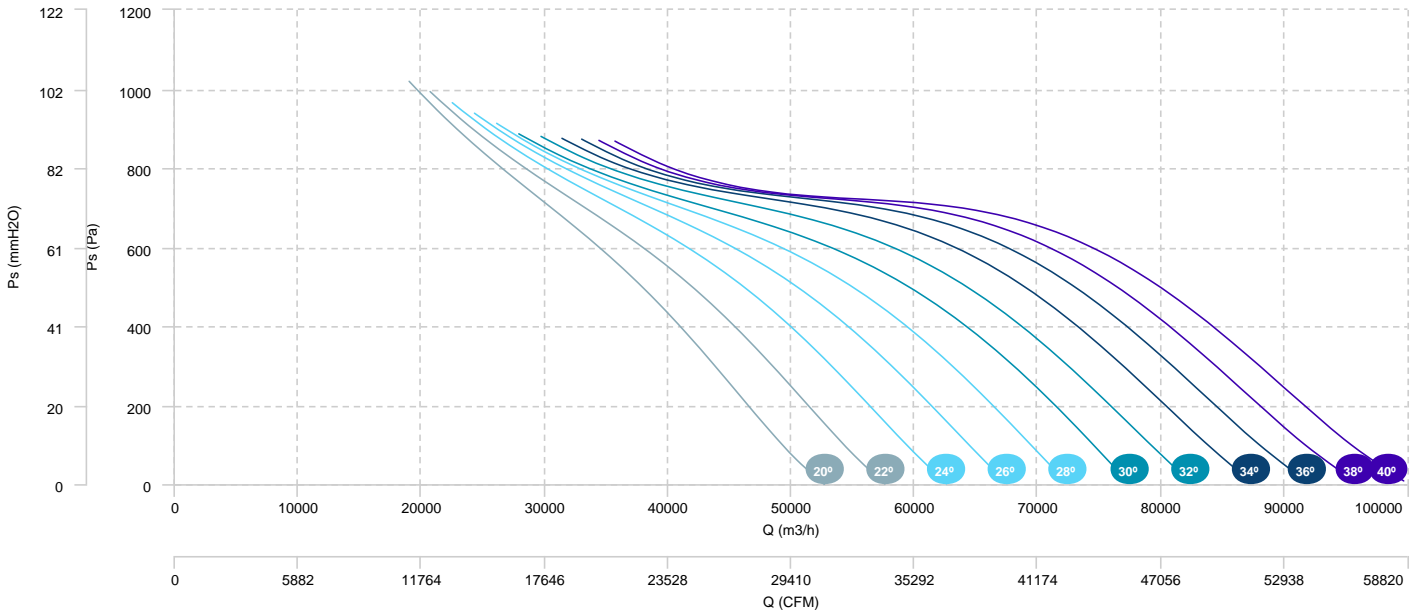

AIR FLOW - ABSORBED POWER

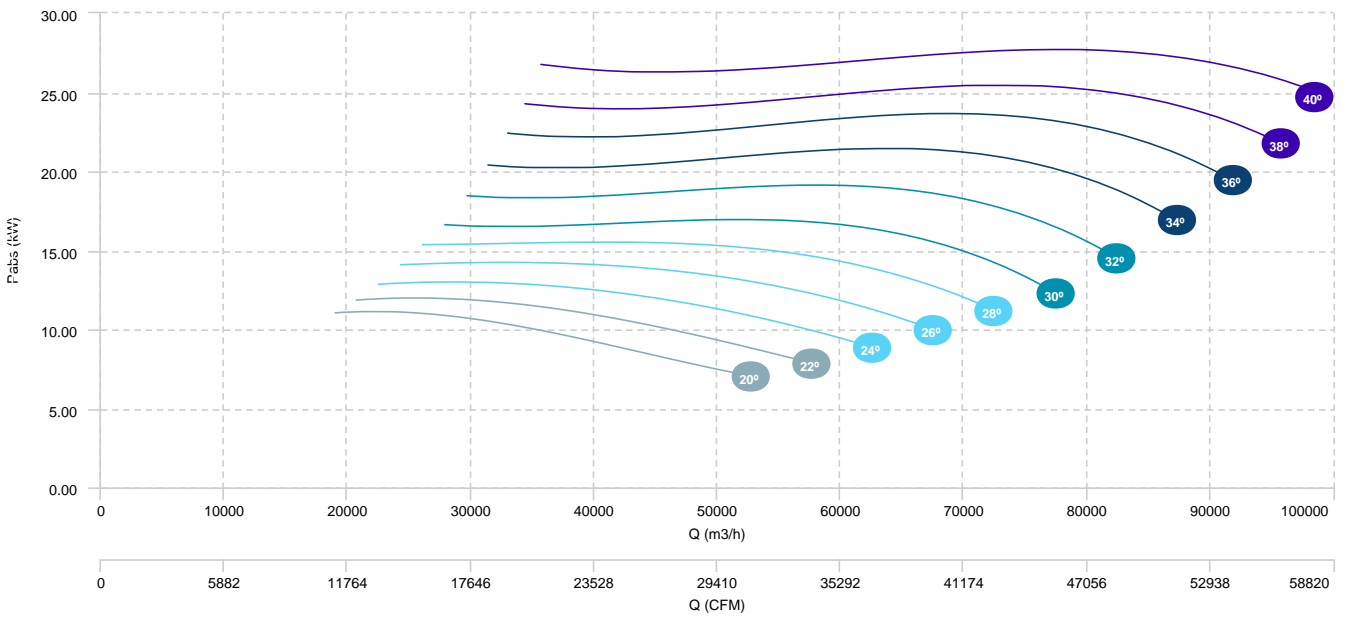

HMF 112 T4 5,5kW (A3:4) F400	HMF 112 T4 7,5kW (A3:4) F400	HMF 112 T4 11kW (A3:4) F400
HMF 112 T4 15kW (A3:4) F400	HMF 112 T4 18,5kW (A3:4) F400	

AIR FLOW - PRESSURE

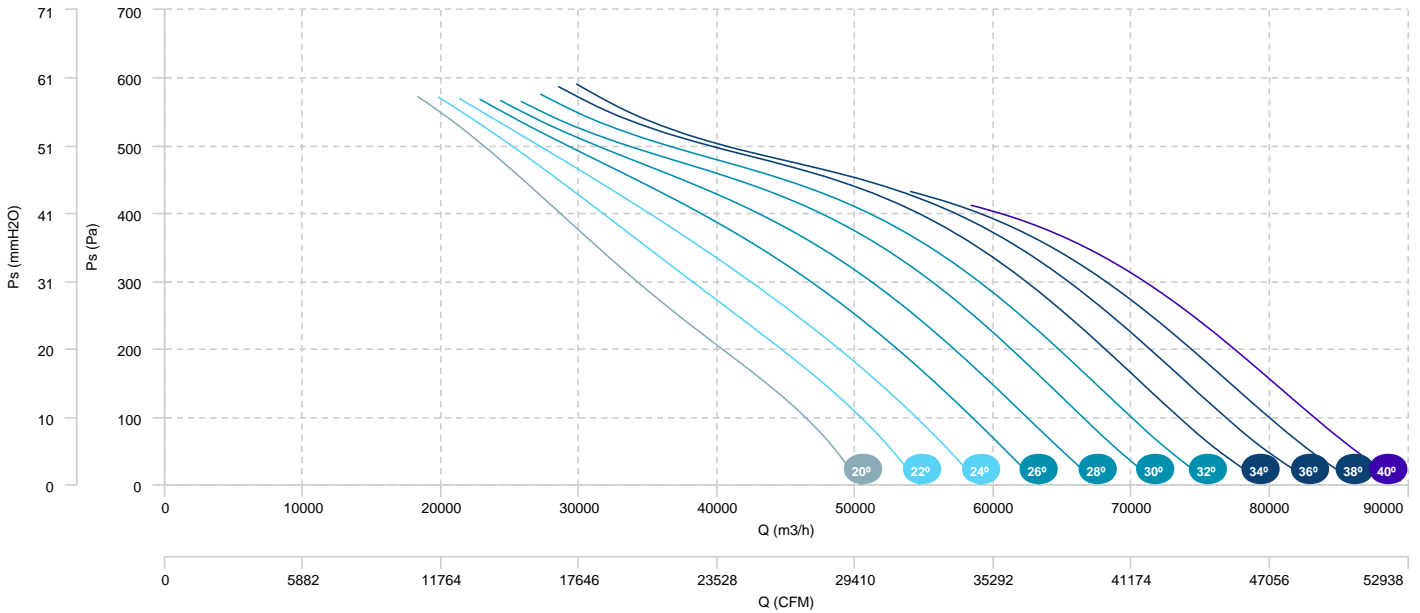

AIR FLOW - ABSORBED POWER

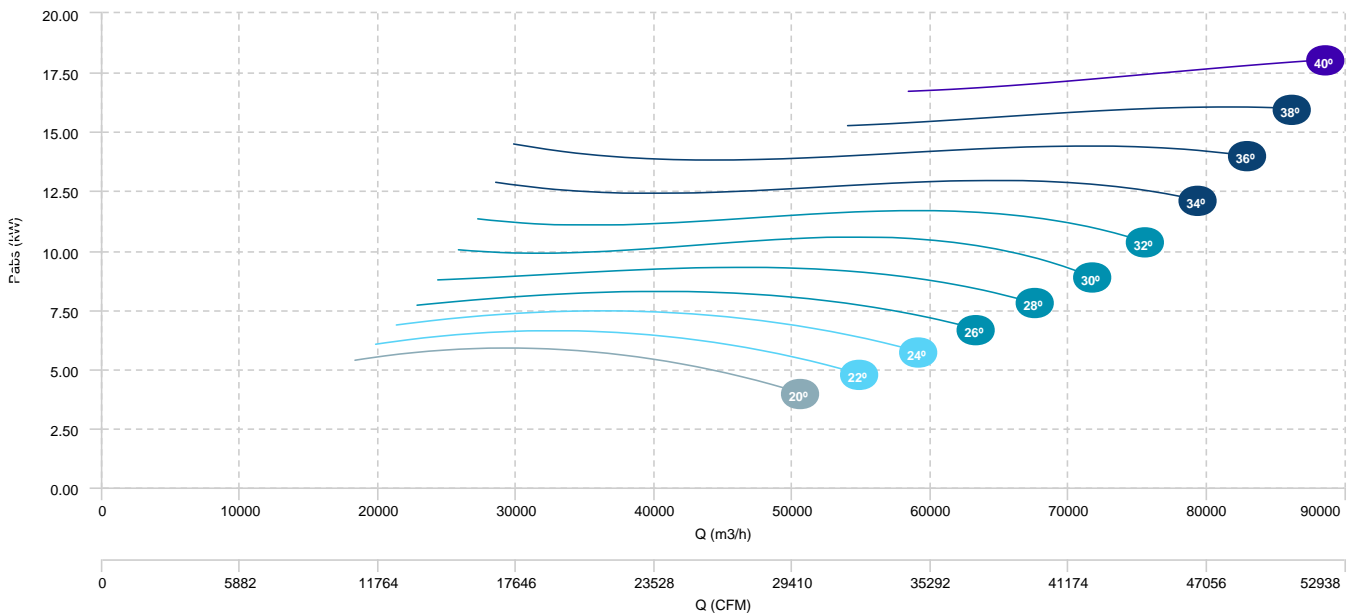

- HMF 112 T6 3kW (A3:8) F400
- HMF 112 T6 4kW (A3:8) F400
- HMF 112 T6 5,5kW (A3:8) F400
- HMF 112 T6 7,5kW (A3:8) F400

AIR FLOW - PRESSURE

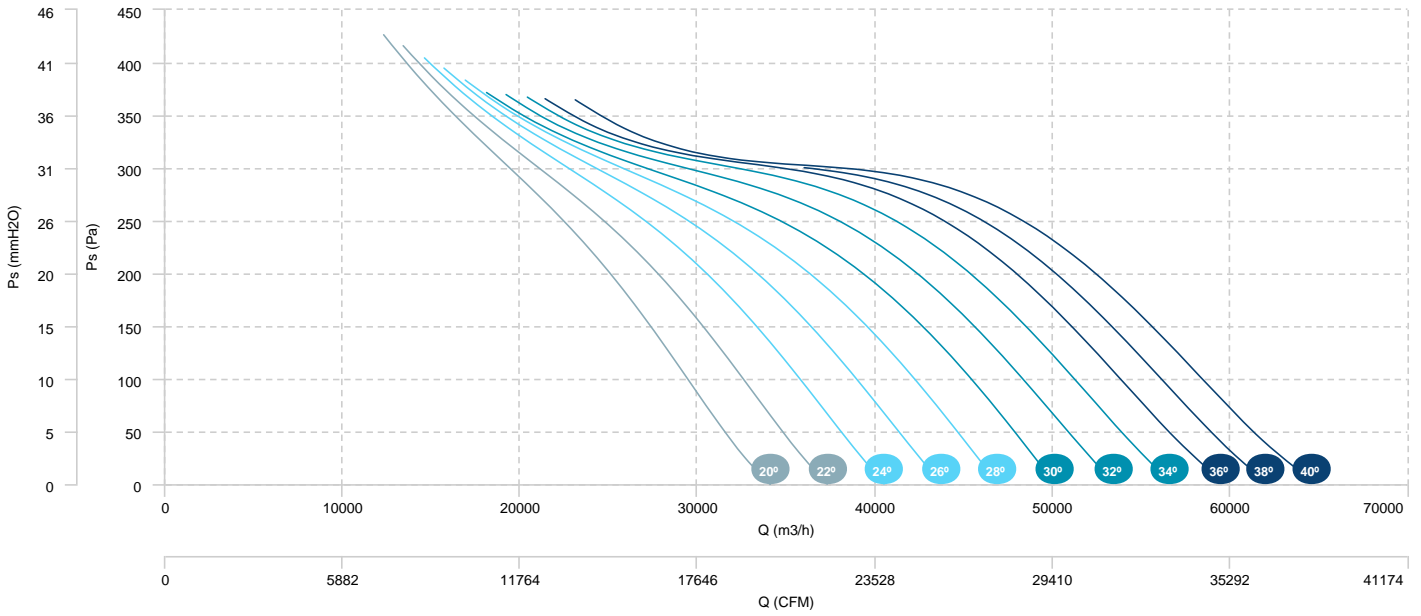

AIR FLOW - ABSORBED POWER

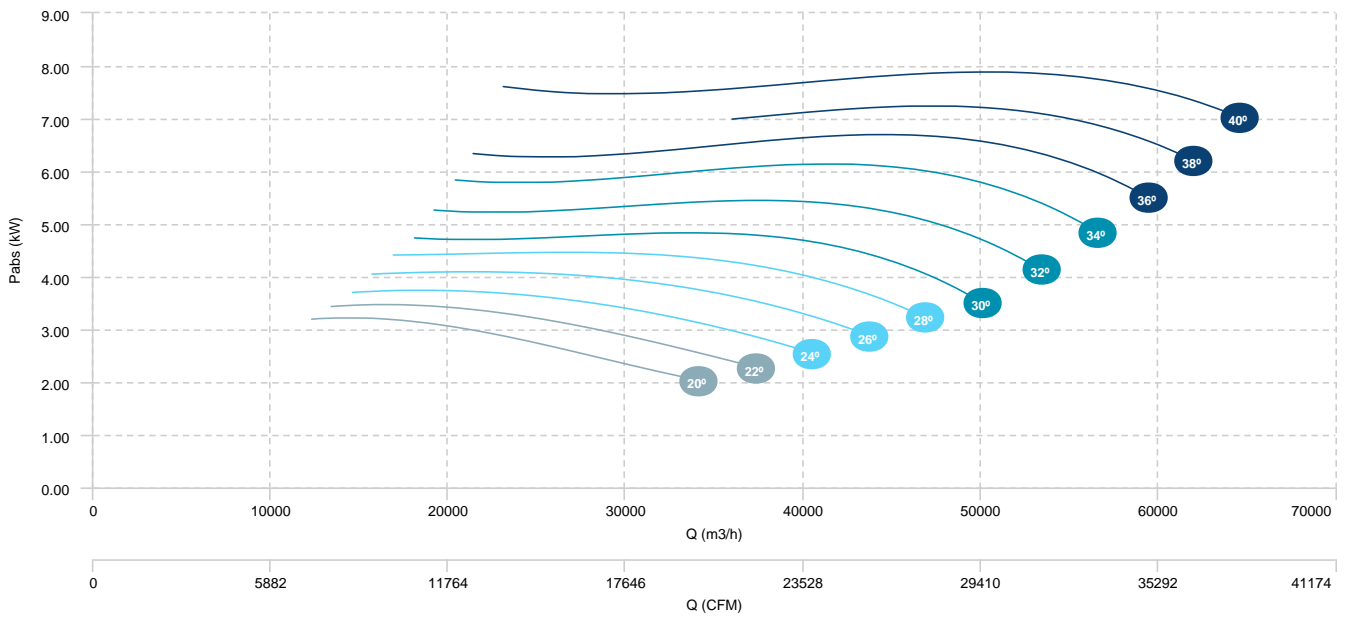

HMF 112 T6 2,2kW (A3:4) F400	HMF 112 T6 3kW (A3:4) F400	HMF 112 T6 4kW (A3:4) F400
HMF 112 T6 5,5kW (A3:4) F400		

AIR FLOW - PRESSURE

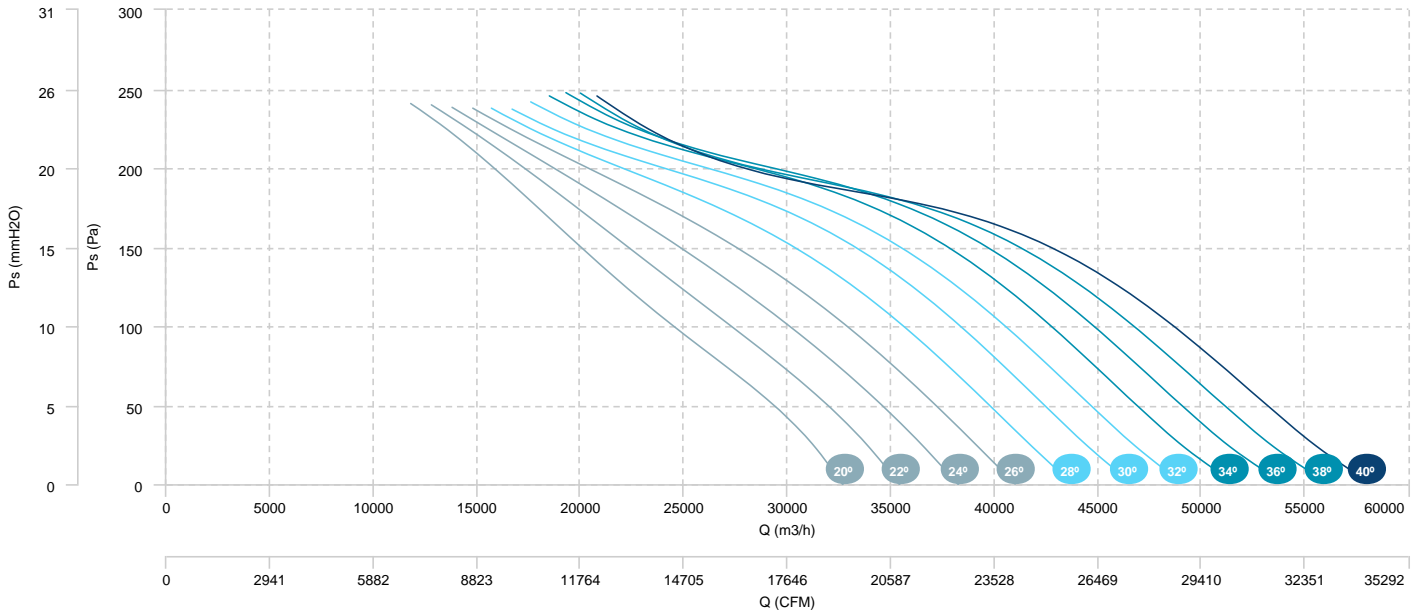

AIR FLOW - ABSORBED POWER

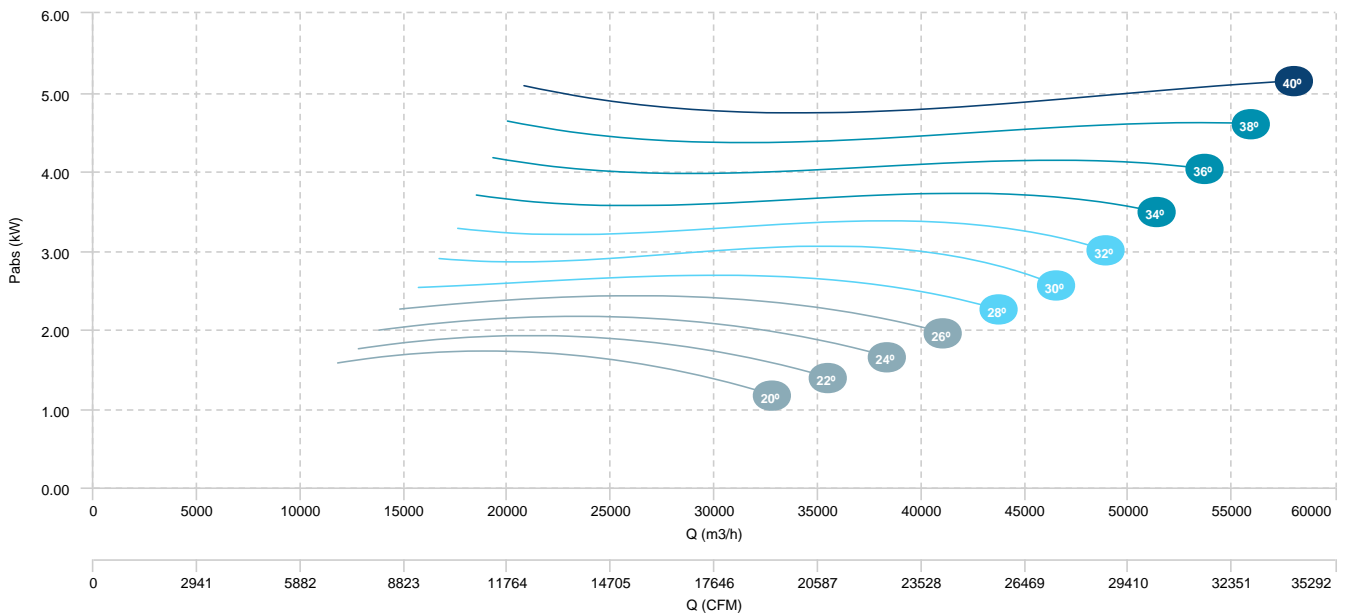

HMF 112 T4/T6 6/2,2kW (A3:4) F400	HMF 112 T4/T6 10/3,3kW (A3:4) F400	HMF 112 T4/T6 14/4,5kW (A3:4) F400
HMF 112 T4/T6 16/6,5kW (A3:4) F400	HMF 112 T4/T6 20/8,5kW (A3:4) F400	

AIR FLOW - PRESSURE (4 poles)

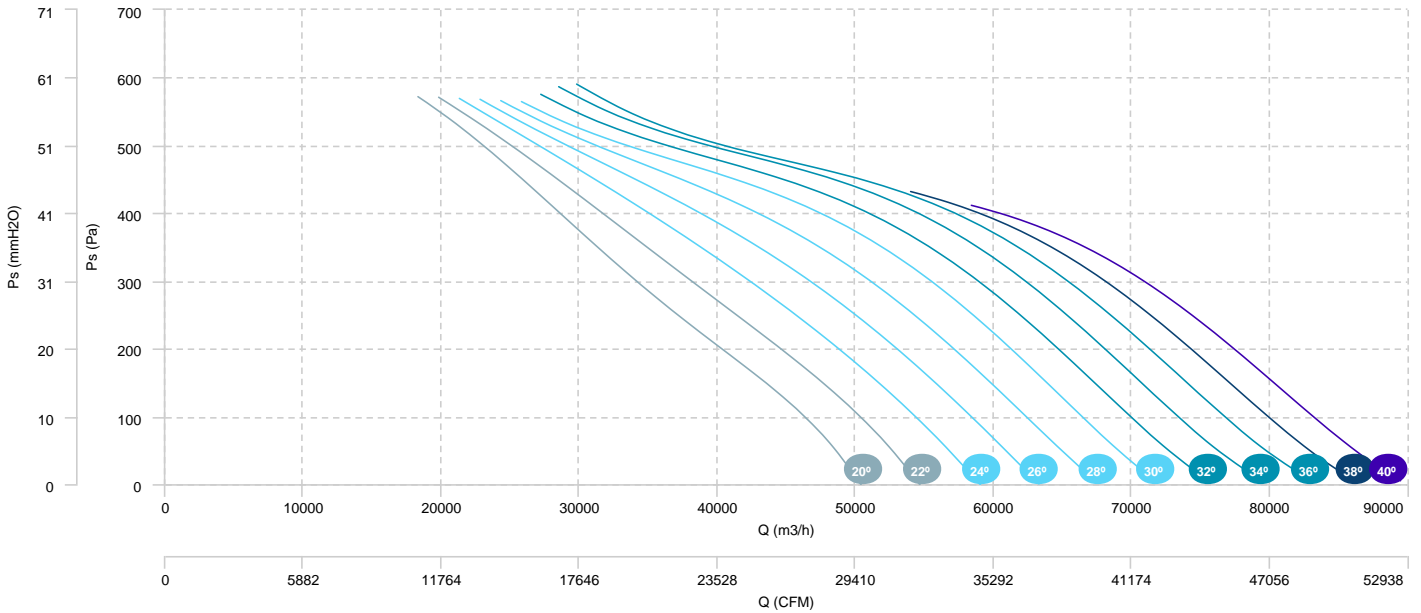

AIR FLOW - ABSORBED POWER (4 poles)

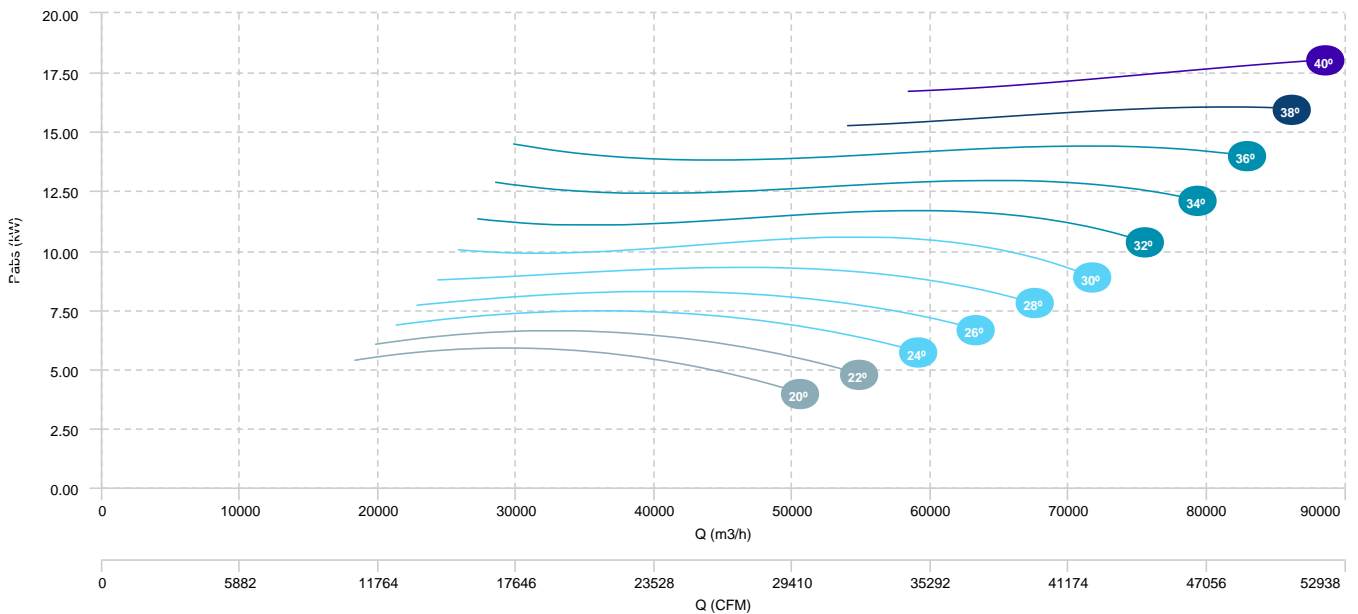

HMF 112 T4/T6 6/2,2kW (A3:4) F400	HMF 112 T4/T6 10/3,3kW (A3:4) F400	HMF 112 T4/T6 14/4,5kW (A3:4) F400
HMF 112 T4/T6 16/6,5kW (A3:4) F400	HMF 112 T4/T6 20/8,5kW (A3:4) F400	

AIR FLOW - PRESSURE (6 poles)

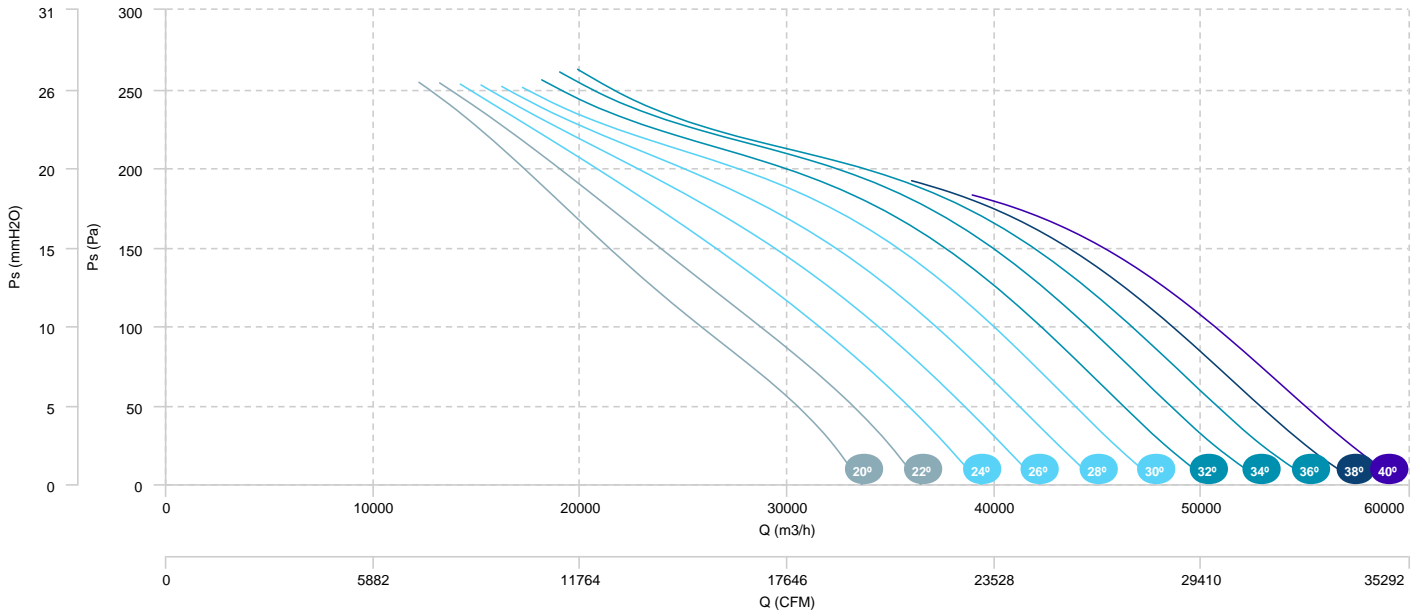

HMF 112 T4/T6 14/4,5kW (A3:8) F400	HMF 112 T4/T6 16/6,5kW (A3:8) F400	HMF 112 T4/T6 20/8,5kW (A3:8) F400
HMF 112 T4/T6 26/9kW (A3:8) F400	HMF 112 T4/T6 34/12kW (A3:8) F400	

AIR FLOW - PRESSURE (4 poles)

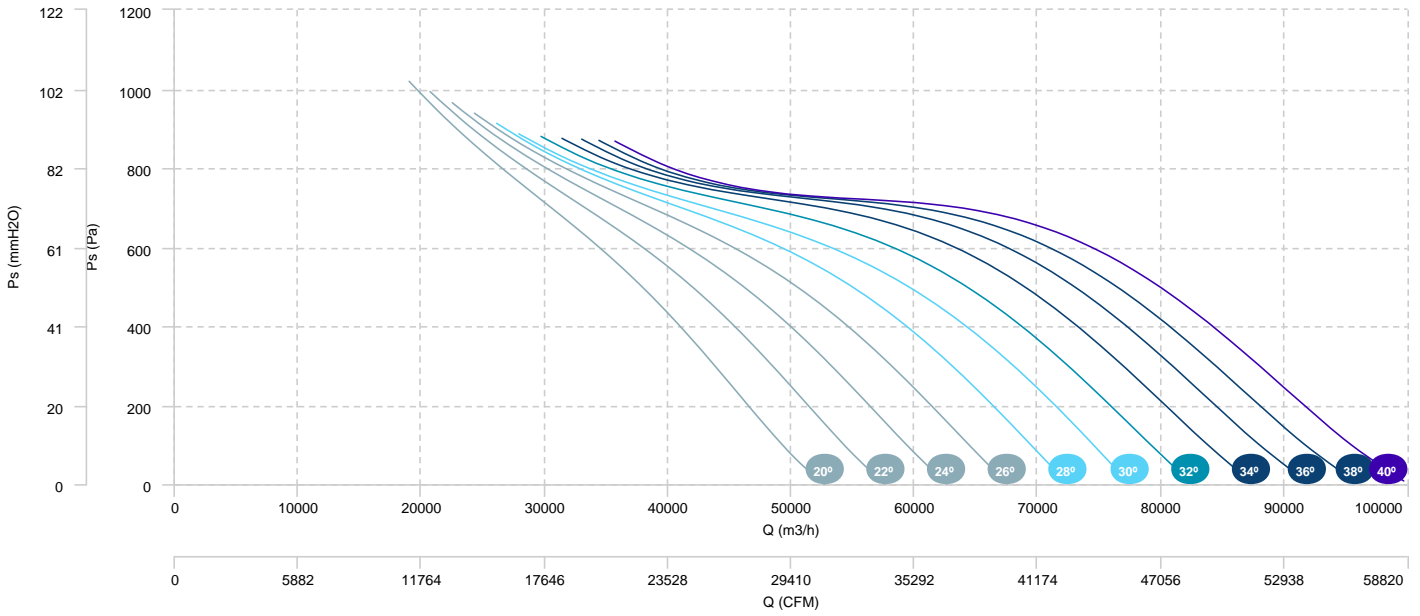

AIR FLOW - ABSORBED POWER (4 poles)

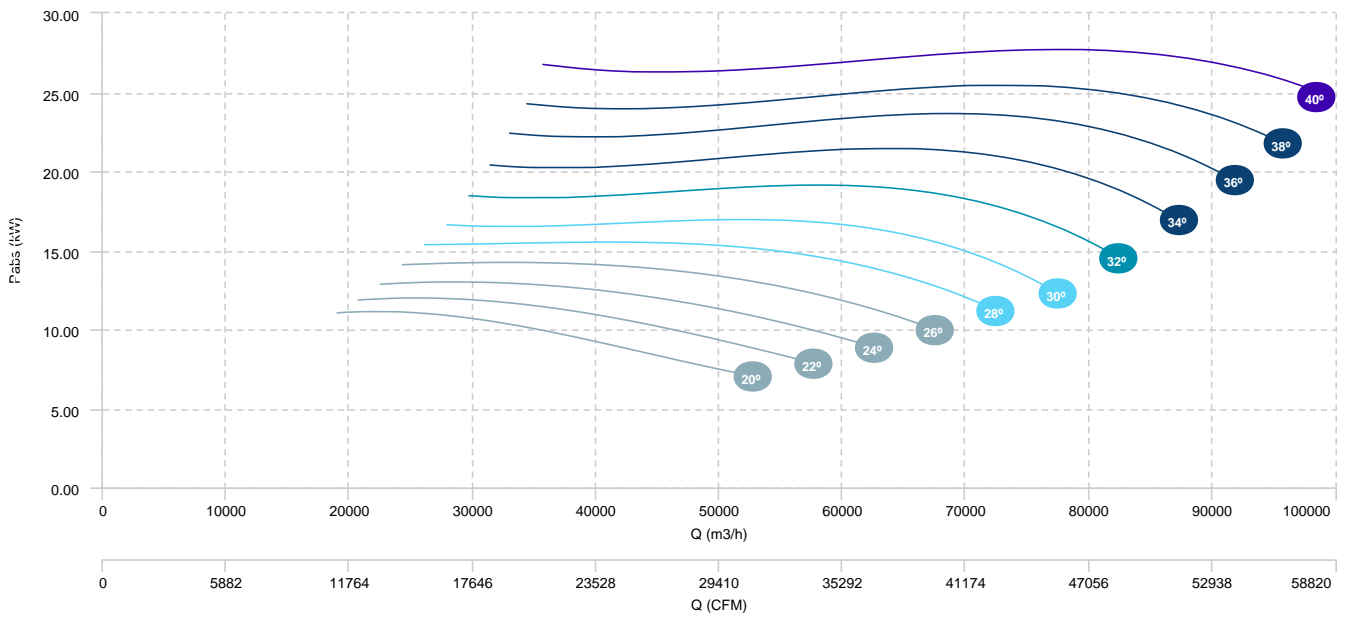

HMF 112 T4/T6 14/4,5kW (A3:8) F400	HMF 112 T4/T6 16/6,5kW (A3:8) F400	HMF 112 T4/T6 20/8,5kW (A3:8) F400
HMF 112 T4/T6 26/9kW (A3:8) F400	HMF 112 T4/T6 34/12kW (A3:8) F400	

AIR FLOW - PRESSURE (6 poles)

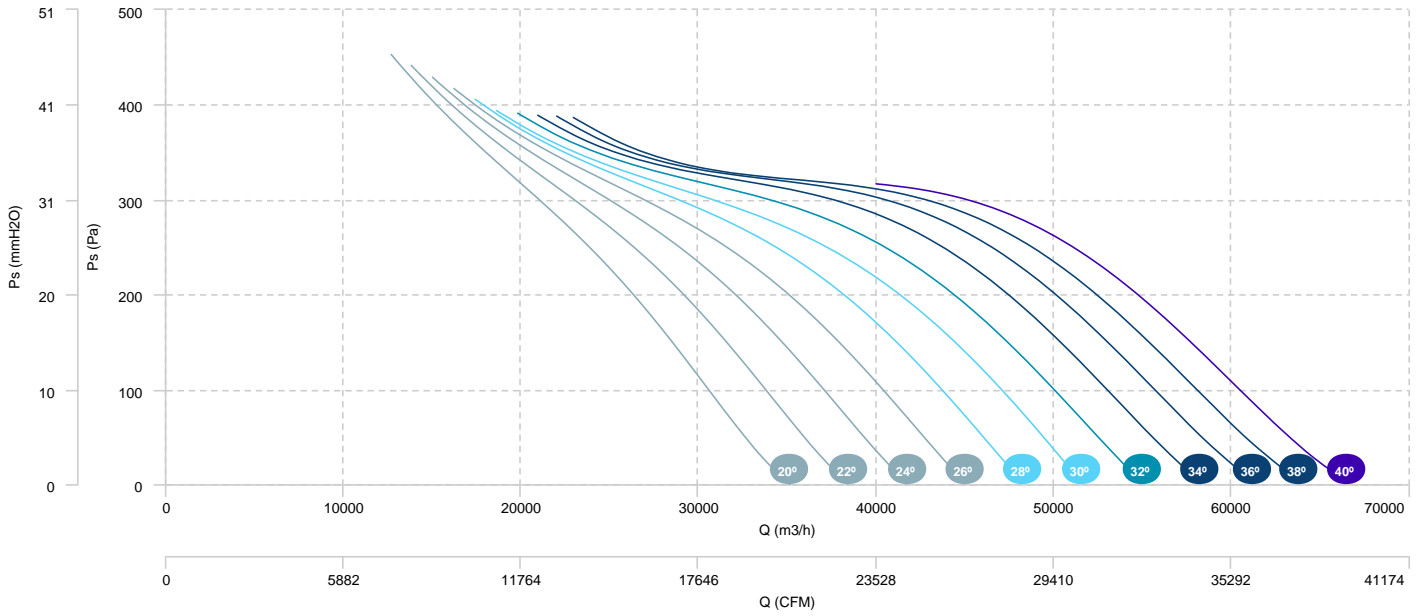

HMF 112 T4/T8 11/3kW (A3:8) F400	HMF 112 T4/T8 14/3,5kW (A3:8) F400	HMF 112 T4/T8 17/4,3kW (A3:8) F400
HMF 112 T4/T8 20/5kW (A3:8) F400	HMF 112 T4/T8 28/6,5kW (A3:8) F400	

AIR FLOW - PRESSURE (4 poles)

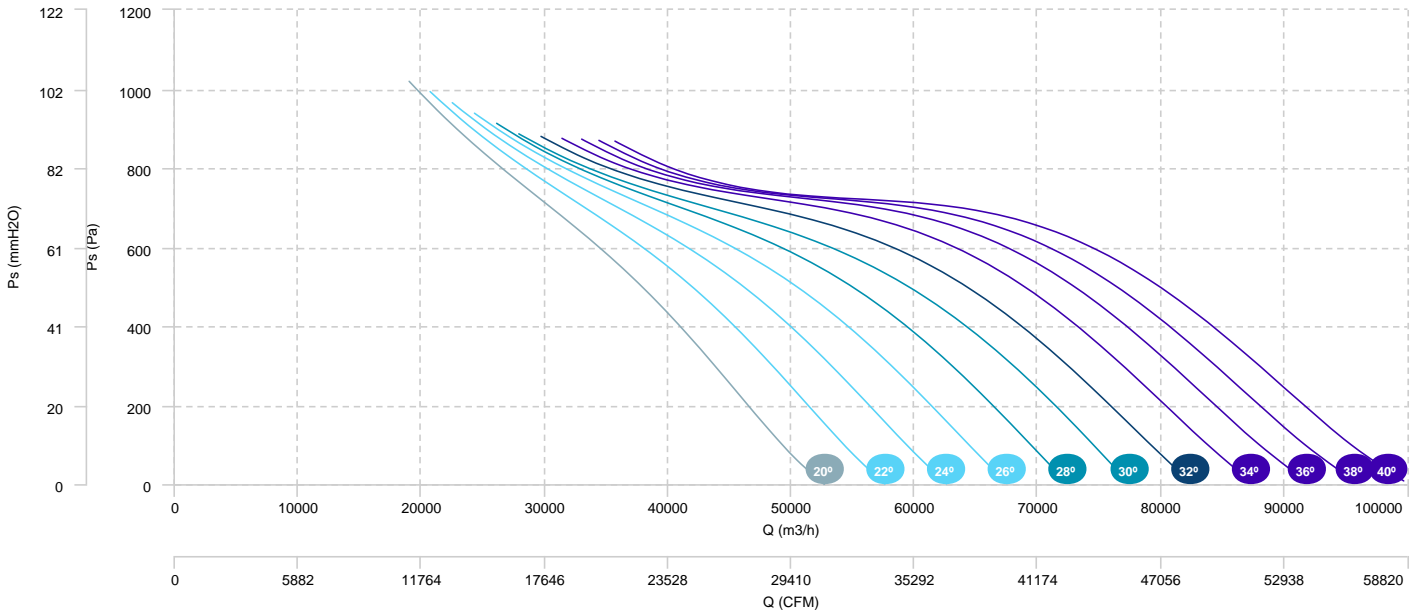

AIR FLOW - ABSORBED POWER (4 poles)

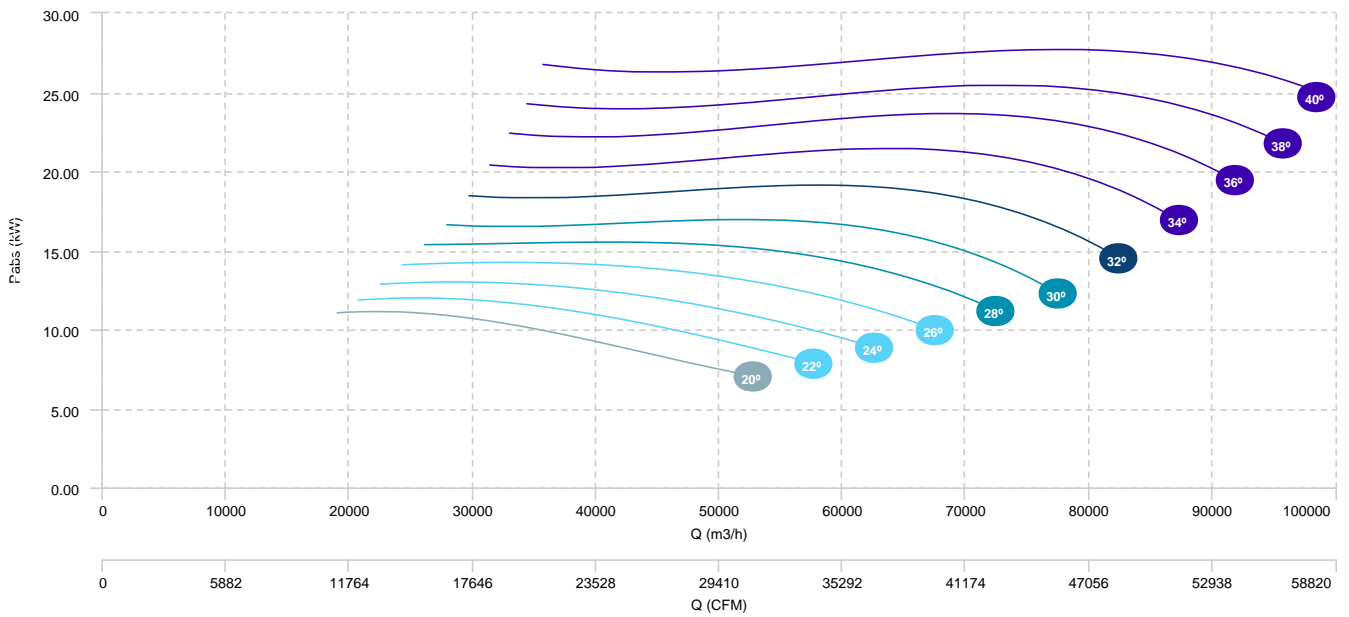

HMF 112 T4/T8 11/3kW (A3:8) F400	HMF 112 T4/T8 14/3,5kW (A3:8) F400	HMF 112 T4/T8 17/4,3kW (A3:8) F400
HMF 112 T4/T8 20/5kW (A3:8) F400	HMF 112 T4/T8 28/6,5kW (A3:8) F400	

AIR FLOW - PRESSURE (8 poles)

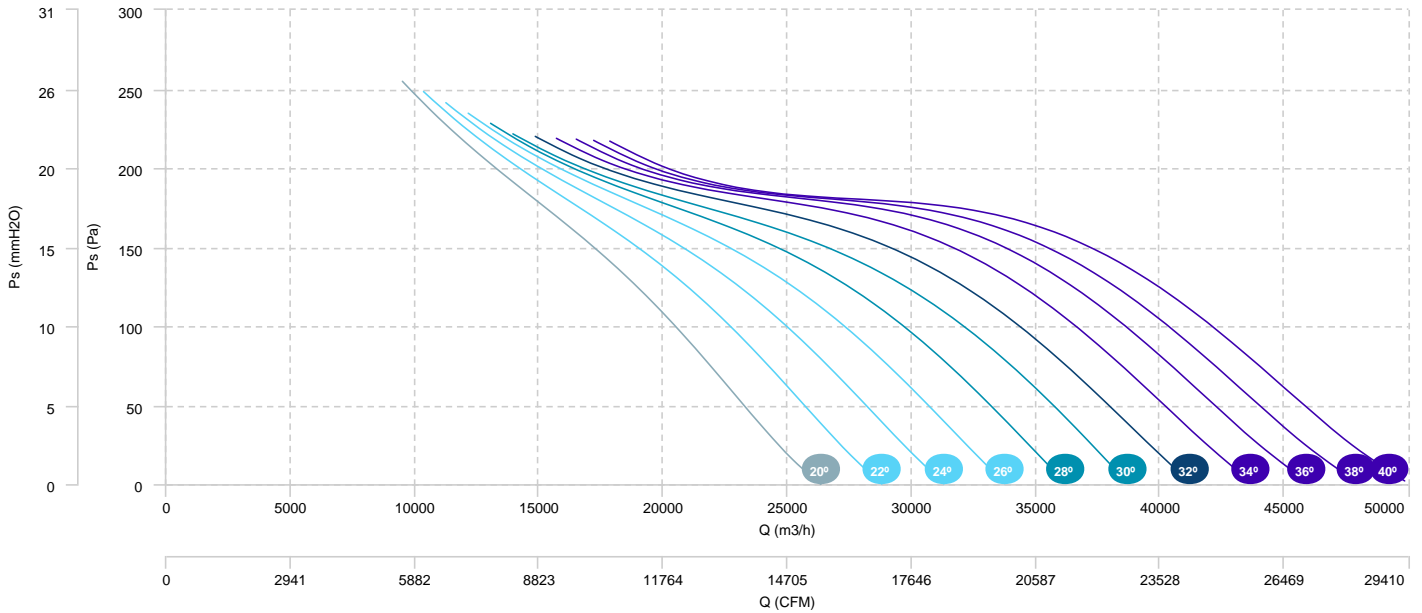

HMF 112 T4/T8 5,5/1,1kW (A3:4) F400	HMF 112 T4/T8 7,5/1,5kW (A3:4) F400	HMF 112 T4/T8 11/3kW (A3:4) F400
HMF 112 T4/T8 14/3,5kW (A3:4) F400	HMF 112 T4/T8 17/4,3kW (A3:4) F400	

AIR FLOW - PRESSURE (4 poles)

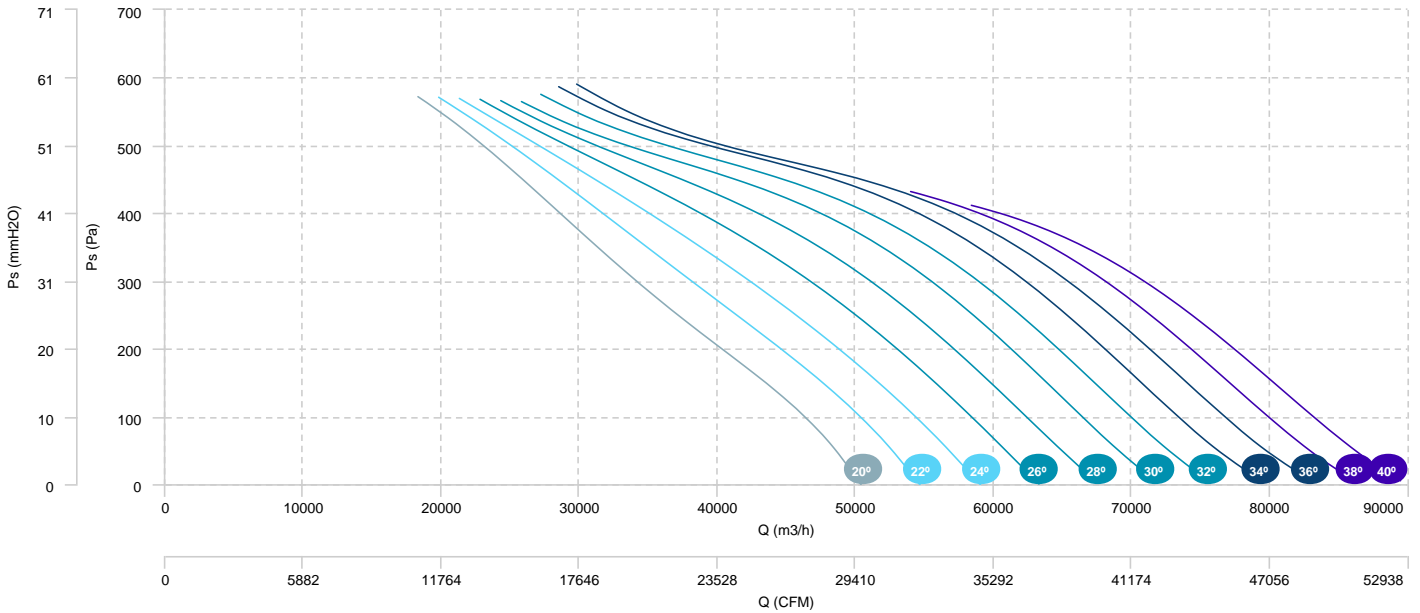

AIR FLOW - ABSORBED POWER (4 poles)

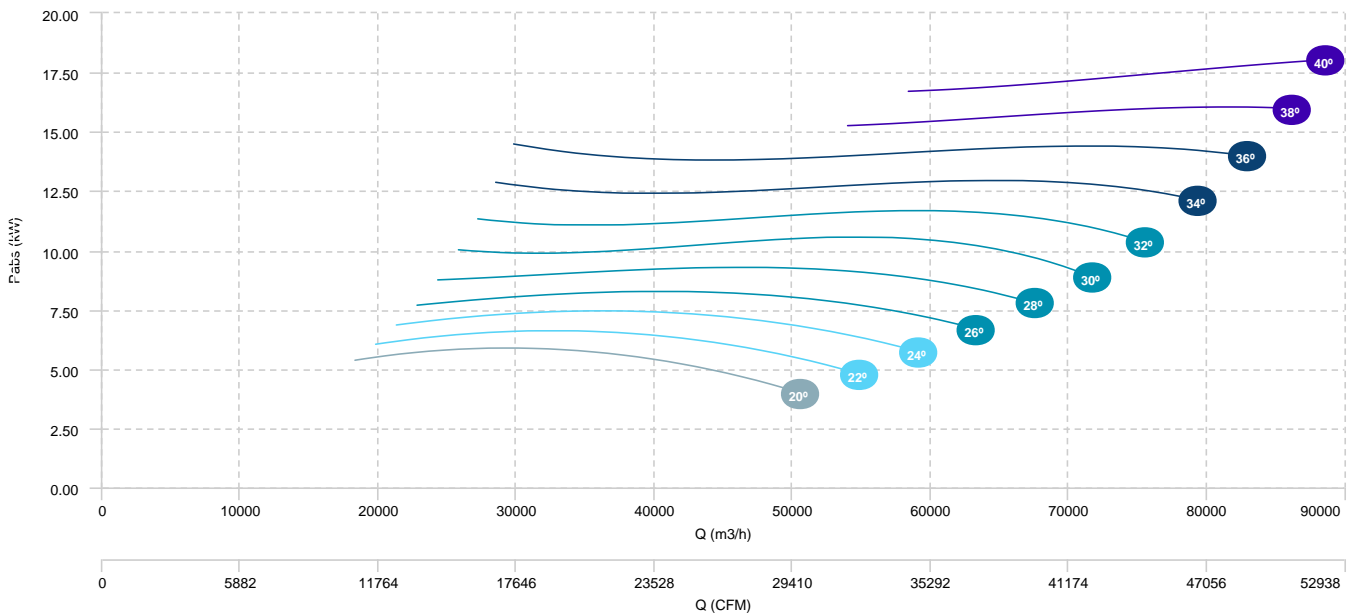

HMF 112 T4/T8 5,5/1,1kW (A3:4) F400	HMF 112 T4/T8 7,5/1,5kW (A3:4) F400	HMF 112 T4/T8 11/3kW (A3:4) F400
HMF 112 T4/T8 14/3,5kW (A3:4) F400	HMF 112 T4/T8 17/4,3kW (A3:4) F400	

AIR FLOW - PRESSURE (8 poles)

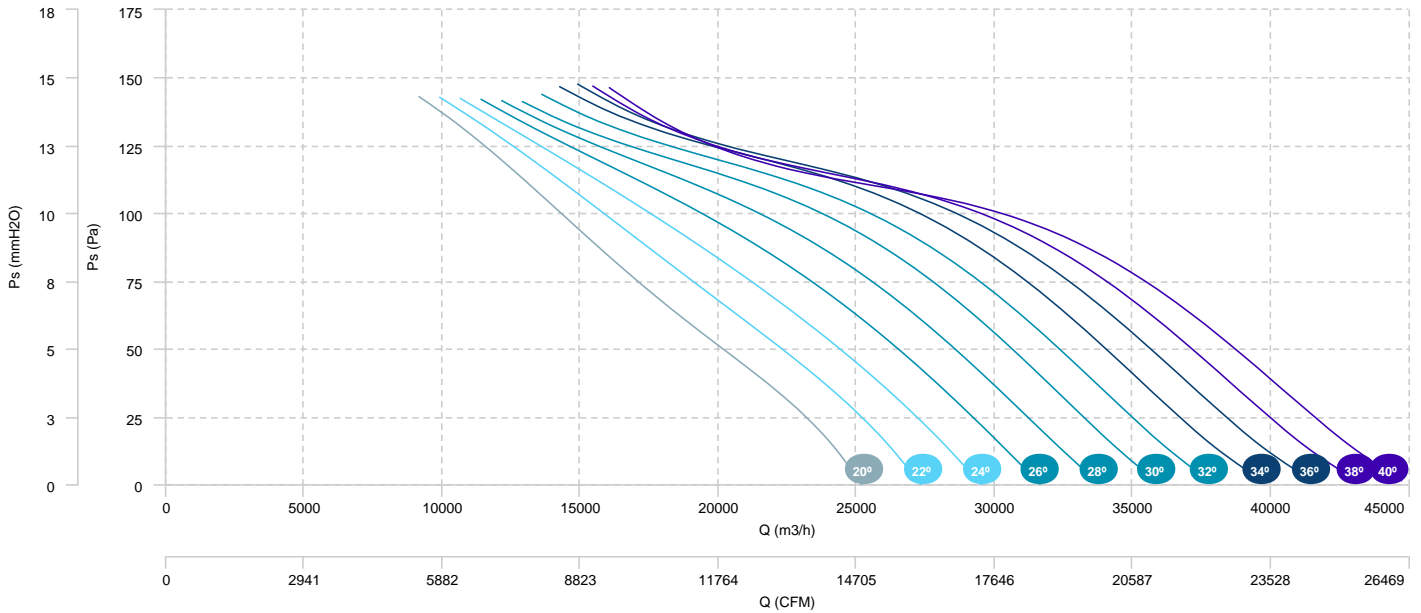

HMF 125 T4 18,5kW (A3:8) F400	HMF 125 T4 22kW (A3:8) F400	HMF 125 T4 30kW (A3:8) F400
HMF 125 T4 37kW (A3:8) F400	HMF 125 T4 45kW (A3:8) F400	

AIR FLOW - PRESSURE

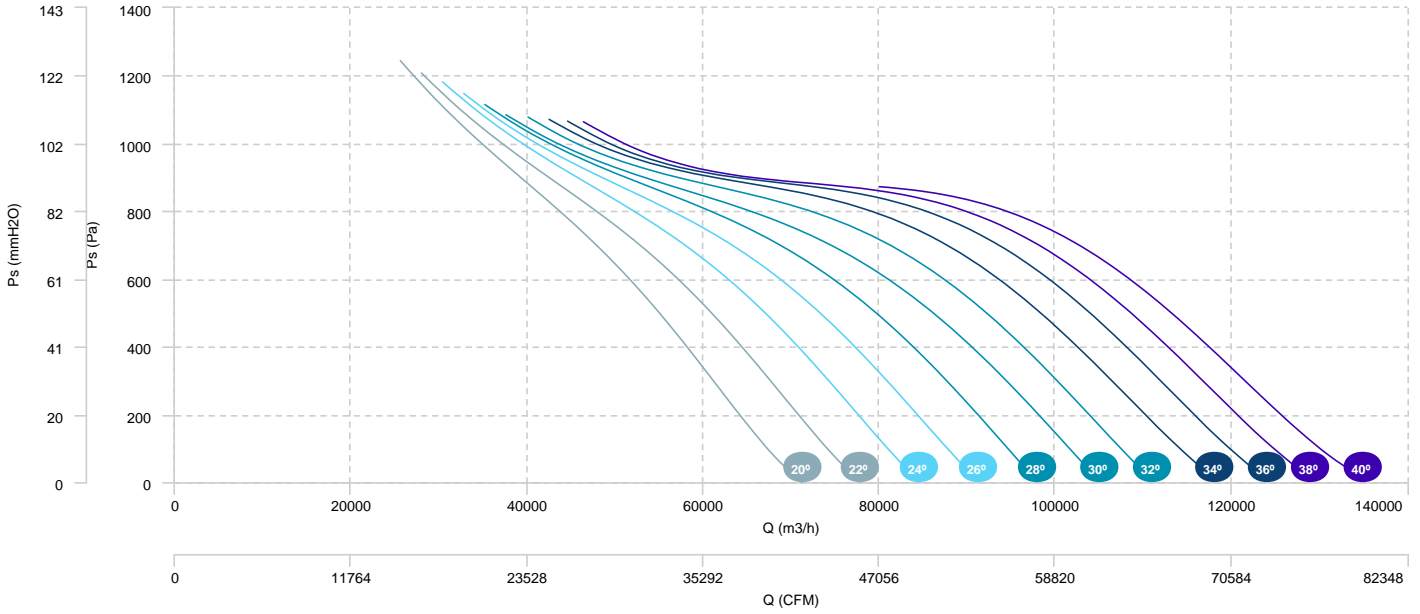

AIR FLOW - ABSORBED POWER

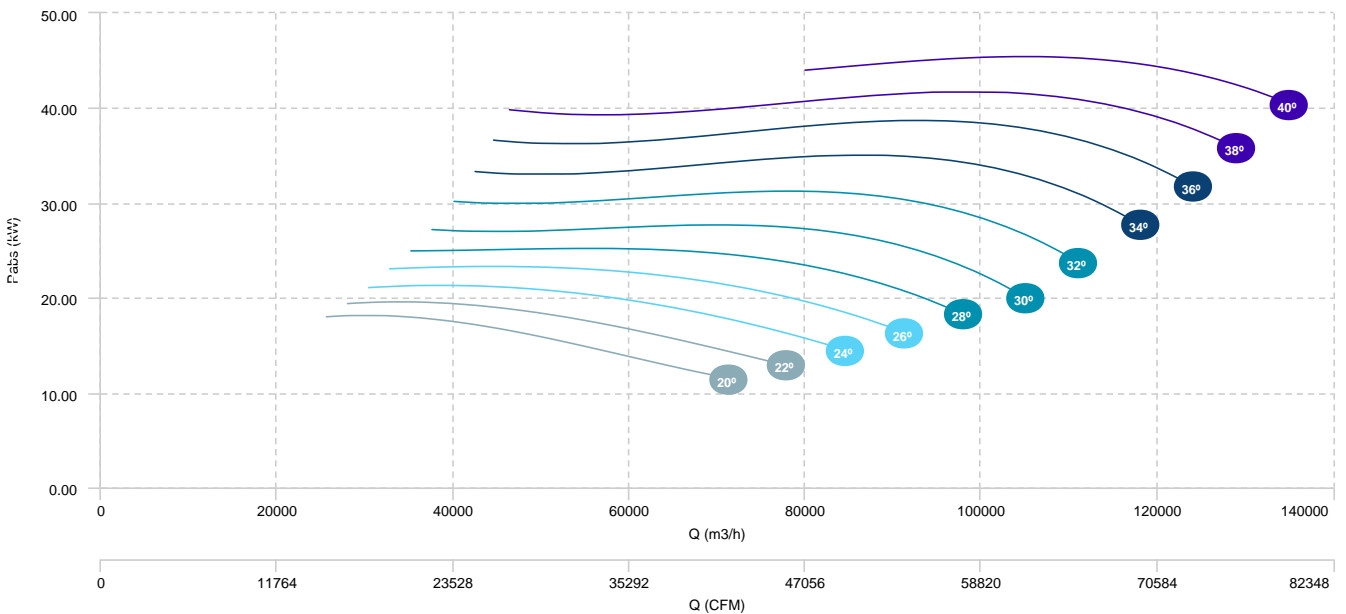

HMF 125 T4 11kW (A3:4) F400	HMF 125 T4 15kW (A3:4) F400	HMF 125 T4 18,5kW (A3:4) F400
HMF 125 T4 22kW (A3:4) F400	HMF 125 T4 30kW (A3:4) F400	

AIR FLOW - PRESSURE

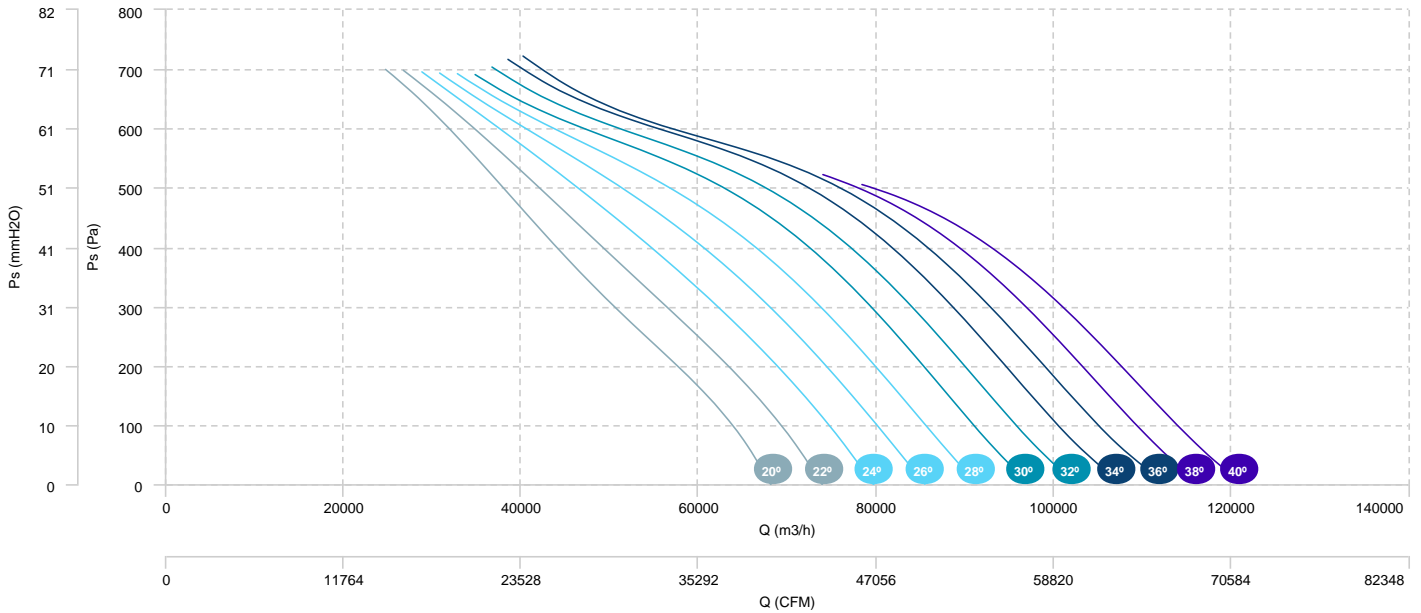

AIR FLOW - ABSORBED POWER

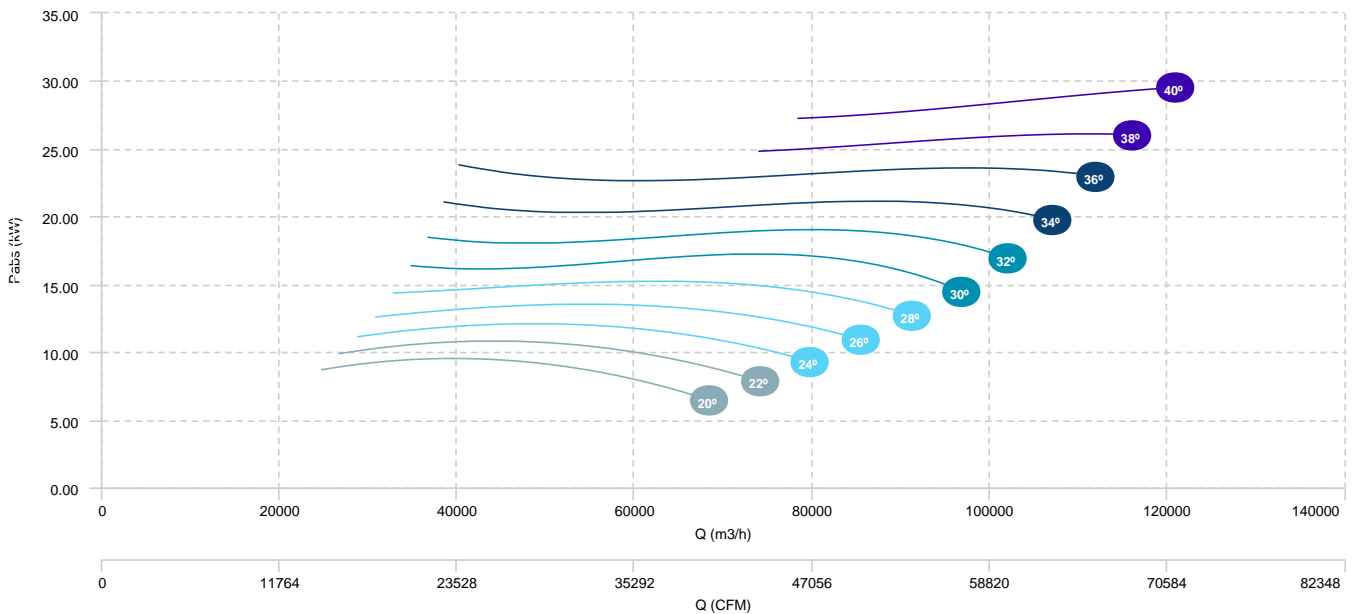

HMF 125 T6 5,5kW (A3:8) F400	HMF 125 T6 7,5kW (A3:8) F400	HMF 125 T6 11kW (A3:8) F400
HMF 125 T6 15kW (A3:8) F400		

AIR FLOW - PRESSURE

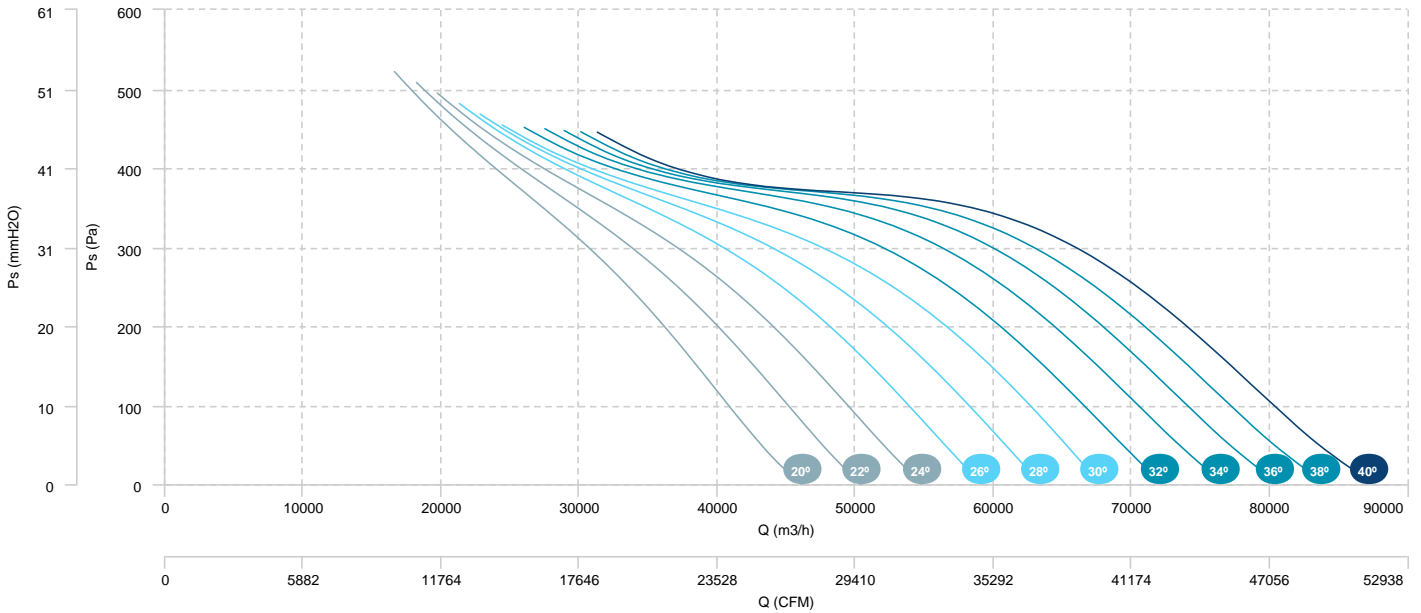

AIR FLOW - ABSORBED POWER

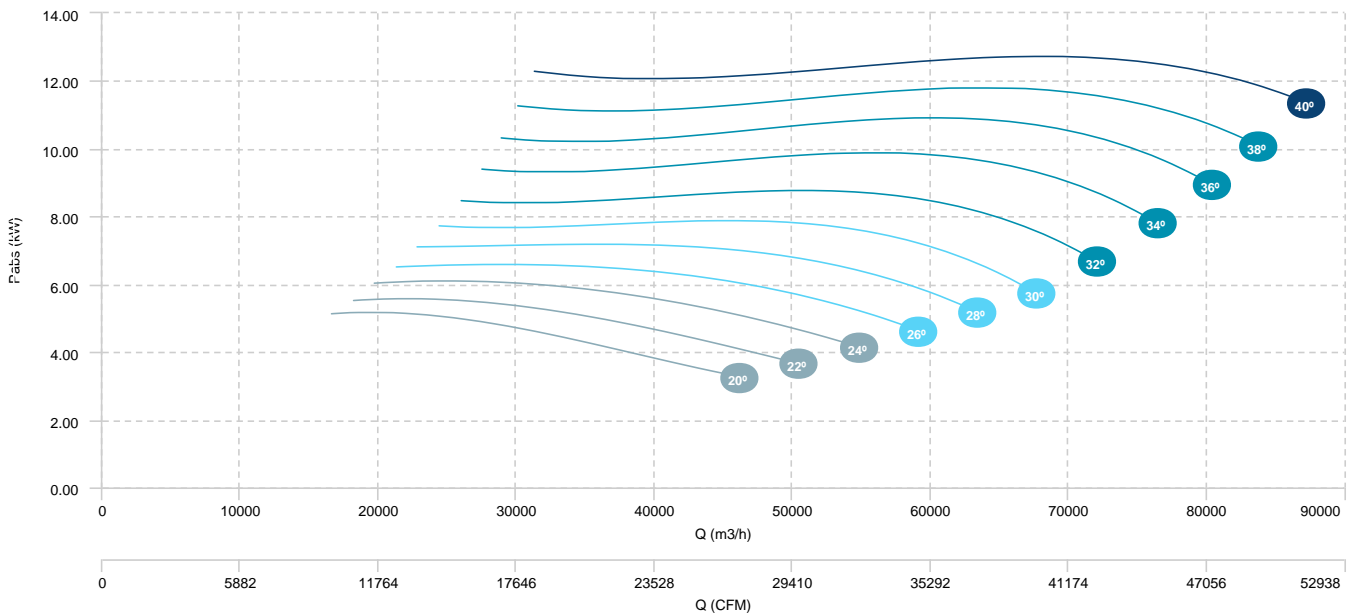

HMF 125 T6 3kW (A3:4) F400
 HMF 125 T6 7,5kW (A3:4) F400

HMF 125 T6 4kW (A3:4) F400

HMF 125 T6 5,5kW (A3:4) F400

AIR FLOW - PRESSURE

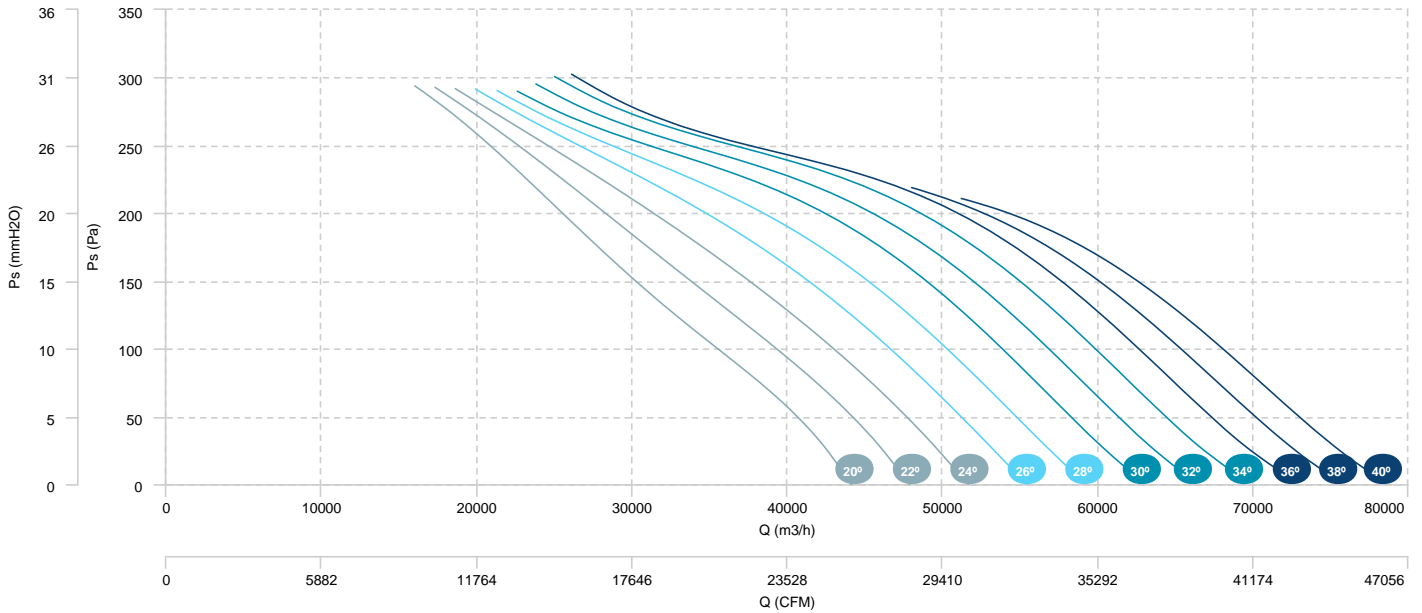

AIR FLOW - ABSORBED POWER

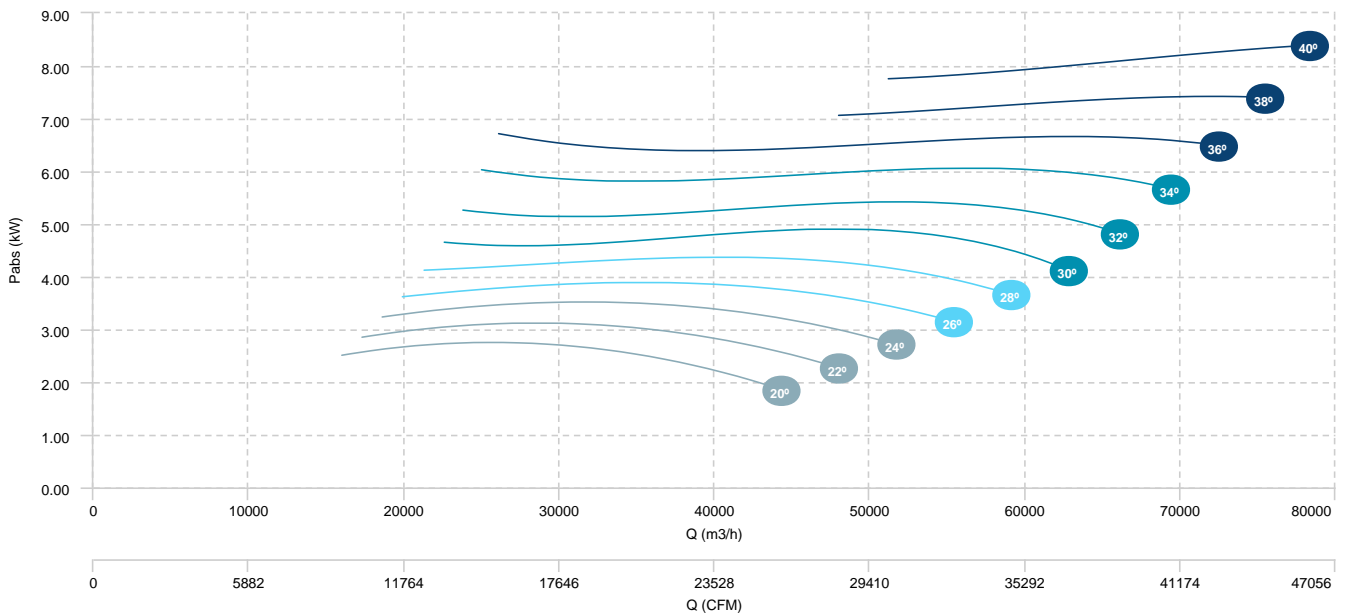

HMF 125 T4/T6 20/8,5kW (A3:8) F400

HMF 125 T4/T6 26/9kW (A3:8) F400

HMF 125 T4/T6 34/12kW (A3:8) F400

HMF 125 T4/T6 40/14kW (A3:8) F400

AIR FLOW - PRESSURE (4 poles)

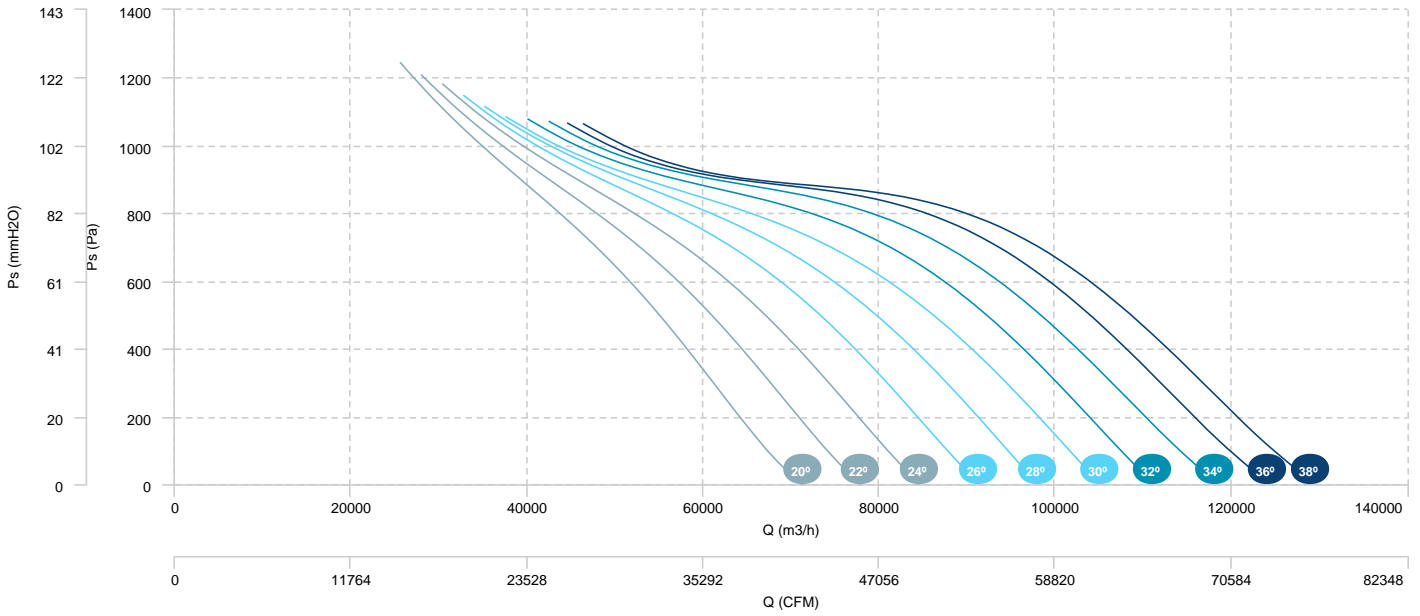

AIR FLOW - ABSORBED POWER (4 poles)

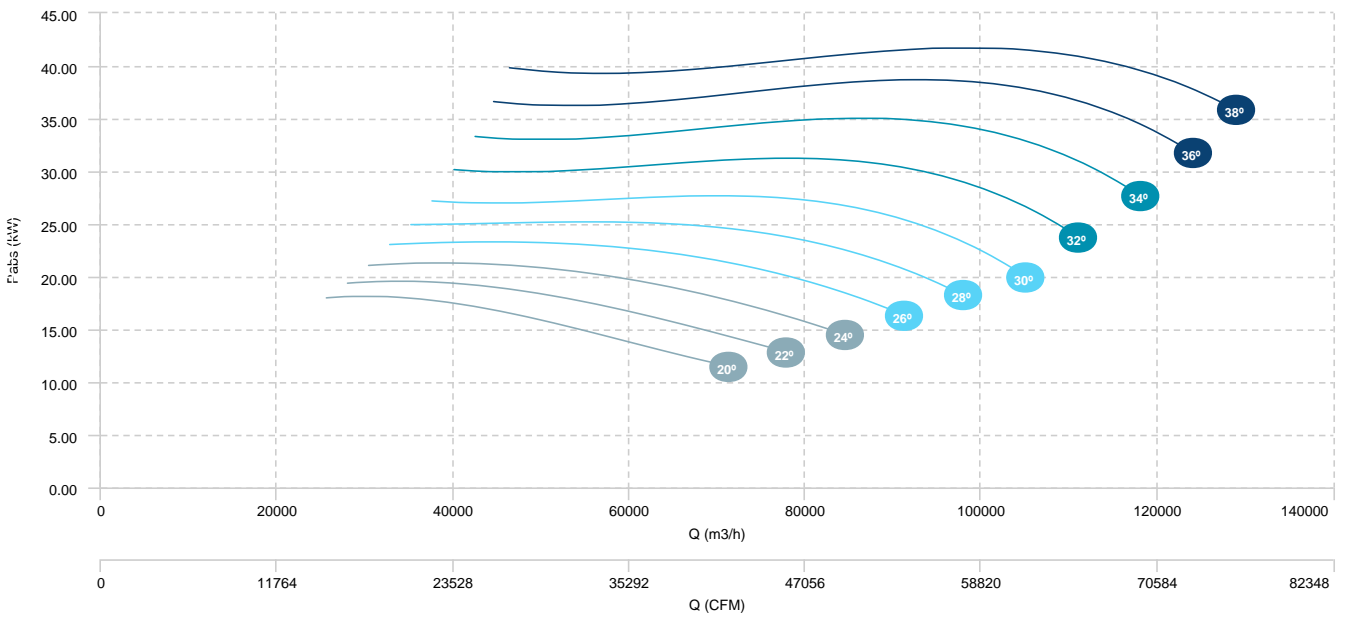

HMF 125 T4/T6 20/8,5kW (A3:8) F400	HMF 125 T4/T6 26/9kW (A3:8) F400	HMF 125 T4/T6 34/12kW (A3:8) F400
HMF 125 T4/T6 40/14kW (A3:8) F400		

AIR FLOW - PRESSURE (6 poles)

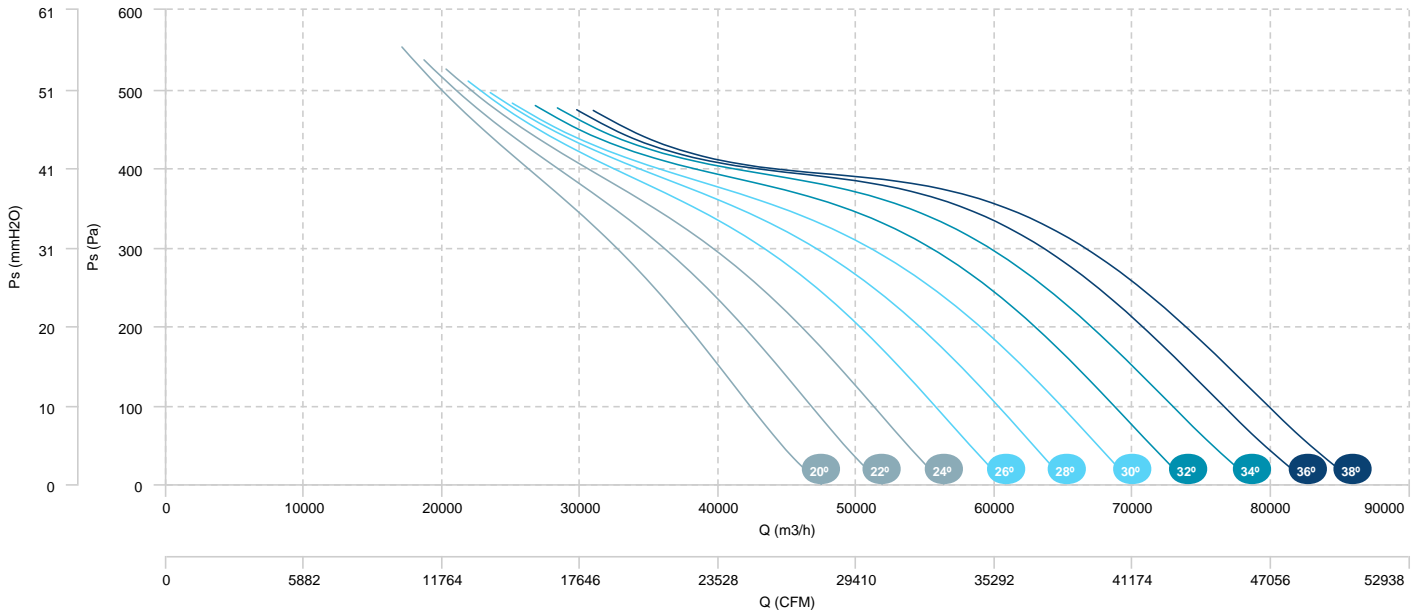

HMF 125 T4/T6 10/3,3kW (A3:4) F400	HMF 125 T4/T6 14/4,5kW (A3:4) F400	HMF 125 T4/T6 16/6,5kW (A3:4) F400
HMF 125 T4/T6 20/8,5kW (A3:4) F400	HMF 125 T4/T6 26/9kW (A3:4) F400	HMF 125 T4/T6 34/12kW (A3:4) F400

AIR FLOW - PRESSURE (4 poles)

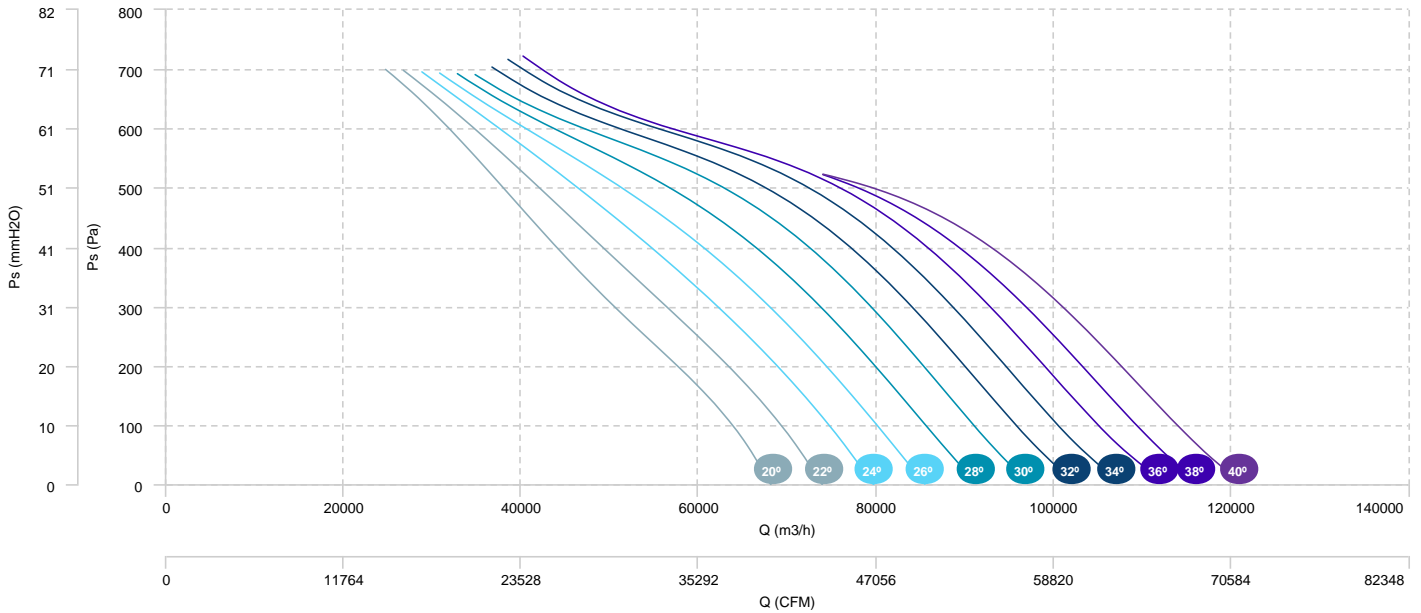

AIR FLOW - ABSORBED POWER (4 poles)

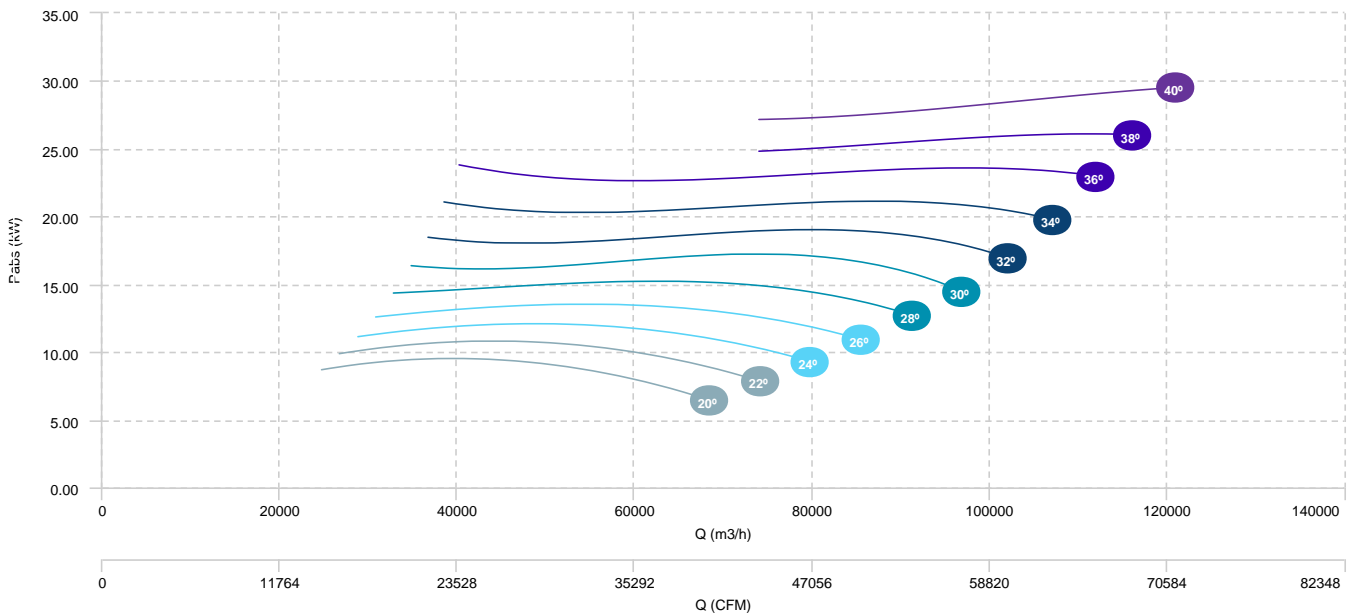

HMF 125 T4/T6 10/3,3kW (A3:4) F400	HMF 125 T4/T6 14/4,5kW (A3:4) F400	HMF 125 T4/T6 16/6,5kW (A3:4) F400
HMF 125 T4/T6 20/8,5kW (A3:4) F400	HMF 125 T4/T6 26/9kW (A3:4) F400	HMF 125 T4/T6 34/12kW (A3:4) F400

AIR FLOW - PRESSURE (6 poles)

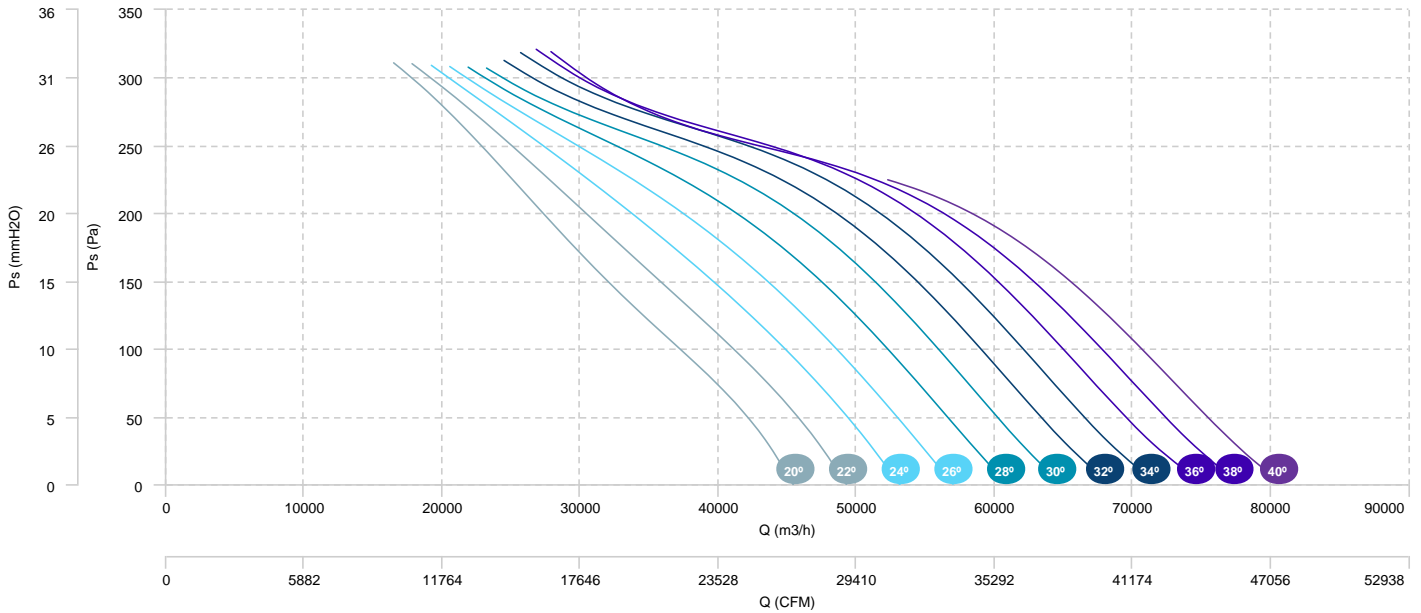

HMF 125 T4/T8 20/5kW (A3:8) F400
 HMF 125 T4/T8 44/11kW (A3:8) F400

HMF 125 T4/T8 28/6,5kW (A3:8) F400

HMF 125 T4/T8 37/9,2kW (A3:8) F400

AIR FLOW - PRESSURE (4 poles)

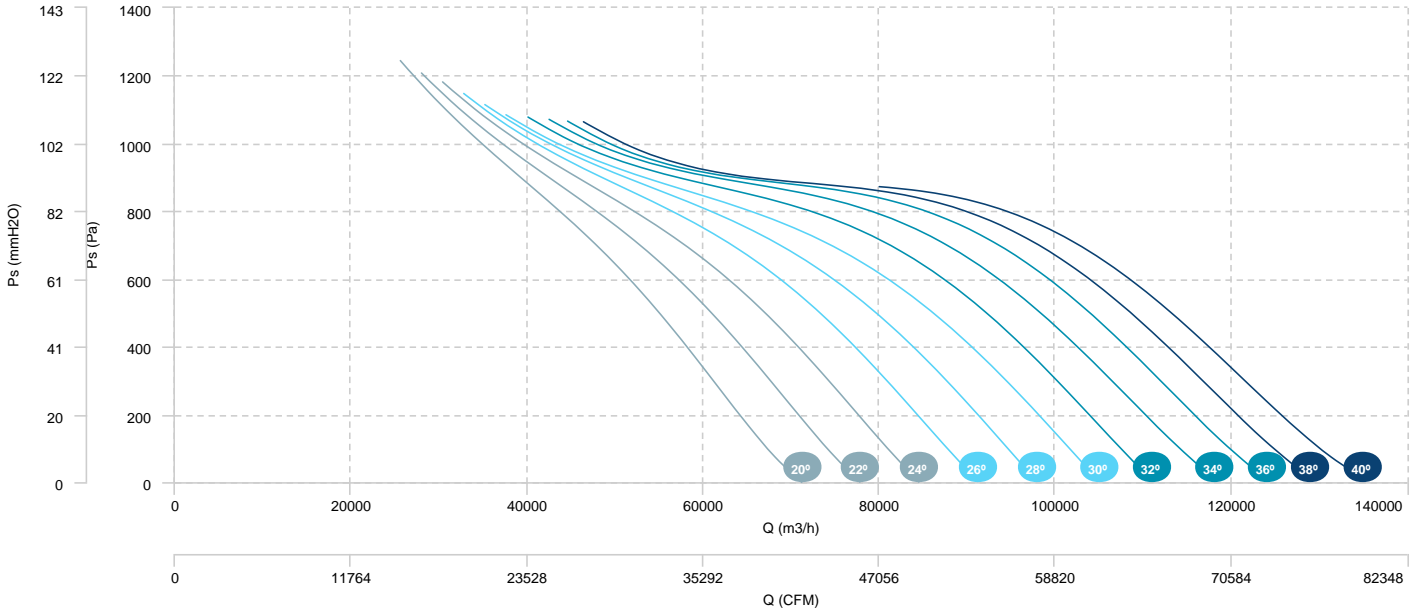

AIR FLOW - ABSORBED POWER (4 poles)

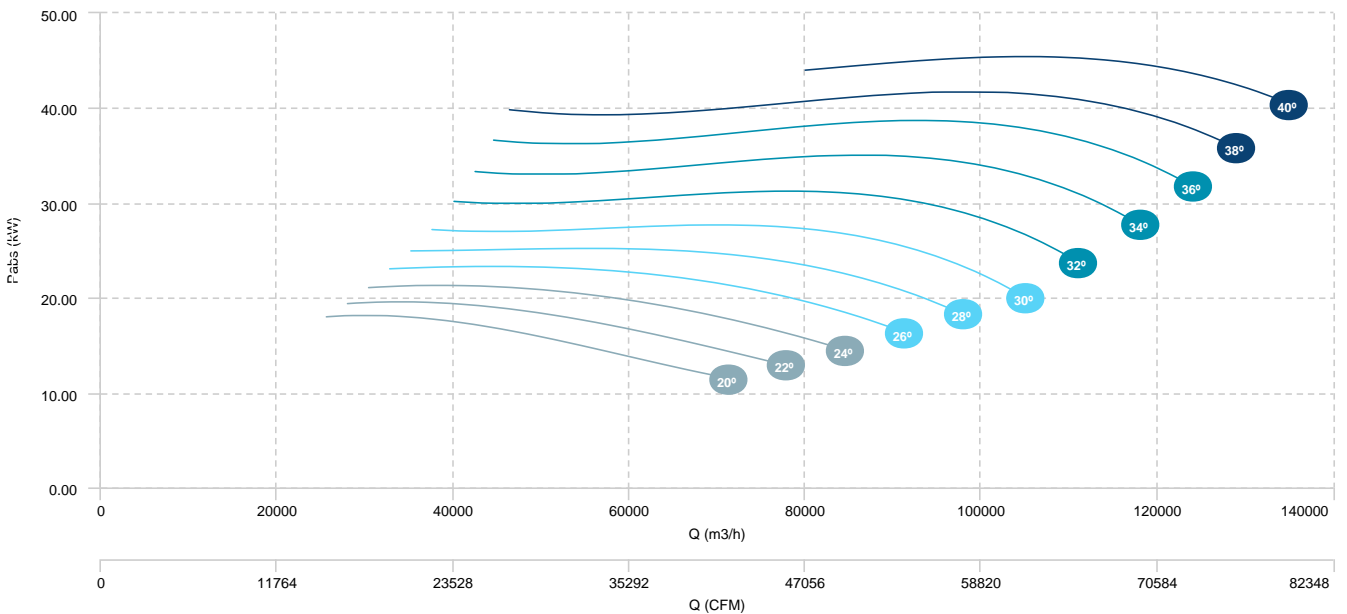

HMF 125 T4/T8 20/5kW (A3:8) F400	HMF 125 T4/T8 28/6,5kW (A3:8) F400	HMF 125 T4/T8 37/9,2kW (A3:8) F400
HMF 125 T4/T8 44/11kW (A3:8) F400		

AIR FLOW - PRESSURE (8 poles)

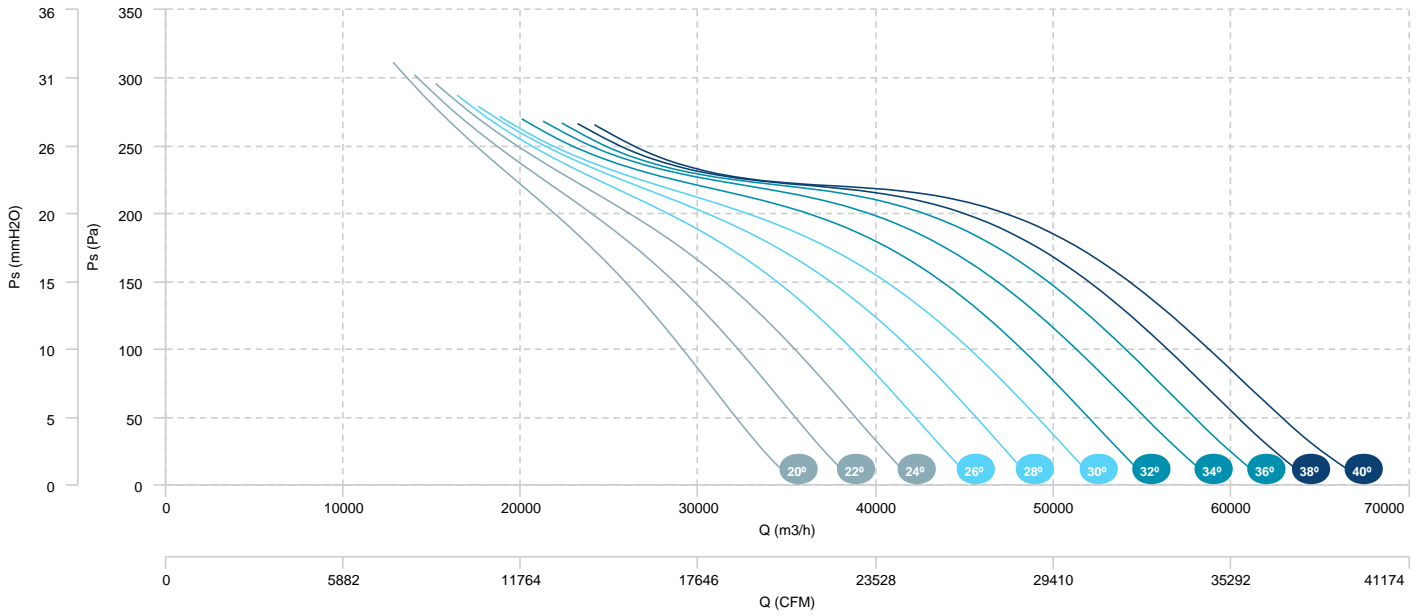

HMF 125 T4/T8 11/3kW (A3:4) F400	HMF 125 T4/T8 14/3,5kW (A3:4) F400	HMF 125 T4/T8 17/4,3kW (A3:4) F400
HMF 125 T4/T8 20/5kW (A3:4) F400	HMF 125 T4/T8 28/6,5kW (A3:4) F400	

AIR FLOW - PRESSURE (4 poles)

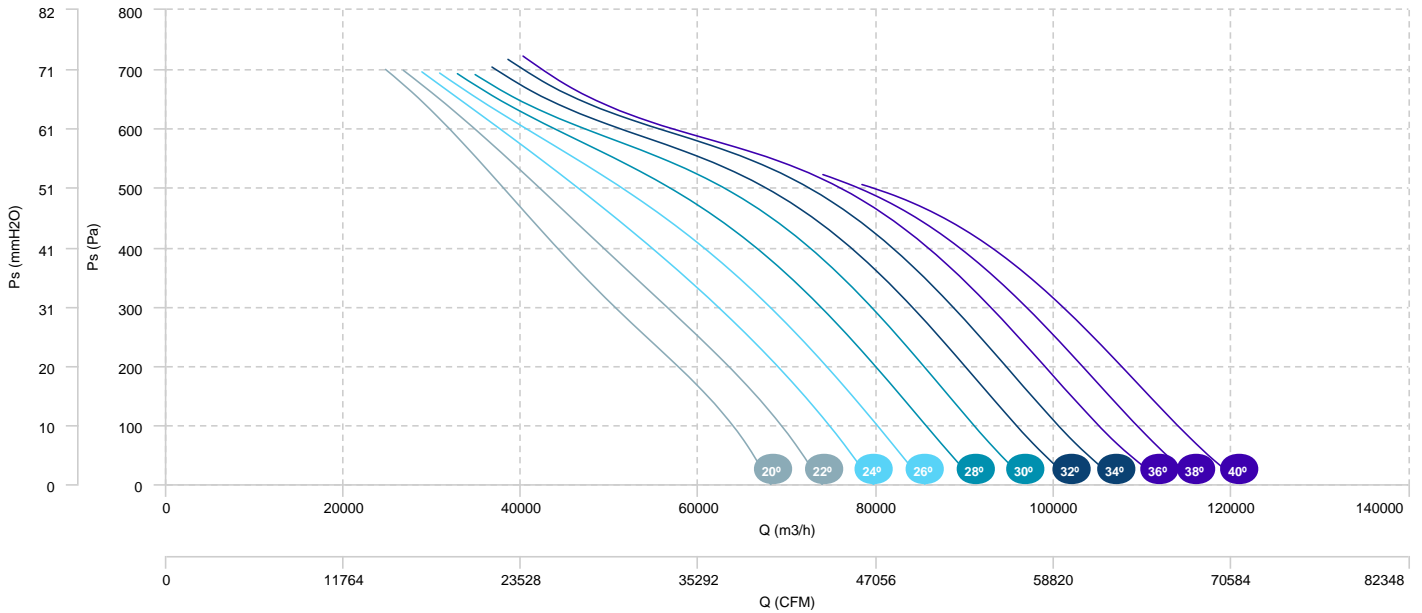

AIR FLOW - ABSORBED POWER (4 poles)

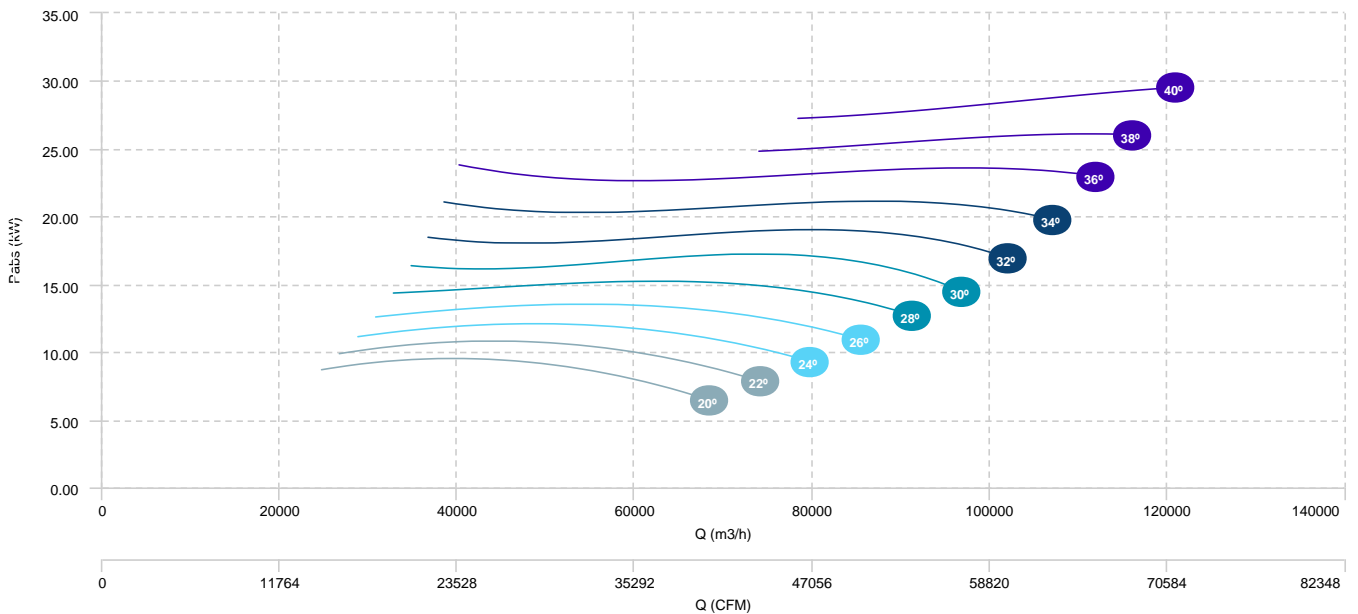

HMF 125 T4/T8 11/3kW (A3:4) F400	HMF 125 T4/T8 14/3,5kW (A3:4) F400	HMF 125 T4/T8 17/4,3kW (A3:4) F400
HMF 125 T4/T8 20/5kW (A3:4) F400	HMF 125 T4/T8 28/6,5kW (A3:4) F400	

AIR FLOW - PRESSURE (8 poles)

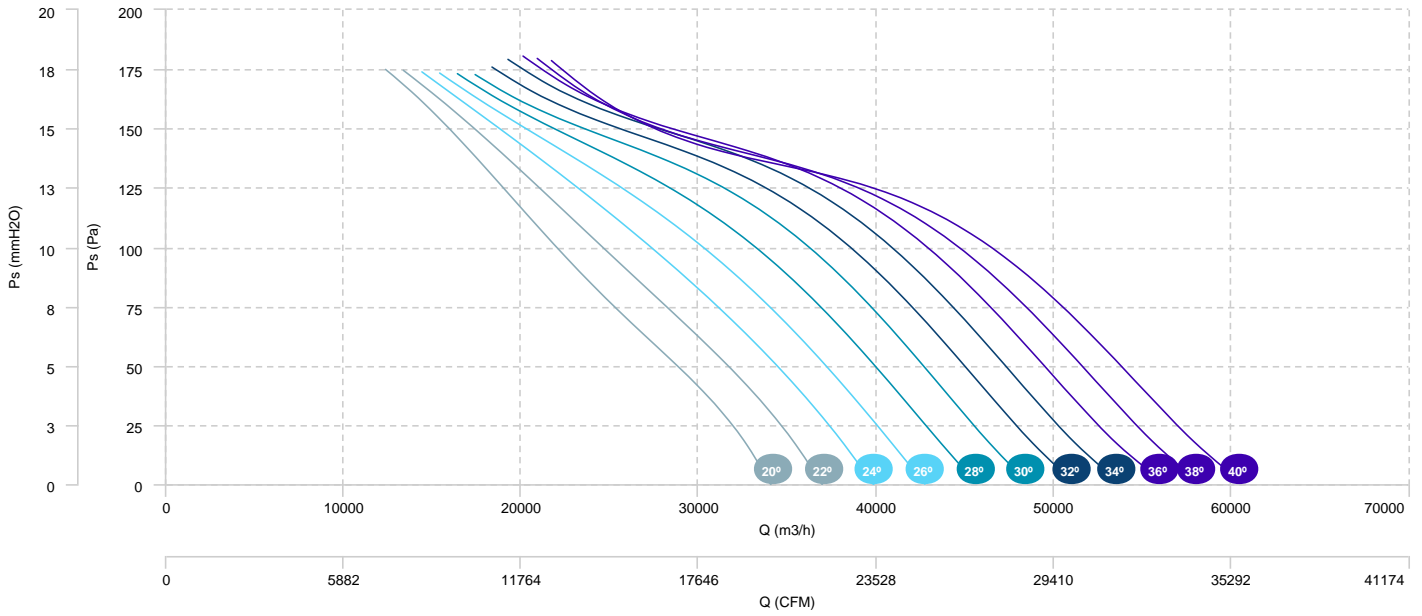

Sound data

Sound / 4 poles

Sound power Lw dB (A)										
Model		63 Hz	125 Hz	250 Hz	500 Hz	1000 Hz	2000 Hz	4000 Hz	8000 Hz	Total
HMF 45 T4 0,75kW (A5:6) F400 (40°)	Inlet	50	57	62	67	70	70	71	64	76
HMF 50 T4 0,75kW (A5:6) F400 (40°)	Inlet	53	60	65	69	72	71	72	66	78
HMF 56 T4 0,75kW (A5:6) F400 (25°)	Inlet	54	62	67	75	79	76	78	70	84
HMF 56 T4 0,75kW (A5:6) F400 (32.5°)	Inlet	54	61	66	75	75	76	79	70	83
HMF 56 T4 0,75kW (A5:6) F400 (30°)	Inlet	56	63	68	77	78	78	80	72	85
HMF 56 T4 1,1kW (A5:6) F400 (37.5°)	Inlet	54	61	66	75	74	76	78	69	82
HMF 56 T4 1,1kW (A5:6) F400 (35°)	Inlet	53	60	65	74	73	75	78	69	82
HMF 56 T4 1,5kW (A5:6) F400 (40°)	Inlet	56	63	68	76	75	76	79	70	83
HMF 56 T4 1,5kW (A5:6) F400 (42.5°)	Inlet	58	65	70	76	76	77	79	70	84
HMF 63 T4 0,75kW (A5:6) F400 (25°)	Inlet	57	66	71	80	80	79	80	75	86
HMF 63 T4 1,1kW (A5:6) F400 (30°)	Inlet	60	68	74	80	80	79	82	77	87
HMF 63 T4 1,5kW (A5:6) F400 (35°)	Inlet	59	67	72	75	76	76	79	73	83
HMF 63 T4 1,5kW (A5:6) F400 (32.5°)	Inlet	59	68	73	77	78	77	80	75	85
HMF 63 T4 2,2kW (A5:6) F400 (40°)	Inlet	60	67	72	77	78	78	80	73	85
HMF 63 T4 2,2kW (A5:6) F400 (37.5°)	Inlet	59	67	72	76	77	77	79	73	84
HMF 71 T4 0,75kW (A5:6) F400 (20°)	Inlet	55	66	71	86	85	82	84	76	91
HMF 71 T4 1,1kW (A5:6) F400 (25°)	Inlet	59	67	72	84	84	82	84	75	90
HMF 71 T4 1,5kW (A5:6) F400 (30°)	Inlet	61	68	73	82	82	83	84	73	89
HMF 71 T4 2,2kW (A5:6) F400 (35°)	Inlet	62	69	74	76	80	82	83	72	87
HMF 71 T4 2,2kW (A5:6) F400 (32.5°)	Inlet	62	69	74	79	81	83	84	73	88
HMF 71 T4 3kW (A5:6) F400 (40°)	Inlet	67	73	79	81	84	85	86	76	91
HMF 71 T4 3kW (A5:6) F400 (37.5°)	Inlet	65	71	77	79	82	84	85	74	89
HMF 80 T4 3kW (A5:6) F400 (35°)	Inlet	62	69	74	79	82	82	86	76	89
HMF 80 T4 3kW (A5:6) F400 (32.5°)	Inlet	63	70	75	81	85	84	88	80	91
HMF 80 T4 3kW (A5:6) F400 (30°)	Inlet	64	71	76	83	87	86	90	83	94
HMF 80 T4 4kW (A5:6) F400 (37.5°)	Inlet	64	71	76	80	83	83	86	76	90
HMF 80 T4 4kW (A5:6) F400 (40°)	Inlet	66	73	78	82	84	84	86	76	91
HMF 90 T4 3kW (A3:4) F400 (22°)	Inlet	61	69	74	83	87	87	86	77	92
HMF 90 T4 3kW (A3:4) F400 (20°)	Inlet	57	68	73	84	88	88	86	78	93
HMF 90 T4 4kW (A3:4) F400 (26°)	Inlet	64	71	76	83	85	85	84	76	91
HMF 90 T4 4kW (A3:4) F400 (24°)	Inlet	63	70	75	83	86	86	85	77	91
HMF 90 T4 5,5kW (A3:4) F400 (30°)	Inlet	66	73	78	83	83	83	83	75	89
HMF 90 T4 5,5kW (A3:4) F400 (28°)	Inlet	65	72	77	83	84	84	84	76	90
HMF 90 T4 5,5kW (A3:4) F400 (32°)	Inlet	66	73	78	82	83	83	83	75	89
HMF 90 T4 5,5kW (A3:8) F400 (22°)	Inlet	69	80	88	90	92	87	88	78	97

		Sound power Lw dB (A)								
Model		63 Hz	125 Hz	250 Hz	500 Hz	1000 Hz	2000 Hz	4000 Hz	8000 Hz	Total
HMF 90 T4 5,5kW (A3:8) F400 (20°)	Inlet	69	81	90	91	93	87	88	78	98
HMF 90 T4 5,5kW (A3:8) F400 (24°)	Inlet	69	79	86	89	91	88	88	78	96
HMF 90 T4 7,5kW (A3:4) F400 (34°)	Inlet	65	72	77	81	83	84	82	74	89
HMF 90 T4 7,5kW (A3:4) F400 (38°)	Inlet	67	74	79	82	85	84	83	76	91
HMF 90 T4 7,5kW (A3:4) F400 (36°)	Inlet	66	73	78	81	84	84	82	74	90
HMF 90 T4 7,5kW (A3:8) F400 (28°)	Inlet	70	76	82	87	89	88	87	79	94
HMF 90 T4 7,5kW (A3:8) F400 (26°)	Inlet	70	78	84	88	90	88	88	79	95
HMF 90 T4 11kW (A3:4) F400 (40°)	Inlet	68	75	80	83	87	85	84	77	91
HMF 90 T4 11kW (A3:8) F400 (36°)	Inlet	67	74	79	83	87	87	85	77	92
HMF 90 T4 11kW (A3:8) F400 (34°)	Inlet	67	74	79	84	87	87	85	77	92
HMF 90 T4 11kW (A3:8) F400 (32°)	Inlet	67	74	79	85	87	87	86	78	93
HMF 90 T4 11kW (A3:8) F400 (30°)	Inlet	68	75	80	86	88	88	87	79	94
HMF 90 T4 15kW (A3:8) F400 (40°)	Inlet	71	78	83	84	88	87	84	78	93
HMF 90 T4 15kW (A3:8) F400 (38°)	Inlet	69	76	81	84	87	87	84	77	92
HMF 100 T4 5,5kW (A3:4) F400 (26°)	Inlet	67	75	81	87	90	91	93	88	97
HMF 100 T4 5,5kW (A3:4) F400 (24°)	Inlet	67	76	81	87	91	92	93	89	98
HMF 100 T4 5,5kW (A3:4) F400 (22°)	Inlet	66	76	82	88	91	92	93	90	98
HMF 100 T4 5,5kW (A3:4) F400 (20°)	Inlet	66	76	81	88	91	92	93	90	98
HMF 100 T4 7,5kW (A3:4) F400 (30°)	Inlet	68	74	81	86	90	91	93	86	97
HMF 100 T4 7,5kW (A3:4) F400 (28°)	Inlet	67	75	81	86	90	91	93	87	97
HMF 100 T4 7,5kW (A3:8) F400 (20°)	Inlet	72	81	92	102	100	99	100	95	107
HMF 100 T4 11kW (A3:4) F400 (38°)	Inlet	68	74	81	86	89	90	92	85	96
HMF 100 T4 11kW (A3:4) F400 (36°)	Inlet	69	73	81	86	88	90	91	85	96
HMF 100 T4 11kW (A3:4) F400 (34°)	Inlet	69	73	81	85	88	90	91	85	96
HMF 100 T4 11kW (A3:4) F400 (32°)	Inlet	68	74	81	86	89	90	92	86	96
HMF 100 T4 11kW (A3:8) F400 (28°)	Inlet	72	79	87	93	96	95	96	91	102
HMF 100 T4 11kW (A3:8) F400 (24°)	Inlet	72	79	89	97	97	97	98	93	104
HMF 100 T4 11kW (A3:8) F400 (22°)	Inlet	72	80	91	100	99	98	99	94	106
HMF 100 T4 11kW (A3:8) F400 (26°)	Inlet	72	79	88	95	96	96	97	92	103
HMF 100 T4 15kW (A3:4) F400 (40°)	Inlet	68	75	81	87	90	91	92	86	97
HMF 100 T4 15kW (A3:8) F400 (34°)	Inlet	71	78	83	88	92	93	94	88	99
HMF 100 T4 15kW (A3:8) F400 (32°)	Inlet	71	79	84	90	93	94	95	89	100
HMF 100 T4 15kW (A3:8) F400 (30°)	Inlet	72	79	86	91	95	95	96	90	101
HMF 100 T4 18,5kW (A3:8) F400 (38°)	Inlet	71	78	83	88	92	94	94	88	99
HMF 100 T4 18,5kW (A3:8) F400 (36°)	Inlet	70	77	82	87	91	93	94	87	99
HMF 100 T4 22kW (A3:8) F400 (40°)	Inlet	71	79	84	89	92	94	95	89	100
HMF 112 T4 5,5kW (A3:4) F400 (20°)	Inlet	66	78	83	90	94	94	96	92	101
HMF 112 T4 7,5kW (A3:4) F400 (22°)	Inlet	68	79	84	90	94	95	96	92	102

Sound power Lw dB (A)										
Model		63 Hz	125 Hz	250 Hz	500 Hz	1000 Hz	2000 Hz	4000 Hz	8000 Hz	Total
HMF 112 T4 7,5kW (A3:4) F400 (24°)	Inlet	69	78	83	90	93	94	96	91	101
HMF 112 T4 11kW (A3:4) F400 (32°)	Inlet	70	77	82	87	91	92	94	87	98
HMF 112 T4 11kW (A3:4) F400 (30°)	Inlet	71	78	83	88	92	93	94	88	99
HMF 112 T4 11kW (A3:4) F400 (28°)	Inlet	71	78	83	89	92	93	95	89	99
HMF 112 T4 11kW (A3:4) F400 (26°)	Inlet	70	78	83	89	93	94	95	90	100
HMF 112 T4 11kW (A3:8) F400 (22°)	Inlet	73	81	91	99	100	102	102	96	107
HMF 112 T4 11kW (A3:8) F400 (20°)	Inlet	73	82	92	101	101	103	103	97	109
HMF 112 T4 15kW (A3:4) F400 (38°)	Inlet	71	77	83	88	91	92	93	87	98
HMF 112 T4 15kW (A3:4) F400 (34°)	Inlet	70	76	82	87	90	92	93	86	98
HMF 112 T4 15kW (A3:4) F400 (36°)	Inlet	71	76	83	87	90	92	93	86	98
HMF 112 T4 15kW (A3:8) F400 (26°)	Inlet	74	81	89	96	98	100	100	94	106
HMF 112 T4 15kW (A3:8) F400 (24°)	Inlet	73	81	90	97	99	101	101	95	106
HMF 112 T4 15kW (A3:8) F400 (28°)	Inlet	74	81	88	94	98	99	99	94	105
HMF 112 T4 18,5kW (A3:4) F400 (40°)	Inlet	72	79	84	89	91	93	94	87	99
HMF 112 T4 18,5kW (A3:8) F400 (32°)	Inlet	74	81	86	91	96	97	97	91	103
HMF 112 T4 18,5kW (A3:8) F400 (30°)	Inlet	74	80	87	93	97	99	99	93	104
HMF 112 T4 22kW (A3:8) F400 (34°)	Inlet	73	80	85	90	94	96	96	89	101
HMF 112 T4 22kW (A3:8) F400 (36°)	Inlet	73	80	85	90	93	95	95	89	101
HMF 112 T4 30kW (A3:8) F400 (40°)	Inlet	74	81	86	90	94	96	95	90	101
HMF 112 T4 30kW (A3:8) F400 (38°)	Inlet	73	80	85	90	94	96	95	89	101
HMF 125 T4 11kW (A3:4) F400 (22°)	Inlet	75	86	91	98	102	103	105	101	109
HMF 125 T4 11kW (A3:4) F400 (20°)	Inlet	72	85	90	98	102	102	104	101	109
HMF 125 T4 15kW (A3:4) F400 (28°)	Inlet	75	82	87	93	96	98	99	93	104
HMF 125 T4 15kW (A3:4) F400 (26°)	Inlet	76	84	89	94	98	99	101	95	106
HMF 125 T4 15kW (A3:4) F400 (24°)	Inlet	75	85	90	96	100	101	103	98	107
HMF 125 T4 18,5kW (A3:4) F400 (32°)	Inlet	74	81	86	90	94	96	96	90	102
HMF 125 T4 18,5kW (A3:4) F400 (30°)	Inlet	74	81	86	91	95	96	97	91	102
HMF 125 T4 18,5kW (A3:8) F400 (22°)	Inlet	79	86	93	102	107	110	109	104	114
HMF 125 T4 18,5kW (A3:8) F400 (20°)	Inlet	78	86	93	103	108	111	110	105	115
HMF 125 T4 22kW (A3:4) F400 (36°)	Inlet	74	81	86	90	93	95	96	88	101
HMF 125 T4 22kW (A3:4) F400 (34°)	Inlet	73	80	85	90	93	95	96	88	101
HMF 125 T4 22kW (A3:8) F400 (24°)	Inlet	78	85	92	100	106	108	108	102	113
HMF 125 T4 22kW (A3:8) F400 (26°)	Inlet	78	85	91	98	104	106	106	100	111
HMF 125 T4 30kW (A3:4) F400 (40°)	Inlet	75	82	87	91	93	96	96	89	102

Sound power Lw dB (A)											
Model		63 Hz	125 Hz	250 Hz	500 Hz	1000 Hz	2000 Hz	4000 Hz	8000 Hz	Total	
HMF 125 T4 30kW (A3:4) F400 (38°)	Inlet	74	81	86	91	93	95	96	89	101	
HMF 125 T4 30kW (A3:8) F400 (30°)	Inlet	77	83	90	96	101	103	104	97	108	
HMF 125 T4 30kW (A3:8) F400 (28°)	Inlet	78	84	91	97	102	105	105	98	110	
HMF 125 T4 30kW (A3:8) F400 (32°)	Inlet	77	83	89	95	99	102	102	94	107	
HMF 125 T4 37kW (A3:8) F400 (36°)	Inlet	77	83	89	93	96	98	98	91	104	
HMF 125 T4 37kW (A3:8) F400 (34°)	Inlet	77	83	89	94	97	99	100	92	105	
HMF 125 T4 45kW (A3:8) F400 (40°)	Inlet	76	83	88	93	96	98	97	90	103	
HMF 125 T4 45kW (A3:8) F400 (38°)	Inlet	76	83	88	93	96	98	97	91	104	

Sound / 6 poles

Sound power Lw dB (A)											
Model		63 Hz	125 Hz	250 Hz	500 Hz	1000 Hz	2000 Hz	4000 Hz	8000 Hz	Total	
HMF 50 T6 0,75kW (A5:6) F400 (40°)	Inlet	44	51	56	60	63	62	64	57	69	
HMF 56 T6 0,75kW (A5:6) F400 (40°)	Inlet	47	54	59	67	66	67	70	61	74	
HMF 63 T6 0,75kW (A5:6) F400 (40°)	Inlet	51	58	63	68	69	69	71	64	76	
HMF 71 T6 0,75kW (A5:6) F400 (40°)	Inlet	59	65	71	73	76	77	78	68	83	
HMF 71 T6 0,75kW (A5:6) F400 (37.5°)	Inlet	56	63	68	70	73	75	76	65	81	
HMF 71 T6 0,75kW (A5:6) F400 (35°)	Inlet	54	61	66	67	71	73	74	63	79	
HMF 80 T6 0,75kW (A5:6) F400 (30°)	Inlet	55	62	67	74	78	77	81	74	85	
HMF 80 T6 1,1kW (A5:6) F400 (32.5°)	Inlet	54	61	66	72	76	75	79	71	83	
HMF 80 T6 1,1kW (A5:6) F400 (35°)	Inlet	53	60	65	70	73	74	77	67	81	
HMF 80 T6 1,5kW (A5:6) F400 (37.5°)	Inlet	55	62	67	71	74	75	77	68	81	
HMF 80 T6 1,5kW (A5:6) F400 (40°)	Inlet	57	64	69	73	75	76	77	68	82	
HMF 80 T6 2,2kW (A5:6) F400 (42.5°)	Inlet	58	65	70	74	76	76	77	68	82	
HMF 90 T6 1,5kW (A3:4) F400 (20°)	Inlet	47	58	63	74	78	78	77	69	83	
HMF 90 T6 1,5kW (A3:4) F400 (26°)	Inlet	55	62	67	74	75	75	75	67	81	
HMF 90 T6 1,5kW (A3:4) F400 (22°)	Inlet	51	60	65	74	77	77	76	68	83	
HMF 90 T6 1,5kW (A3:4) F400 (30°)	Inlet	57	64	69	73	73	73	74	66	80	
HMF 90 T6 1,5kW (A3:4) F400 (24°)	Inlet	54	61	66	74	76	76	76	67	82	
HMF 90 T6 1,5kW (A3:4) F400 (32°)	Inlet	57	64	69	73	74	74	73	65	80	
HMF 90 T6 1,5kW (A3:4) F400 (28°)	Inlet	56	63	68	73	74	74	74	66	81	
HMF 90 T6 1,5kW (A3:8) F400 (24°)	Inlet	60	69	77	80	82	78	78	69	86	
HMF 90 T6 1,5kW (A3:8) F400 (22°)	Inlet	60	71	79	81	83	78	78	69	87	
HMF 90 T6 1,5kW (A3:8) F400 (20°)	Inlet	60	72	81	82	84	78	79	69	88	
HMF 90 T6 2,2kW (A3:4) F400 (36°)	Inlet	56	63	68	72	75	75	73	65	80	
HMF 90 T6 2,2kW (A3:4) F400 (40°)	Inlet	59	66	71	73	77	75	74	67	82	
HMF 90 T6 2,2kW (A3:4) F400 (38°)	Inlet	58	65	70	73	76	75	74	66	81	

		Sound power Lw dB (A)								
Model		63 Hz	125 Hz	250 Hz	500 Hz	1000 Hz	2000 Hz	4000 Hz	8000 Hz	Total
HMF 90 T6 2,2kW (A3:4) F400 (34°)	Inlet	56	63	68	72	74	74	73	65	80
HMF 90 T6 2,2kW (A3:8) F400 (30°)	Inlet	59	66	71	77	79	79	78	70	84
HMF 90 T6 2,2kW (A3:8) F400 (28°)	Inlet	60	67	73	78	80	78	78	70	85
HMF 90 T6 2,2kW (A3:8) F400 (26°)	Inlet	60	68	75	79	81	78	78	69	86
HMF 90 T6 3kW (A3:8) F400 (36°)	Inlet	58	65	70	74	77	77	75	68	83
HMF 90 T6 3kW (A3:8) F400 (34°)	Inlet	57	64	69	74	77	78	76	68	83
HMF 90 T6 3kW (A3:8) F400 (32°)	Inlet	58	65	70	76	78	78	77	69	84
HMF 90 T6 4kW (A3:8) F400 (40°)	Inlet	61	68	73	75	79	78	75	68	84
HMF 90 T6 4kW (A3:8) F400 (38°)	Inlet	59	66	71	74	78	78	75	68	83
HMF 100 T6 1,5kW (A3:4) F400 (26°)	Inlet	57	66	71	77	81	82	83	78	88
HMF 100 T6 1,5kW (A3:4) F400 (20°)	Inlet	56	67	72	78	82	83	84	81	89
HMF 100 T6 1,5kW (A3:4) F400 (24°)	Inlet	57	66	72	78	82	82	84	79	89
HMF 100 T6 1,5kW (A3:4) F400 (22°)	Inlet	57	67	72	78	82	83	84	80	89
HMF 100 T6 2,2kW (A3:4) F400 (26°)	Inlet	57	66	71	77	81	82	83	78	88
HMF 100 T6 2,2kW (A3:4) F400 (20°)	Inlet	56	67	72	78	82	83	84	81	89
HMF 100 T6 2,2kW (A3:4) F400 (32°)	Inlet	59	64	71	76	79	81	83	76	87
HMF 100 T6 2,2kW (A3:4) F400 (30°)	Inlet	58	65	71	77	80	81	83	77	87
HMF 100 T6 2,2kW (A3:4) F400 (28°)	Inlet	58	65	71	77	81	81	83	78	88
HMF 100 T6 2,2kW (A3:4) F400 (24°)	Inlet	57	66	72	78	82	82	84	79	89
HMF 100 T6 2,2kW (A3:4) F400 (22°)	Inlet	57	67	72	78	82	83	84	80	89
HMF 100 T6 2,2kW (A3:8) F400 (22°)	Inlet	63	71	82	90	89	88	89	85	96
HMF 100 T6 2,2kW (A3:8) F400 (20°)	Inlet	63	71	83	92	91	89	90	86	97
HMF 100 T6 3kW (A3:4) F400 (38°)	Inlet	59	65	72	77	80	81	82	76	87
HMF 100 T6 3kW (A3:4) F400 (34°)	Inlet	59	63	71	76	79	80	82	76	86
HMF 100 T6 3kW (A3:4) F400 (36°)	Inlet	59	64	71	76	79	80	82	76	86
HMF 100 T6 3kW (A3:8) F400 (24°)	Inlet	62	70	80	88	88	87	88	83	94
HMF 100 T6 3kW (A3:8) F400 (28°)	Inlet	62	70	78	84	86	86	87	81	92
HMF 100 T6 3kW (A3:8) F400 (26°)	Inlet	62	70	79	86	87	87	87	82	93
HMF 100 T6 4kW (A3:4) F400 (40°)	Inlet	59	66	72	77	81	81	83	76	87
HMF 100 T6 4kW (A3:8) F400 (34°)	Inlet	61	68	73	78	82	84	85	78	89
HMF 100 T6 4kW (A3:8) F400 (32°)	Inlet	62	69	75	80	84	85	85	79	90
HMF 100 T6 4kW (A3:8) F400 (30°)	Inlet	62	69	77	82	85	86	86	80	92
HMF 100 T6 5,5kW (A3:8) F400 (36°)	Inlet	61	68	73	78	82	84	84	78	89
HMF 100 T6 5,5kW (A3:8) F400 (40°)	Inlet	62	69	74	79	83	85	85	79	90
HMF 100 T6 5,5kW (A3:8) F400 (38°)	Inlet	61	68	73	79	82	84	85	79	90
HMF 112 T6 2,2kW (A3:4) F400 (26°)	Inlet	60	69	74	80	83	84	86	80	90
HMF 112 T6 2,2kW (A3:4) F400 (24°)	Inlet	59	69	74	80	84	85	86	81	91
HMF 112 T6 2,2kW (A3:4) F400 (22°)	Inlet	58	69	74	81	85	85	87	82	92
HMF 112 T6 2,2kW (A3:4) F400 (20°)	Inlet	56	68	73	80	84	85	87	82	91

Sound power Lw dB (A)										
Model		63 Hz	125 Hz	250 Hz	500 Hz	1000 Hz	2000 Hz	4000 Hz	8000 Hz	Total
HMF 112 T6 3kW (A3:4) F400 (28°)	Inlet	61	68	73	79	83	84	85	79	90
HMF 112 T6 3kW (A3:4) F400 (32°)	Inlet	61	67	73	78	81	83	84	78	89
HMF 112 T6 3kW (A3:4) F400 (30°)	Inlet	61	68	73	79	82	83	85	78	89
HMF 112 T6 3kW (A3:8) F400 (22°)	Inlet	64	72	81	89	90	92	92	87	98
HMF 112 T6 3kW (A3:8) F400 (20°)	Inlet	64	72	82	91	91	93	93	88	99
HMF 112 T6 4kW (A3:4) F400 (38°)	Inlet	62	68	74	78	81	83	84	77	89
HMF 112 T6 4kW (A3:4) F400 (36°)	Inlet	61	67	73	78	81	82	84	77	88
HMF 112 T6 4kW (A3:4) F400 (34°)	Inlet	61	66	73	78	81	82	84	77	88
HMF 112 T6 4kW (A3:8) F400 (28°)	Inlet	64	71	79	85	89	90	90	84	95
HMF 112 T6 4kW (A3:8) F400 (26°)	Inlet	64	71	79	86	89	90	90	85	96
HMF 112 T6 4kW (A3:8) F400 (24°)	Inlet	64	71	80	88	90	91	91	86	96
HMF 112 T6 5,5kW (A3:4) F400 (40°)	Inlet	63	69	75	79	82	84	84	78	89
HMF 112 T6 5,5kW (A3:8) F400 (30°)	Inlet	65	71	78	83	88	89	89	84	94
HMF 112 T6 5,5kW (A3:8) F400 (34°)	Inlet	64	71	76	81	84	86	87	80	92
HMF 112 T6 5,5kW (A3:8) F400 (32°)	Inlet	64	71	77	82	86	88	88	82	93
HMF 112 T6 7,5kW (A3:8) F400 (38°)	Inlet	64	71	76	81	84	86	86	80	91
HMF 112 T6 7,5kW (A3:8) F400 (36°)	Inlet	63	70	75	80	84	86	86	79	91
HMF 112 T6 7,5kW (A3:8) F400 (40°)	Inlet	64	71	76	81	85	87	86	80	92
HMF 125 T6 3kW (A3:4) F400 (24°)	Inlet	66	75	80	87	90	91	93	88	98
HMF 125 T6 3kW (A3:4) F400 (22°)	Inlet	65	77	82	89	92	93	95	91	99
HMF 125 T6 3kW (A3:4) F400 (20°)	Inlet	63	76	81	89	92	92	94	91	99
HMF 125 T6 4kW (A3:4) F400 (26°)	Inlet	66	74	79	85	89	90	91	86	96
HMF 125 T6 4kW (A3:4) F400 (28°)	Inlet	66	73	78	83	87	88	89	84	94
HMF 125 T6 5,5kW (A3:4) F400 (34°)	Inlet	64	71	76	81	84	85	86	79	91
HMF 125 T6 5,5kW (A3:4) F400 (32°)	Inlet	64	71	76	81	84	86	87	80	92
HMF 125 T6 5,5kW (A3:4) F400 (30°)	Inlet	65	72	77	81	85	87	88	81	92
HMF 125 T6 5,5kW (A3:8) F400 (24°)	Inlet	69	76	83	90	96	98	98	92	103
HMF 125 T6 5,5kW (A3:8) F400 (22°)	Inlet	69	77	84	92	97	100	99	94	105
HMF 125 T6 5,5kW (A3:8) F400 (20°)	Inlet	69	77	84	93	98	101	101	95	106
HMF 125 T6 7,5kW (A3:4) F400 (40°)	Inlet	65	72	77	82	84	86	87	80	92
HMF 125 T6 7,5kW (A3:4) F400 (38°)	Inlet	65	72	77	81	84	86	86	79	91
HMF 125 T6 7,5kW (A3:4) F400 (36°)	Inlet	64	71	76	81	83	85	86	79	91
HMF 125 T6 7,5kW (A3:8) F400 (30°)	Inlet	68	74	80	86	91	93	94	87	98
HMF 125 T6 7,5kW (A3:8) F400 (28°)	Inlet	68	74	81	87	93	95	95	89	100
HMF 125 T6 7,5kW (A3:8) F400 (26°)	Inlet	69	75	82	89	94	97	96	90	102
HMF 125 T6 11kW (A3:8) F400 (38°)	Inlet	67	74	79	84	87	89	88	81	94
HMF 125 T6 11kW (A3:8) F400 (36°)	Inlet	67	74	79	84	87	89	89	82	94
HMF 125 T6 11kW (A3:8) F400 (34°)	Inlet	68	74	80	84	88	90	90	83	95
HMF 125 T6 11kW (A3:8) F400 (32°)	Inlet	68	74	80	85	90	92	92	85	97

Sound power Lw dB (A)										
Model		63 Hz	125 Hz	250 Hz	500 Hz	1000 Hz	2000 Hz	4000 Hz	8000 Hz	Total
HMF 125 T6 15kW (A3:8) F400 (40°)	Inlet	67	74	79	83	87	89	87	81	93

Sound / 4/6 poles

Sound power Lw dB (A)										
Model		63 Hz	125 Hz	250 Hz	500 Hz	1000 Hz	2000 Hz	4000 Hz	8000 Hz	Total
HMF 45 T4/T6 0,75/0,25kW (A5:6) F400 (1500 RPM - 40°)	Inlet	50	57	62	67	70	70	71	64	76
HMF 50 T4/T6 0,75/0,25kW (A5:6) F400 (1500 RPM - 40°)	Inlet	53	60	65	69	72	71	72	66	78
HMF 56 T4/T6 0,75/0,25kW (A5:6) F400 (1500 RPM - 32.5°)	Inlet	54	61	66	75	75	76	79	70	83
HMF 56 T4/T6 0,75/0,25kW (A5:6) F400 (1500 RPM - 30°)	Inlet	56	63	68	77	78	78	80	72	85
HMF 56 T4/T6 0,75/0,25kW (A5:6) F400 (1500 RPM - 25°)	Inlet	54	62	67	75	79	76	78	70	84
HMF 56 T4/T6 1,1/0,3kW (A5:6) F400 (1500 RPM - 37.5°)	Inlet	54	61	66	75	74	76	78	69	82
HMF 56 T4/T6 1,1/0,3kW (A5:6) F400 (1500 RPM - 35°)	Inlet	53	60	65	74	73	75	78	69	82
HMF 56 T4/T6 1,5/0,37kW (A5:6) F400 (1500 RPM - 42.5°)	Inlet	58	65	70	76	76	77	79	70	84
HMF 56 T4/T6 1,5/0,37kW (A5:6) F400 (1500 RPM - 40°)	Inlet	56	63	68	76	75	76	79	70	83
HMF 63 T4/T6 0,75/0,25kW (A5:6) F400 (1500 RPM - 25°)	Inlet	57	66	71	80	80	79	80	75	86
HMF 63 T4/T6 1,1/0,3kW (A5:6) F400 (1500 RPM - 30°)	Inlet	60	68	74	80	80	79	82	77	87
HMF 63 T4/T6 1,5/0,37kW (A5:6) F400 (1500 RPM - 35°)	Inlet	59	67	72	75	76	76	79	73	83
HMF 63 T4/T6 1,5/0,37kW (A5:6) F400 (1500 RPM - 32.5°)	Inlet	59	68	73	77	78	77	80	75	85
HMF 63 T4/T6 2,2/0,7kW (A5:6) F400 (1500 RPM - 40°)	Inlet	60	67	72	77	78	78	80	73	85
HMF 63 T4/T6 2,2/0,7kW (A5:6) F400 (1500 RPM - 37.5°)	Inlet	59	67	72	76	77	77	79	73	84
HMF 71 T4/T6 0,75/0,25kW (A5:6) F400 (1500 RPM - 20°)	Inlet	55	66	71	86	85	82	84	76	91
HMF 71 T4/T6 1,1/0,3kW (A5:6) F400 (1500 RPM - 25°)	Inlet	59	67	72	84	84	82	84	75	90
HMF 71 T4/T6 1,5/0,37kW (A5:6) F400 (1500 RPM - 30°)	Inlet	61	68	73	82	82	83	84	73	89
HMF 71 T4/T6 2,2/0,7kW (A5:6) F400 (1500 RPM - 35°)	Inlet	62	69	74	76	80	82	83	72	87

Sound power Lw dB (A)										
Model		63 Hz	125 Hz	250 Hz	500 Hz	1000 Hz	2000 Hz	4000 Hz	8000 Hz	Total
HMF 71 T4/T6 2,2/0,7kW (A5:6) F400 (1500 RPM - 32.5°)	Inlet	62	69	74	79	81	83	84	73	88
HMF 71 T4/T6 3/1kW (A5:6) F400 (1500 RPM - 40°)	Inlet	67	73	79	81	84	85	86	76	91
HMF 71 T4/T6 3/1kW (A5:6) F400 (1500 RPM - 37.5°)	Inlet	65	71	77	79	82	84	85	74	89
HMF 80 T4/T6 3/1kW (A5:6) F400 (1500 RPM - 35°)	Inlet	62	69	74	79	82	82	86	76	89
HMF 80 T4/T6 3/1kW (A5:6) F400 (1500 RPM - 32.5°)	Inlet	63	70	75	81	85	84	88	80	91
HMF 80 T4/T6 3/1kW (A5:6) F400 (1500 RPM - 30°)	Inlet	64	71	76	83	87	86	90	83	94
HMF 80 T4/T6 4,5/1,5kW (A5:6) F400 (1500 RPM - 37.5°)	Inlet	64	71	76	80	83	83	86	76	90
HMF 80 T4/T6 4,5/1,5kW (A5:6) F400 (1500 RPM - 40°)	Inlet	66	73	78	82	84	84	86	76	91
HMF 90 T4/T6 3/1kW (A3:4) F400 (1420 RPM - 22°)	Inlet	61	69	74	83	87	87	86	77	92
HMF 90 T4/T6 3/1kW (A3:4) F400 (1420 RPM - 20°)	Inlet	57	68	73	84	88	88	86	78	93
HMF 90 T4/T6 3/1kW (A3:4) F400 (920 RPM - 22°)	Inlet	51	60	65	74	77	77	76	68	83
HMF 90 T4/T6 3/1kW (A3:4) F400 (920 RPM - 20°)	Inlet	47	59	64	74	78	78	77	69	83
HMF 90 T4/T6 4,5/1,5kW (A3:4) F400 (1420 RPM - 28°)	Inlet	65	72	77	83	84	84	84	76	90
HMF 90 T4/T6 4,5/1,5kW (A3:4) F400 (920 RPM - 28°)	Inlet	56	63	68	73	74	74	74	67	81
HMF 90 T4/T6 4,5/1,5kW (A3:4) F400 (920 RPM - 26°)	Inlet	55	62	67	74	75	75	75	67	81
HMF 90 T4/T6 4,5/1,5kW (A3:4) F400 (1420 RPM - 26°)	Inlet	64	71	76	83	85	85	84	76	91
HMF 90 T4/T6 4,5/1,5kW (A3:4) F400 (1420 RPM - 24°)	Inlet	63	70	75	83	86	86	85	77	91
HMF 90 T4/T6 4,5/1,5kW (A3:4) F400 (920 RPM - 24°)	Inlet	54	61	66	74	76	76	76	68	82
HMF 90 T4/T6 4,5/1,5kW (A3:8) F400 (1420 RPM - 20°)	Inlet	69	81	90	91	93	87	88	78	98
HMF 90 T4/T6 4,5/1,5kW (A3:8) F400 (920 RPM - 20°)	Inlet	60	72	81	82	84	78	79	69	88
HMF 90 T4/T6 6/2,2kW (A3:4) F400 (1420 RPM - 34°)	Inlet	65	72	77	81	83	84	82	74	89
HMF 90 T4/T6 6/2,2kW (A3:4) F400 (1420 RPM - 30°)	Inlet	66	73	78	83	83	83	83	75	89
HMF 90 T4/T6 6/2,2kW (A3:4) F400 (920 RPM - 34°)	Inlet	56	63	68	72	74	74	73	65	80

		Sound power Lw dB (A)								
Model		63 Hz	125 Hz	250 Hz	500 Hz	1000 Hz	2000 Hz	4000 Hz	8000 Hz	Total
HMF 90 T4/T6 6/2,2kW (A3:4) F400 (920 RPM - 30°)	Inlet	57	64	69	73	73	73	74	66	80
HMF 90 T4/T6 6/2,2kW (A3:4) F400 (1420 RPM - 32°)	Inlet	66	73	78	82	83	83	83	75	89
HMF 90 T4/T6 6/2,2kW (A3:4) F400 (920 RPM - 32°)	Inlet	57	64	69	73	74	74	73	65	80
HMF 90 T4/T6 6/2,2kW (A3:8) F400 (1420 RPM - 22°)	Inlet	69	80	88	90	92	87	88	78	97
HMF 90 T4/T6 6/2,2kW (A3:8) F400 (920 RPM - 24°)	Inlet	60	69	77	80	82	78	78	69	87
HMF 90 T4/T6 6/2,2kW (A3:8) F400 (920 RPM - 22°)	Inlet	60	71	79	81	83	78	79	69	87
HMF 90 T4/T6 6/2,2kW (A3:8) F400 (1420 RPM - 24°)	Inlet	69	79	86	89	91	88	88	78	96
HMF 90 T4/T6 10/3,3kW (A3:4) F400 (920 RPM - 40°)	Inlet	59	66	71	73	77	75	74	67	82
HMF 90 T4/T6 10/3,3kW (A3:4) F400 (920 RPM - 36°)	Inlet	57	64	69	72	75	75	73	65	80
HMF 90 T4/T6 10/3,3kW (A3:4) F400 (1420 RPM - 40°)	Inlet	68	75	80	83	87	85	84	77	91
HMF 90 T4/T6 10/3,3kW (A3:4) F400 (1420 RPM - 38°)	Inlet	67	74	79	82	85	84	83	76	91
HMF 90 T4/T6 10/3,3kW (A3:4) F400 (1420 RPM - 36°)	Inlet	66	73	78	81	84	84	82	74	90
HMF 90 T4/T6 10/3,3kW (A3:4) F400 (920 RPM - 38°)	Inlet	58	65	70	73	76	75	74	66	81
HMF 90 T4/T6 10/3,3kW (A3:8) F400 (1420 RPM - 34°)	Inlet	67	74	79	84	87	87	85	77	92
HMF 90 T4/T6 10/3,3kW (A3:8) F400 (1420 RPM - 28°)	Inlet	70	76	82	87	89	88	87	79	94
HMF 90 T4/T6 10/3,3kW (A3:8) F400 (1420 RPM - 26°)	Inlet	70	78	84	88	90	88	88	79	95
HMF 90 T4/T6 10/3,3kW (A3:8) F400 (920 RPM - 32°)	Inlet	58	65	70	76	78	78	77	69	84
HMF 90 T4/T6 10/3,3kW (A3:8) F400 (920 RPM - 28°)	Inlet	60	67	73	78	80	79	78	70	85
HMF 90 T4/T6 10/3,3kW (A3:8) F400 (1420 RPM - 32°)	Inlet	67	74	79	85	87	87	86	78	93
HMF 90 T4/T6 10/3,3kW (A3:8) F400 (1420 RPM - 30°)	Inlet	68	75	80	86	88	88	87	79	94
HMF 90 T4/T6 10/3,3kW (A3:8) F400 (920 RPM - 34°)	Inlet	57	64	69	75	77	78	76	68	83
HMF 90 T4/T6 10/3,3kW (A3:8) F400 (920 RPM - 30°)	Inlet	59	66	71	77	79	79	78	70	85
HMF 90 T4/T6 10/3,3kW (A3:8) F400 (920 RPM - 26°)	Inlet	60	68	75	79	81	78	78	69	86

		Sound power Lw dB (A)								
Model		63 Hz	125 Hz	250 Hz	500 Hz	1000 Hz	2000 Hz	4000 Hz	8000 Hz	Total
HMF 90 T4/T6 14/4,5kW (A3:8) F400 (1420 RPM - 36°)	Inlet	67	74	79	83	87	87	85	77	92
HMF 90 T4/T6 14/4,5kW (A3:8) F400 (920 RPM - 40°)	Inlet	61	68	73	75	79	78	75	68	84
HMF 90 T4/T6 14/4,5kW (A3:8) F400 (920 RPM - 38°)	Inlet	60	67	72	74	78	78	75	68	83
HMF 90 T4/T6 14/4,5kW (A3:8) F400 (920 RPM - 36°)	Inlet	58	65	70	74	77	77	75	68	83
HMF 90 T4/T6 14/4,5kW (A3:8) F400 (1420 RPM - 40°)	Inlet	71	78	83	84	88	87	84	78	93
HMF 90 T4/T6 14/4,5kW (A3:8) F400 (1420 RPM - 38°)	Inlet	69	76	81	84	87	87	84	77	92
HMF 100 T4/T6 4,5/1,5kW (A3:4) F400 (1420 RPM - 22°)	Inlet	66	76	82	88	91	92	93	90	98
HMF 100 T4/T6 4,5/1,5kW (A3:4) F400 (920 RPM - 22°)	Inlet	57	67	72	79	82	83	84	80	89
HMF 100 T4/T6 4,5/1,5kW (A3:4) F400 (920 RPM - 20°)	Inlet	56	67	72	79	82	83	84	81	89
HMF 100 T4/T6 4,5/1,5kW (A3:4) F400 (1420 RPM - 20°)	Inlet	66	76	81	88	91	92	93	90	98
HMF 100 T4/T6 6/2,2kW (A3:4) F400 (1420 RPM - 26°)	Inlet	67	75	81	87	90	91	93	88	97
HMF 100 T4/T6 6/2,2kW (A3:4) F400 (1420 RPM - 24°)	Inlet	67	76	81	87	91	92	93	89	98
HMF 100 T4/T6 6/2,2kW (A3:4) F400 (920 RPM - 26°)	Inlet	57	66	72	77	81	82	84	78	88
HMF 100 T4/T6 6/2,2kW (A3:4) F400 (920 RPM - 24°)	Inlet	57	66	72	78	82	83	84	80	89
HMF 100 T4/T6 10/3,3kW (A3:4) F400 (1420 RPM - 30°)	Inlet	68	74	81	86	90	91	93	86	97
HMF 100 T4/T6 10/3,3kW (A3:4) F400 (920 RPM - 36°)	Inlet	59	64	72	76	79	81	82	76	87
HMF 100 T4/T6 10/3,3kW (A3:4) F400 (920 RPM - 32°)	Inlet	59	64	71	76	80	81	83	76	87
HMF 100 T4/T6 10/3,3kW (A3:4) F400 (1420 RPM - 36°)	Inlet	69	73	81	86	88	90	91	85	96
HMF 100 T4/T6 10/3,3kW (A3:4) F400 (1420 RPM - 34°)	Inlet	69	73	81	85	88	90	91	85	96
HMF 100 T4/T6 10/3,3kW (A3:4) F400 (1420 RPM - 32°)	Inlet	68	74	81	86	89	90	92	86	96
HMF 100 T4/T6 10/3,3kW (A3:4) F400 (1420 RPM - 28°)	Inlet	67	75	81	86	90	91	93	87	97
HMF 100 T4/T6 10/3,3kW (A3:4) F400 (920 RPM - 34°)	Inlet	59	64	71	76	79	81	82	76	87
HMF 100 T4/T6 10/3,3kW (A3:4) F400 (920 RPM - 30°)	Inlet	58	65	71	77	80	81	83	77	88

Sound power Lw dB (A)										
Model		63 Hz	125 Hz	250 Hz	500 Hz	1000 Hz	2000 Hz	4000 Hz	8000 Hz	Total
HMF 100 T4/T6 10/3,3kW (A3:4) F400 (920 RPM - 28°)	Inlet	58	65	71	77	81	82	83	78	88
HMF 100 T4/T6 10/3,3kW (A3:8) F400 (1420 RPM - 24°)	Inlet	72	79	89	97	97	97	98	93	104
HMF 100 T4/T6 10/3,3kW (A3:8) F400 (1420 RPM - 22°)	Inlet	72	80	91	100	99	98	99	94	106
HMF 100 T4/T6 10/3,3kW (A3:8) F400 (920 RPM - 24°)	Inlet	62	70	80	88	88	87	88	83	94
HMF 100 T4/T6 10/3,3kW (A3:8) F400 (1420 RPM - 28°)	Inlet	72	79	87	93	96	95	96	91	102
HMF 100 T4/T6 10/3,3kW (A3:8) F400 (1420 RPM - 26°)	Inlet	72	79	88	95	96	96	97	92	103
HMF 100 T4/T6 10/3,3kW (A3:8) F400 (1420 RPM - 20°)	Inlet	72	81	92	102	100	99	100	95	107
HMF 100 T4/T6 10/3,3kW (A3:8) F400 (920 RPM - 26°)	Inlet	62	70	79	86	87	87	87	82	93
HMF 100 T4/T6 10/3,3kW (A3:8) F400 (920 RPM - 22°)	Inlet	63	71	82	90	90	89	90	85	96
HMF 100 T4/T6 10/3,3kW (A3:8) F400 (920 RPM - 20°)	Inlet	63	71	83	92	90	89	90	86	97
HMF 100 T4/T6 10/3,3kW (A3:8) F400 (920 RPM - 28°)	Inlet	62	70	78	84	86	86	87	81	92
HMF 100 T4/T6 14/4,5kW (A3:4) F400 (920 RPM - 40°)	Inlet	59	66	72	78	81	81	83	77	88
HMF 100 T4/T6 14/4,5kW (A3:4) F400 (1420 RPM - 40°)	Inlet	68	75	81	87	90	91	92	86	97
HMF 100 T4/T6 14/4,5kW (A3:4) F400 (1420 RPM - 38°)	Inlet	68	74	81	86	89	90	92	85	96
HMF 100 T4/T6 14/4,5kW (A3:4) F400 (920 RPM - 38°)	Inlet	59	65	72	77	80	81	82	76	87
HMF 100 T4/T6 14/4,5kW (A3:8) F400 (1420 RPM - 28°)	Inlet	72	79	87	93	96	95	96	91	102
HMF 100 T4/T6 14/4,5kW (A3:8) F400 (1420 RPM - 32°)	Inlet	71	79	84	90	93	94	95	89	100
HMF 100 T4/T6 14/4,5kW (A3:8) F400 (1420 RPM - 30°)	Inlet	72	79	86	91	95	95	96	90	101
HMF 100 T4/T6 14/4,5kW (A3:8) F400 (920 RPM - 32°)	Inlet	62	69	75	80	84	85	85	79	90
HMF 100 T4/T6 14/4,5kW (A3:8) F400 (920 RPM - 30°)	Inlet	62	70	77	82	85	86	86	80	91
HMF 100 T4/T6 14/4,5kW (A3:8) F400 (920 RPM - 28°)	Inlet	62	70	78	84	86	86	87	81	92
HMF 100 T4/T6 16/6,5kW (A3:8) F400 (1420 RPM - 34°)	Inlet	71	78	83	88	92	93	94	88	99
HMF 100 T4/T6 16/6,5kW (A3:8) F400 (920 RPM - 34°)	Inlet	61	68	73	79	83	84	85	78	90

Sound power Lw dB (A)										
Model		63 Hz	125 Hz	250 Hz	500 Hz	1000 Hz	2000 Hz	4000 Hz	8000 Hz	Total
HMF 100 T4/T6 20/8,5kW (A3:8) F400 (1420 RPM - 38°)	Inlet	71	78	83	88	92	94	94	88	99
HMF 100 T4/T6 20/8,5kW (A3:8) F400 (1420 RPM - 36°)	Inlet	70	77	82	87	91	93	94	87	99
HMF 100 T4/T6 20/8,5kW (A3:8) F400 (920 RPM - 38°)	Inlet	62	69	74	79	83	84	85	79	90
HMF 100 T4/T6 20/8,5kW (A3:8) F400 (920 RPM - 36°)	Inlet	61	68	73	78	82	84	85	78	89
HMF 100 T4/T6 20/8,5kW (A3:8) F400 (1420 RPM - 40°)	Inlet	71	79	84	89	92	94	95	89	100
HMF 100 T4/T6 20/8,5kW (A3:8) F400 (920 RPM - 40°)	Inlet	62	69	74	79	83	85	85	79	90
HMF 112 T4/T6 6/2,2kW (A3:4) F400 (1420 RPM - 22°)	Inlet	68	79	84	90	94	95	96	92	102
HMF 112 T4/T6 6/2,2kW (A3:4) F400 (920 RPM - 22°)	Inlet	58	69	74	81	85	86	87	83	92
HMF 112 T4/T6 6/2,2kW (A3:4) F400 (920 RPM - 20°)	Inlet	56	68	73	81	84	85	87	83	91
HMF 112 T4/T6 6/2,2kW (A3:4) F400 (1420 RPM - 20°)	Inlet	66	78	83	90	94	94	96	92	101
HMF 112 T4/T6 10/3,3kW (A3:4) F400 (1420 RPM - 30°)	Inlet	71	78	83	88	92	93	94	88	99
HMF 112 T4/T6 10/3,3kW (A3:4) F400 (920 RPM - 28°)	Inlet	61	69	74	79	83	84	85	80	90
HMF 112 T4/T6 10/3,3kW (A3:4) F400 (920 RPM - 24°)	Inlet	59	69	74	80	84	85	86	82	91
HMF 112 T4/T6 10/3,3kW (A3:4) F400 (1420 RPM - 28°)	Inlet	71	78	83	89	92	93	95	89	99
HMF 112 T4/T6 10/3,3kW (A3:4) F400 (1420 RPM - 26°)	Inlet	70	78	83	89	93	94	95	90	100
HMF 112 T4/T6 10/3,3kW (A3:4) F400 (1420 RPM - 24°)	Inlet	69	78	83	90	93	94	96	91	101
HMF 112 T4/T6 10/3,3kW (A3:4) F400 (920 RPM - 30°)	Inlet	61	68	73	79	82	83	85	78	89
HMF 112 T4/T6 10/3,3kW (A3:4) F400 (920 RPM - 26°)	Inlet	60	69	74	80	84	84	86	81	90
HMF 112 T4/T6 14/4,5kW (A3:4) F400 (1420 RPM - 34°)	Inlet	70	76	82	87	90	92	93	86	98
HMF 112 T4/T6 14/4,5kW (A3:4) F400 (1420 RPM - 32°)	Inlet	70	77	82	87	91	92	94	87	98
HMF 112 T4/T6 14/4,5kW (A3:4) F400 (920 RPM - 36°)	Inlet	61	67	73	78	81	82	84	77	88
HMF 112 T4/T6 14/4,5kW (A3:4) F400 (1420 RPM - 36°)	Inlet	71	76	83	87	90	92	93	86	98
HMF 112 T4/T6 14/4,5kW (A3:4) F400 (920 RPM - 34°)	Inlet	61	67	73	78	81	82	84	77	88

Sound power Lw dB (A)										
Model		63 Hz	125 Hz	250 Hz	500 Hz	1000 Hz	2000 Hz	4000 Hz	8000 Hz	Total
HMF 112 T4/T6 14/4,5kW (A3:4) F400 (920 RPM - 32°)	Inlet	61	67	73	78	82	83	84	78	89
HMF 112 T4/T6 14/4,5kW (A3:8) F400 (1420 RPM - 26°)	Inlet	74	81	89	96	98	100	100	94	106
HMF 112 T4/T6 14/4,5kW (A3:8) F400 (1420 RPM - 24°)	Inlet	73	81	90	97	99	101	101	95	106
HMF 112 T4/T6 14/4,5kW (A3:8) F400 (1420 RPM - 22°)	Inlet	73	81	91	99	100	102	102	96	107
HMF 112 T4/T6 14/4,5kW (A3:8) F400 (920 RPM - 22°)	Inlet	64	72	81	90	90	92	92	87	97
HMF 112 T4/T6 14/4,5kW (A3:8) F400 (920 RPM - 20°)	Inlet	64	73	82	91	91	93	93	88	99
HMF 112 T4/T6 14/4,5kW (A3:8) F400 (1420 RPM - 20°)	Inlet	73	82	92	101	101	103	103	97	109
HMF 112 T4/T6 14/4,5kW (A3:8) F400 (920 RPM - 26°)	Inlet	64	71	80	86	89	90	90	85	96
HMF 112 T4/T6 14/4,5kW (A3:8) F400 (920 RPM - 24°)	Inlet	64	72	80	88	90	91	91	86	96
HMF 112 T4/T6 16/6,5kW (A3:4) F400 (1420 RPM - 38°)	Inlet	71	77	83	88	91	92	93	87	98
HMF 112 T4/T6 16/6,5kW (A3:4) F400 (920 RPM - 38°)	Inlet	62	68	74	78	81	83	84	77	89
HMF 112 T4/T6 16/6,5kW (A3:8) F400 (1420 RPM - 30°)	Inlet	74	80	87	93	97	99	99	93	104
HMF 112 T4/T6 16/6,5kW (A3:8) F400 (920 RPM - 30°)	Inlet	65	71	78	84	88	89	89	84	94
HMF 112 T4/T6 16/6,5kW (A3:8) F400 (1420 RPM - 28°)	Inlet	74	81	88	94	98	99	99	94	105
HMF 112 T4/T6 16/6,5kW (A3:8) F400 (920 RPM - 28°)	Inlet	65	71	79	85	89	90	90	84	95
HMF 112 T4/T6 20/8,5kW (A3:4) F400 (1420 RPM - 40°)	Inlet	72	79	84	89	91	93	94	87	99
HMF 112 T4/T6 20/8,5kW (A3:4) F400 (920 RPM - 40°)	Inlet	63	69	75	79	82	84	84	78	89
HMF 112 T4/T6 20/8,5kW (A3:8) F400 (1420 RPM - 32°)	Inlet	74	81	86	91	96	97	97	91	103
HMF 112 T4/T6 20/8,5kW (A3:8) F400 (920 RPM - 32°)	Inlet	64	71	77	82	86	88	88	82	93
HMF 112 T4/T6 26/9kW (A3:8) F400 (1420 RPM - 34°)	Inlet	73	80	85	90	94	96	96	89	101
HMF 112 T4/T6 26/9kW (A3:8) F400 (920 RPM - 36°)	Inlet	63	70	75	80	84	86	86	79	91
HMF 112 T4/T6 26/9kW (A3:8) F400 (920 RPM - 34°)	Inlet	64	71	76	81	84	86	87	80	91
HMF 112 T4/T6 26/9kW (A3:8) F400 (1420 RPM - 38°)	Inlet	73	80	85	90	94	96	95	89	101

		Sound power Lw dB (A)								
Model		63 Hz	125 Hz	250 Hz	500 Hz	1000 Hz	2000 Hz	4000 Hz	8000 Hz	Total
HMF 112 T4/T6 26/9kW (A3:8) F400 (1420 RPM - 36°)	Inlet	73	80	85	90	93	95	95	89	101
HMF 112 T4/T6 26/9kW (A3:8) F400 (920 RPM - 38°)	Inlet	64	71	76	81	84	86	86	80	91
HMF 112 T4/T6 34/12kW (A3:8) F400 (920 RPM - 40°)	Inlet	64	71	76	81	85	87	86	80	91
HMF 112 T4/T6 34/12kW (A3:8) F400 (1420 RPM - 40°)	Inlet	74	81	86	90	94	96	95	90	101
HMF 125 T4/T6 10/3,3kW (A3:4) F400 (1420 RPM - 22°)	Inlet	75	86	91	98	102	103	105	101	109
HMF 125 T4/T6 10/3,3kW (A3:4) F400 (920 RPM - 20°)	Inlet	63	76	81	89	92	92	94	91	99
HMF 125 T4/T6 10/3,3kW (A3:4) F400 (1420 RPM - 20°)	Inlet	72	85	90	98	102	102	104	101	109
HMF 125 T4/T6 10/3,3kW (A3:4) F400 (920 RPM - 22°)	Inlet	65	77	82	89	92	93	95	91	99
HMF 125 T4/T6 14/4,5kW (A3:4) F400 (1420 RPM - 26°)	Inlet	76	84	89	94	98	99	101	95	106
HMF 125 T4/T6 14/4,5kW (A3:4) F400 (1420 RPM - 24°)	Inlet	75	85	90	96	100	101	103	98	107
HMF 125 T4/T6 14/4,5kW (A3:4) F400 (920 RPM - 24°)	Inlet	66	76	81	87	90	91	93	89	97
HMF 125 T4/T6 14/4,5kW (A3:4) F400 (920 RPM - 26°)	Inlet	66	74	79	85	89	90	91	86	96
HMF 125 T4/T6 16/6,5kW (A3:4) F400 (1420 RPM - 28°)	Inlet	75	82	87	93	96	98	99	93	104
HMF 125 T4/T6 16/6,5kW (A3:4) F400 (920 RPM - 30°)	Inlet	65	72	77	82	85	87	88	82	92
HMF 125 T4/T6 16/6,5kW (A3:4) F400 (920 RPM - 28°)	Inlet	66	73	78	83	87	88	89	84	94
HMF 125 T4/T6 16/6,5kW (A3:4) F400 (1420 RPM - 30°)	Inlet	74	81	86	91	95	96	97	91	102
HMF 125 T4/T6 20/8,5kW (A3:4) F400 (1420 RPM - 34°)	Inlet	73	80	85	90	93	95	96	88	101
HMF 125 T4/T6 20/8,5kW (A3:4) F400 (1420 RPM - 32°)	Inlet	74	81	86	90	94	96	96	90	102
HMF 125 T4/T6 20/8,5kW (A3:4) F400 (920 RPM - 32°)	Inlet	65	72	77	81	85	86	87	80	92
HMF 125 T4/T6 20/8,5kW (A3:4) F400 (920 RPM - 34°)	Inlet	64	71	76	81	84	85	87	79	91
HMF 125 T4/T6 20/8,5kW (A3:8) F400 (1420 RPM - 24°)	Inlet	78	85	92	100	106	108	108	102	113
HMF 125 T4/T6 20/8,5kW (A3:8) F400 (1420 RPM - 22°)	Inlet	79	86	93	102	107	110	109	104	114
HMF 125 T4/T6 20/8,5kW (A3:8) F400 (920 RPM - 24°)	Inlet	69	76	83	90	96	98	98	92	103

		Sound power Lw dB (A)								
Model		63 Hz	125 Hz	250 Hz	500 Hz	1000 Hz	2000 Hz	4000 Hz	8000 Hz	Total
HMF 125 T4/T6 20/8,5kW (A3:8) F400 (920 RPM - 22°)	Inlet	69	77	84	92	97	100	99	94	104
HMF 125 T4/T6 20/8,5kW (A3:8) F400 (920 RPM - 20°)	Inlet	69	77	84	93	98	101	100	95	105
HMF 125 T4/T6 20/8,5kW (A3:8) F400 (1420 RPM - 20°)	Inlet	78	86	93	103	108	111	110	105	115
HMF 125 T4/T6 26/9kW (A3:4) F400 (1420 RPM - 38°)	Inlet	74	81	86	91	93	95	96	89	101
HMF 125 T4/T6 26/9kW (A3:4) F400 (1420 RPM - 36°)	Inlet	74	81	86	90	93	95	96	88	101
HMF 125 T4/T6 26/9kW (A3:4) F400 (920 RPM - 36°)	Inlet	64	71	76	81	84	85	86	79	91
HMF 125 T4/T6 26/9kW (A3:4) F400 (920 RPM - 38°)	Inlet	65	72	77	81	84	86	87	79	91
HMF 125 T4/T6 26/9kW (A3:8) F400 (1420 RPM - 30°)	Inlet	77	83	90	96	101	103	104	97	108
HMF 125 T4/T6 26/9kW (A3:8) F400 (1420 RPM - 28°)	Inlet	78	84	91	97	102	105	105	98	110
HMF 125 T4/T6 26/9kW (A3:8) F400 (920 RPM - 28°)	Inlet	68	75	81	88	92	95	95	89	100
HMF 125 T4/T6 26/9kW (A3:8) F400 (1420 RPM - 26°)	Inlet	78	85	91	98	104	106	106	100	111
HMF 125 T4/T6 26/9kW (A3:8) F400 (920 RPM - 30°)	Inlet	68	74	80	86	91	93	94	87	98
HMF 125 T4/T6 26/9kW (A3:8) F400 (920 RPM - 26°)	Inlet	69	75	82	89	94	96	96	90	101
HMF 125 T4/T6 34/12kW (A3:4) F400 (1420 RPM - 40°)	Inlet	75	82	87	91	93	96	96	89	102
HMF 125 T4/T6 34/12kW (A3:4) F400 (920 RPM - 40°)	Inlet	65	72	77	82	84	87	87	80	92
HMF 125 T4/T6 34/12kW (A3:8) F400 (920 RPM - 34°)	Inlet	68	74	80	85	88	90	90	83	95
HMF 125 T4/T6 34/12kW (A3:8) F400 (1420 RPM - 34°)	Inlet	77	83	89	94	97	99	100	92	105
HMF 125 T4/T6 34/12kW (A3:8) F400 (1420 RPM - 32°)	Inlet	77	83	89	95	99	102	102	94	107
HMF 125 T4/T6 34/12kW (A3:8) F400 (920 RPM - 32°)	Inlet	68	74	80	85	90	92	92	85	97
HMF 125 T4/T6 40/14kW (A3:8) F400 (920 RPM - 36°)	Inlet	67	74	79	84	87	89	89	82	94
HMF 125 T4/T6 40/14kW (A3:8) F400 (1420 RPM - 38°)	Inlet	76	83	88	93	96	98	97	91	104
HMF 125 T4/T6 40/14kW (A3:8) F400 (1420 RPM - 36°)	Inlet	77	83	89	93	96	98	98	91	104
HMF 125 T4/T6 40/14kW (A3:8) F400 (920 RPM - 38°)	Inlet	67	74	79	84	87	89	88	81	94

Sound / 4/8 poles

		Sound power Lw dB (A)								
Model		63 Hz	125 Hz	250 Hz	500 Hz	1000 Hz	2000 Hz	4000 Hz	8000 Hz	Total
HMF 45 T4/T8 0,8/0,2kW (A5:6) F400 (1500 RPM - 40°)	Inlet	50	57	62	67	70	70	71	64	76
HMF 45 T4/T8 0,8/0,2kW (A5:6) F400 (750 RPM - 40°)	Inlet	35	42	47	52	55	55	56	49	61
HMF 50 T4/T8 0,8/0,2kW (A5:6) F400 (750 RPM - 40°)	Inlet	38	45	50	54	57	56	57	51	63
HMF 50 T4/T8 0,8/0,2kW (A5:6) F400 (1500 RPM - 40°)	Inlet	53	60	65	69	72	71	72	66	78
HMF 56 T4/T8 0,8/0,2kW (A5:6) F400 (750 RPM - 32.5°)	Inlet	39	46	51	60	60	61	64	55	68
HMF 56 T4/T8 0,8/0,2kW (A5:6) F400 (750 RPM - 25°)	Inlet	39	47	52	60	64	61	63	55	69
HMF 56 T4/T8 0,8/0,2kW (A5:6) F400 (750 RPM - 30°)	Inlet	41	48	53	62	63	62	65	57	69
HMF 56 T4/T8 0,8/0,2kW (A5:6) F400 (1500 RPM - 25°)	Inlet	54	62	67	75	79	76	78	70	84
HMF 56 T4/T8 0,8/0,2kW (A5:6) F400 (1500 RPM - 32.5°)	Inlet	54	61	66	75	75	76	79	70	83
HMF 56 T4/T8 0,8/0,2kW (A5:6) F400 (1500 RPM - 30°)	Inlet	56	63	68	77	78	78	80	72	85
HMF 56 T4/T8 1,2/0,3kW (A5:6) F400 (750 RPM - 37.5°)	Inlet	39	46	51	59	59	60	63	54	67
HMF 56 T4/T8 1,2/0,3kW (A5:6) F400 (750 RPM - 35°)	Inlet	38	45	50	58	58	60	62	54	66
HMF 56 T4/T8 1,2/0,3kW (A5:6) F400 (1500 RPM - 37.5°)	Inlet	54	61	66	75	74	76	78	69	82
HMF 56 T4/T8 1,2/0,3kW (A5:6) F400 (1500 RPM - 35°)	Inlet	53	60	65	74	73	75	78	69	82
HMF 56 T4/T8 1,6/0,4kW (A5:6) F400 (750 RPM - 40°)	Inlet	41	48	53	60	60	61	63	55	68
HMF 56 T4/T8 1,6/0,4kW (A5:6) F400 (750 RPM - 42.5°)	Inlet	43	50	55	61	61	62	64	55	69
HMF 56 T4/T8 1,6/0,4kW (A5:6) F400 (1500 RPM - 40°)	Inlet	56	63	68	76	75	76	79	70	83
HMF 56 T4/T8 1,6/0,4kW (A5:6) F400 (1500 RPM - 42.5°)	Inlet	58	65	70	76	76	77	79	70	84
HMF 63 T4/T8 0,8/0,2kW (A5:6) F400 (750 RPM - 25°)	Inlet	42	51	56	65	65	64	65	60	71
HMF 63 T4/T8 0,8/0,2kW (A5:6) F400 (1500 RPM - 25°)	Inlet	57	66	71	80	80	79	80	75	86
HMF 63 T4/T8 1,2/0,3kW (A5:6) F400 (750 RPM - 30°)	Inlet	45	53	59	65	65	64	67	62	72
HMF 63 T4/T8 1,2/0,3kW (A5:6) F400 (1500 RPM - 30°)	Inlet	60	68	74	80	80	79	82	77	87

Sound power Lw dB (A)										
Model		63 Hz	125 Hz	250 Hz	500 Hz	1000 Hz	2000 Hz	4000 Hz	8000 Hz	Total
HMF 63 T4/T8 1,6/0,4kW (A5:6) F400 (750 RPM - 35°)	Inlet	43	52	57	60	61	60	64	58	68
HMF 63 T4/T8 1,6/0,4kW (A5:6) F400 (1500 RPM - 35°)	Inlet	59	67	72	75	76	76	79	73	83
HMF 63 T4/T8 1,6/0,4kW (A5:6) F400 (750 RPM - 32.5°)	Inlet	44	52	58	62	63	62	65	60	70
HMF 63 T4/T8 1,6/0,4kW (A5:6) F400 (1500 RPM - 32.5°)	Inlet	59	68	73	77	78	77	80	75	85
HMF 63 T4/T8 2,2/0,37kW (A5:6) F400 (750 RPM - 37.5°)	Inlet	44	52	57	61	62	62	64	58	69
HMF 63 T4/T8 2,2/0,37kW (A5:6) F400 (750 RPM - 40°)	Inlet	45	52	57	62	62	63	65	58	70
HMF 63 T4/T8 2,2/0,37kW (A5:6) F400 (1500 RPM - 40°)	Inlet	60	67	72	77	78	78	80	73	85
HMF 63 T4/T8 2,2/0,37kW (A5:6) F400 (1500 RPM - 37.5°)	Inlet	59	67	72	76	77	77	79	73	84
HMF 71 T4/T8 0,8/0,2kW (A5:6) F400 (750 RPM - 20°)	Inlet	40	51	56	71	70	67	69	61	76
HMF 71 T4/T8 0,8/0,2kW (A5:6) F400 (1500 RPM - 20°)	Inlet	55	66	71	86	85	82	84	76	91
HMF 71 T4/T8 1,2/0,3kW (A5:6) F400 (750 RPM - 25°)	Inlet	44	51	56	69	68	67	69	60	75
HMF 71 T4/T8 1,2/0,3kW (A5:6) F400 (1500 RPM - 25°)	Inlet	59	67	72	84	84	82	84	75	90
HMF 71 T4/T8 1,6/0,4kW (A5:6) F400 (750 RPM - 30°)	Inlet	46	53	58	67	67	68	69	58	74
HMF 71 T4/T8 1,6/0,4kW (A5:6) F400 (1500 RPM - 30°)	Inlet	61	68	73	82	82	83	84	73	89
HMF 71 T4/T8 2,2/0,37kW (A5:6) F400 (750 RPM - 35°)	Inlet	47	54	59	61	65	67	68	57	72
HMF 71 T4/T8 2,2/0,37kW (A5:6) F400 (750 RPM - 32.5°)	Inlet	46	53	58	64	66	68	68	58	73
HMF 71 T4/T8 2,2/0,37kW (A5:6) F400 (1500 RPM - 35°)	Inlet	62	69	74	76	80	82	83	72	87
HMF 71 T4/T8 2,2/0,37kW (A5:6) F400 (1500 RPM - 32.5°)	Inlet	62	69	74	79	81	83	84	73	88
HMF 71 T4/T8 3/0,55kW (A5:6) F400 (750 RPM - 40°)	Inlet	52	58	64	66	69	70	71	61	76
HMF 71 T4/T8 3/0,55kW (A5:6) F400 (750 RPM - 37.5°)	Inlet	50	56	62	64	67	69	70	59	74
HMF 71 T4/T8 3/0,55kW (A5:6) F400 (1500 RPM - 40°)	Inlet	67	73	79	81	84	85	86	76	91
HMF 71 T4/T8 3/0,55kW (A5:6) F400 (1500 RPM - 37.5°)	Inlet	65	71	77	79	82	84	85	74	89
HMF 80 T4/T8 3/0,55kW (A5:6) F400 (750 RPM - 35°)	Inlet	47	54	59	64	67	67	71	61	74

Sound power Lw dB (A)										
Model		63 Hz	125 Hz	250 Hz	500 Hz	1000 Hz	2000 Hz	4000 Hz	8000 Hz	Total
HMf 80 T4/T8 3/0,55kW (A5:6) F400 (1500 RPM - 35°)	Inlet	62	69	74	79	82	82	86	76	89
HMf 80 T4/T8 3/0,55kW (A5:6) F400 (750 RPM - 32.5°)	Inlet	48	55	60	66	69	69	73	64	76
HMf 80 T4/T8 3/0,55kW (A5:6) F400 (1500 RPM - 32.5°)	Inlet	63	70	75	81	85	84	88	80	91
HMf 80 T4/T8 3/0,55kW (A5:6) F400 (1500 RPM - 30°)	Inlet	64	71	76	83	87	86	90	83	94
HMf 80 T4/T8 3/0,55kW (A5:6) F400 (750 RPM - 30°)	Inlet	49	56	61	68	72	71	74	68	79
HMf 80 T4/T8 4/0,75kW (A5:6) F400 (750 RPM - 37.5°)	Inlet	49	56	61	65	68	68	71	61	75
HMf 80 T4/T8 4/0,75kW (A5:6) F400 (1500 RPM - 37.5°)	Inlet	64	71	76	80	83	83	86	76	90
HMf 80 T4/T8 4/0,75kW (A5:6) F400 (750 RPM - 40°)	Inlet	51	58	63	67	69	69	70	61	76
HMf 80 T4/T8 4/0,75kW (A5:6) F400 (1500 RPM - 40°)	Inlet	66	73	78	82	84	84	86	76	91
HMf 90 T4/T8 2,8/0,7kW (A3:4) F400 (1420 RPM - 22°)	Inlet	61	69	74	83	87	87	86	77	92
HMf 90 T4/T8 2,8/0,7kW (A3:4) F400 (1420 RPM - 20°)	Inlet	57	68	73	84	88	88	86	78	93
HMf 90 T4/T8 2,8/0,7kW (A3:4) F400 (720 RPM - 22°)	Inlet	45	53	58	67	71	71	70	62	76
HMf 90 T4/T8 2,8/0,7kW (A3:4) F400 (720 RPM - 20°)	Inlet	41	52	57	68	72	72	70	62	77
HMf 90 T4/T8 4/0,75kW (A3:4) F400 (1420 RPM - 26°)	Inlet	64	71	76	83	85	85	84	76	91
HMf 90 T4/T8 4/0,75kW (A3:4) F400 (1420 RPM - 24°)	Inlet	63	70	75	83	86	86	85	77	91
HMf 90 T4/T8 4/0,75kW (A3:4) F400 (720 RPM - 26°)	Inlet	48	55	60	67	69	69	68	60	75
HMf 90 T4/T8 4/0,75kW (A3:4) F400 (720 RPM - 24°)	Inlet	47	54	59	67	70	70	69	61	75
HMf 90 T4/T8 5,5/1,1kW (A3:4) F400 (1420 RPM - 30°)	Inlet	66	73	78	83	83	83	83	75	89
HMf 90 T4/T8 5,5/1,1kW (A3:4) F400 (1420 RPM - 28°)	Inlet	65	72	77	83	84	84	84	76	90
HMf 90 T4/T8 5,5/1,1kW (A3:4) F400 (1420 RPM - 32°)	Inlet	66	73	78	82	83	83	83	75	89
HMf 90 T4/T8 5,5/1,1kW (A3:4) F400 (720 RPM - 32°)	Inlet	50	57	62	66	67	67	67	59	73
HMf 90 T4/T8 5,5/1,1kW (A3:4) F400 (720 RPM - 30°)	Inlet	51	58	63	67	67	67	67	59	74
HMf 90 T4/T8 5,5/1,1kW (A3:4) F400 (720 RPM - 28°)	Inlet	49	56	61	67	68	68	68	60	74

		Sound power Lw dB (A)								
Model		63 Hz	125 Hz	250 Hz	500 Hz	1000 Hz	2000 Hz	4000 Hz	8000 Hz	Total
HMF 90 T4/T8 5,5/1,1kW (A3:8) F400 (1420 RPM - 22°)	Inlet	69	80	88	90	92	87	88	78	97
HMF 90 T4/T8 5,5/1,1kW (A3:8) F400 (1420 RPM - 20°)	Inlet	69	81	90	91	93	87	88	78	98
HMF 90 T4/T8 5,5/1,1kW (A3:8) F400 (720 RPM - 22°)	Inlet	53	64	72	74	76	72	72	62	81
HMF 90 T4/T8 5,5/1,1kW (A3:8) F400 (720 RPM - 20°)	Inlet	53	65	74	75	77	71	72	62	82
HMF 90 T4/T8 7,5/1,5kW (A3:4) F400 (1420 RPM - 34°)	Inlet	65	72	77	81	83	84	82	74	89
HMF 90 T4/T8 7,5/1,5kW (A3:4) F400 (1420 RPM - 38°)	Inlet	67	74	79	82	85	84	83	76	91
HMF 90 T4/T8 7,5/1,5kW (A3:4) F400 (1420 RPM - 36°)	Inlet	66	73	78	81	84	84	82	74	90
HMF 90 T4/T8 7,5/1,5kW (A3:4) F400 (1420 RPM - 32°)	Inlet	66	73	78	82	83	83	83	75	89
HMF 90 T4/T8 7,5/1,5kW (A3:4) F400 (720 RPM - 38°)	Inlet	51	58	63	66	69	69	67	60	75
HMF 90 T4/T8 7,5/1,5kW (A3:4) F400 (720 RPM - 36°)	Inlet	50	57	62	66	68	68	67	58	74
HMF 90 T4/T8 7,5/1,5kW (A3:4) F400 (720 RPM - 34°)	Inlet	50	57	62	66	67	68	66	58	73
HMF 90 T4/T8 7,5/1,5kW (A3:4) F400 (720 RPM - 32°)	Inlet	50	57	62	66	67	67	67	59	73
HMF 90 T4/T8 7,5/1,5kW (A3:8) F400 (1420 RPM - 28°)	Inlet	70	76	82	87	89	88	87	79	94
HMF 90 T4/T8 7,5/1,5kW (A3:8) F400 (1420 RPM - 26°)	Inlet	70	78	84	88	90	88	88	79	95
HMF 90 T4/T8 7,5/1,5kW (A3:8) F400 (1420 RPM - 24°)	Inlet	69	79	86	89	91	88	88	78	96
HMF 90 T4/T8 7,5/1,5kW (A3:8) F400 (720 RPM - 28°)	Inlet	54	60	66	71	73	72	71	63	79
HMF 90 T4/T8 7,5/1,5kW (A3:8) F400 (720 RPM - 26°)	Inlet	54	62	68	72	74	72	72	63	79
HMF 90 T4/T8 7,5/1,5kW (A3:8) F400 (720 RPM - 24°)	Inlet	54	63	70	73	75	72	72	63	80
HMF 90 T4/T8 11/3kW (A3:4) F400 (1420 RPM - 40°)	Inlet	68	75	80	83	87	85	84	77	91
HMF 90 T4/T8 11/3kW (A3:4) F400 (720 RPM - 40°)	Inlet	52	59	64	67	71	69	68	61	75
HMF 90 T4/T8 11/3kW (A3:8) F400 (1420 RPM - 36°)	Inlet	67	74	79	83	87	87	85	77	92
HMF 90 T4/T8 11/3kW (A3:8) F400 (1420 RPM - 34°)	Inlet	67	74	79	84	87	87	85	77	92
HMF 90 T4/T8 11/3kW (A3:8) F400 (1420 RPM - 32°)	Inlet	67	74	79	85	87	87	86	78	93

		Sound power Lw dB (A)								
Model		63 Hz	125 Hz	250 Hz	500 Hz	1000 Hz	2000 Hz	4000 Hz	8000 Hz	Total
HMF 90 T4/T8 11/3kW (A3:8) F400 (1420 RPM - 30°)	Inlet	68	75	80	86	88	88	87	79	94
HMF 90 T4/T8 11/3kW (A3:8) F400 (720 RPM - 36°)	Inlet	51	58	63	67	71	71	69	61	76
HMF 90 T4/T8 11/3kW (A3:8) F400 (720 RPM - 34°)	Inlet	51	58	63	68	71	71	69	61	76
HMF 90 T4/T8 11/3kW (A3:8) F400 (720 RPM - 32°)	Inlet	52	59	64	69	71	72	70	62	77
HMF 90 T4/T8 11/3kW (A3:8) F400 (720 RPM - 30°)	Inlet	52	59	64	70	72	72	71	63	78
HMF 90 T4/T8 14/3,5kW (A3:8) F400 (1420 RPM - 40°)	Inlet	71	78	83	84	88	87	84	78	93
HMF 90 T4/T8 14/3,5kW (A3:8) F400 (1420 RPM - 38°)	Inlet	69	76	81	84	87	87	84	77	92
HMF 90 T4/T8 14/3,5kW (A3:8) F400 (720 RPM - 40°)	Inlet	55	62	67	68	72	71	68	62	77
HMF 90 T4/T8 14/3,5kW (A3:8) F400 (720 RPM - 38°)	Inlet	53	60	65	68	71	71	69	61	77
HMF 100 T4/T8 5,5/1,1kW (A3:4) F400 (1420 RPM - 26°)	Inlet	67	75	81	87	90	91	93	88	97
HMF 100 T4/T8 5,5/1,1kW (A3:4) F400 (1420 RPM - 24°)	Inlet	67	76	81	87	91	92	93	89	98
HMF 100 T4/T8 5,5/1,1kW (A3:4) F400 (1420 RPM - 22°)	Inlet	66	76	82	88	91	92	93	90	98
HMF 100 T4/T8 5,5/1,1kW (A3:4) F400 (1420 RPM - 20°)	Inlet	66	76	81	88	91	92	93	90	98
HMF 100 T4/T8 5,5/1,1kW (A3:4) F400 (720 RPM - 26°)	Inlet	51	59	65	71	74	75	77	72	82
HMF 100 T4/T8 5,5/1,1kW (A3:4) F400 (720 RPM - 24°)	Inlet	51	60	66	72	75	76	77	73	82
HMF 100 T4/T8 5,5/1,1kW (A3:4) F400 (720 RPM - 22°)	Inlet	50	60	66	72	76	76	77	74	82
HMF 100 T4/T8 5,5/1,1kW (A3:4) F400 (720 RPM - 20°)	Inlet	50	60	66	72	76	76	77	74	82
HMF 100 T4/T8 7,5/1,5kW (A3:4) F400 (1420 RPM - 30°)	Inlet	68	74	81	86	90	91	93	86	97
HMF 100 T4/T8 7,5/1,5kW (A3:4) F400 (1420 RPM - 28°)	Inlet	67	75	81	86	90	91	93	87	97
HMF 100 T4/T8 7,5/1,5kW (A3:4) F400 (720 RPM - 30°)	Inlet	52	59	65	70	74	75	77	70	81
HMF 100 T4/T8 7,5/1,5kW (A3:4) F400 (720 RPM - 28°)	Inlet	51	59	65	71	74	75	77	71	81
HMF 100 T4/T8 7,5/1,5kW (A3:8) F400 (1420 RPM - 20°)	Inlet	72	81	92	102	100	99	100	95	107
HMF 100 T4/T8 7,5/1,5kW (A3:8) F400 (720 RPM - 20°)	Inlet	56	65	76	86	84	83	84	79	91

		Sound power Lw dB (A)								
Model		63 Hz	125 Hz	250 Hz	500 Hz	1000 Hz	2000 Hz	4000 Hz	8000 Hz	Total
HMF 100 T4/T8 11/3kW (A3:4) F400 (1420 RPM - 38°)	Inlet	68	74	81	86	89	90	92	85	96
HMF 100 T4/T8 11/3kW (A3:4) F400 (1420 RPM - 36°)	Inlet	69	73	81	86	88	90	91	85	96
HMF 100 T4/T8 11/3kW (A3:4) F400 (1420 RPM - 34°)	Inlet	69	73	81	85	88	90	91	85	96
HMF 100 T4/T8 11/3kW (A3:4) F400 (1420 RPM - 32°)	Inlet	68	74	81	86	89	90	92	86	96
HMF 100 T4/T8 11/3kW (A3:4) F400 (720 RPM - 38°)	Inlet	52	58	65	70	73	74	76	69	80
HMF 100 T4/T8 11/3kW (A3:4) F400 (720 RPM - 36°)	Inlet	53	57	65	70	72	74	75	69	80
HMF 100 T4/T8 11/3kW (A3:4) F400 (720 RPM - 34°)	Inlet	53	57	65	69	72	74	76	69	80
HMF 100 T4/T8 11/3kW (A3:4) F400 (720 RPM - 32°)	Inlet	52	58	65	70	73	74	76	70	80
HMF 100 T4/T8 11/3kW (A3:8) F400 (1420 RPM - 28°)	Inlet	72	79	87	93	96	95	96	91	102
HMF 100 T4/T8 11/3kW (A3:8) F400 (1420 RPM - 24°)	Inlet	72	79	89	97	97	97	98	93	104
HMF 100 T4/T8 11/3kW (A3:8) F400 (1420 RPM - 22°)	Inlet	72	80	91	100	99	98	99	94	106
HMF 100 T4/T8 11/3kW (A3:8) F400 (1420 RPM - 26°)	Inlet	72	79	88	95	96	96	97	92	103
HMF 100 T4/T8 11/3kW (A3:8) F400 (720 RPM - 28°)	Inlet	56	63	71	77	80	80	80	75	86
HMF 100 T4/T8 11/3kW (A3:8) F400 (720 RPM - 26°)	Inlet	56	63	72	79	80	80	81	76	87
HMF 100 T4/T8 11/3kW (A3:8) F400 (720 RPM - 24°)	Inlet	56	64	73	81	82	81	82	77	88
HMF 100 T4/T8 11/3kW (A3:8) F400 (720 RPM - 22°)	Inlet	56	64	75	84	83	82	83	78	90
HMF 100 T4/T8 14/3,5kW (A3:4) F400 (1420 RPM - 40°)	Inlet	68	75	81	87	90	91	92	86	97
HMF 100 T4/T8 14/3,5kW (A3:4) F400 (720 RPM - 40°)	Inlet	52	59	66	71	75	75	76	70	81
HMF 100 T4/T8 14/3,5kW (A3:8) F400 (1420 RPM - 32°)	Inlet	71	79	84	90	93	94	95	89	100
HMF 100 T4/T8 14/3,5kW (A3:8) F400 (1420 RPM - 30°)	Inlet	72	79	86	91	95	95	96	90	101
HMF 100 T4/T8 14/3,5kW (A3:8) F400 (720 RPM - 32°)	Inlet	55	63	68	74	77	78	79	73	84
HMF 100 T4/T8 14/3,5kW (A3:8) F400 (720 RPM - 30°)	Inlet	56	63	70	75	79	79	80	74	85
HMF 100 T4/T8 17/4,3kW (A3:8) F400 (1420 RPM - 36°)	Inlet	70	77	82	87	91	93	94	87	99

		Sound power Lw dB (A)								
Model		63 Hz	125 Hz	250 Hz	500 Hz	1000 Hz	2000 Hz	4000 Hz	8000 Hz	Total
HMF 100 T4/T8 17/4,3kW (A3:8) F400 (1420 RPM - 34°)	Inlet	71	78	83	88	92	93	94	88	99
HMF 100 T4/T8 17/4,3kW (A3:8) F400 (720 RPM - 36°)	Inlet	54	61	66	71	75	77	78	72	83
HMF 100 T4/T8 17/4,3kW (A3:8) F400 (720 RPM - 34°)	Inlet	55	62	67	72	76	77	78	72	83
HMF 100 T4/T8 20/5kW (A3:8) F400 (1420 RPM - 38°)	Inlet	71	78	83	88	92	94	94	88	99
HMF 100 T4/T8 20/5kW (A3:8) F400 (1420 RPM - 40°)	Inlet	71	79	84	89	92	94	95	89	100
HMF 100 T4/T8 20/5kW (A3:8) F400 (720 RPM - 40°)	Inlet	56	63	68	73	76	78	79	73	84
HMF 100 T4/T8 20/5kW (A3:8) F400 (720 RPM - 38°)	Inlet	55	62	67	72	76	78	78	72	83
HMF 112 T4/T8 5,5/1,1kW (A3:4) F400 (1420 RPM - 20°)	Inlet	66	78	83	90	94	94	96	92	101
HMF 112 T4/T8 5,5/1,1kW (A3:4) F400 (720 RPM - 20°)	Inlet	50	62	67	74	78	78	80	76	85
HMF 112 T4/T8 7,5/1,5kW (A3:4) F400 (1420 RPM - 22°)	Inlet	68	79	84	90	94	95	96	92	102
HMF 112 T4/T8 7,5/1,5kW (A3:4) F400 (1420 RPM - 24°)	Inlet	69	78	83	90	93	94	96	91	101
HMF 112 T4/T8 7,5/1,5kW (A3:4) F400 (720 RPM - 24°)	Inlet	53	62	67	74	77	78	80	75	85
HMF 112 T4/T8 7,5/1,5kW (A3:4) F400 (720 RPM - 22°)	Inlet	52	63	68	74	78	79	81	76	86
HMF 112 T4/T8 11/3kW (A3:4) F400 (1420 RPM - 32°)	Inlet	70	77	82	87	91	92	94	87	98
HMF 112 T4/T8 11/3kW (A3:4) F400 (1420 RPM - 30°)	Inlet	71	78	83	88	92	93	94	88	99
HMF 112 T4/T8 11/3kW (A3:4) F400 (1420 RPM - 28°)	Inlet	71	78	83	89	92	93	95	89	99
HMF 112 T4/T8 11/3kW (A3:4) F400 (1420 RPM - 26°)	Inlet	70	78	83	89	93	94	95	90	100
HMF 112 T4/T8 11/3kW (A3:4) F400 (720 RPM - 32°)	Inlet	55	61	67	72	75	76	78	71	82
HMF 112 T4/T8 11/3kW (A3:4) F400 (720 RPM - 30°)	Inlet	55	62	67	72	76	77	78	72	83
HMF 112 T4/T8 11/3kW (A3:4) F400 (720 RPM - 28°)	Inlet	55	62	67	73	76	77	79	73	83
HMF 112 T4/T8 11/3kW (A3:4) F400 (720 RPM - 26°)	Inlet	54	62	67	73	77	78	79	74	84
HMF 112 T4/T8 11/3kW (A3:8) F400 (1420 RPM - 20°)	Inlet	73	82	92	101	101	103	103	97	109
HMF 112 T4/T8 11/3kW (A3:8) F400 (720 RPM - 20°)	Inlet	57	66	76	85	85	87	87	81	93

		Sound power Lw dB (A)								
Model		63 Hz	125 Hz	250 Hz	500 Hz	1000 Hz	2000 Hz	4000 Hz	8000 Hz	Total
HMF 112 T4/T8 14/3,5kW (A3:4) F400 (1420 RPM - 34°)	Inlet	70	76	82	87	90	92	93	86	98
HMF 112 T4/T8 14/3,5kW (A3:4) F400 (1420 RPM - 36°)	Inlet	71	76	83	87	90	92	93	86	98
HMF 112 T4/T8 14/3,5kW (A3:4) F400 (720 RPM - 36°)	Inlet	55	60	67	71	74	76	77	70	82
HMF 112 T4/T8 14/3,5kW (A3:4) F400 (720 RPM - 34°)	Inlet	54	60	66	71	74	76	77	70	82
HMF 112 T4/T8 14/3,5kW (A3:8) F400 (1420 RPM - 26°)	Inlet	74	81	89	96	98	100	100	94	106
HMF 112 T4/T8 14/3,5kW (A3:8) F400 (1420 RPM - 24°)	Inlet	73	81	90	97	99	101	101	95	106
HMF 112 T4/T8 14/3,5kW (A3:8) F400 (1420 RPM - 22°)	Inlet	73	81	91	99	100	102	102	96	107
HMF 112 T4/T8 14/3,5kW (A3:8) F400 (720 RPM - 26°)	Inlet	58	65	73	80	83	84	84	78	90
HMF 112 T4/T8 14/3,5kW (A3:8) F400 (720 RPM - 24°)	Inlet	57	65	74	81	83	85	85	79	90
HMF 112 T4/T8 14/3,5kW (A3:8) F400 (720 RPM - 22°)	Inlet	57	65	75	83	84	86	86	80	91
HMF 112 T4/T8 17/4,3kW (A3:4) F400 (1420 RPM - 40°)	Inlet	72	79	84	89	91	93	94	87	99
HMF 112 T4/T8 17/4,3kW (A3:4) F400 (1420 RPM - 38°)	Inlet	71	77	83	88	91	92	93	87	98
HMF 112 T4/T8 17/4,3kW (A3:4) F400 (720 RPM - 40°)	Inlet	56	63	68	73	76	77	78	71	83
HMF 112 T4/T8 17/4,3kW (A3:4) F400 (720 RPM - 38°)	Inlet	55	61	67	72	75	76	78	71	82
HMF 112 T4/T8 17/4,3kW (A3:8) F400 (1420 RPM - 30°)	Inlet	74	80	87	93	97	99	99	93	104
HMF 112 T4/T8 17/4,3kW (A3:8) F400 (1420 RPM - 28°)	Inlet	74	81	88	94	98	99	99	94	105
HMF 112 T4/T8 17/4,3kW (A3:8) F400 (720 RPM - 30°)	Inlet	58	65	72	77	81	83	83	77	88
HMF 112 T4/T8 17/4,3kW (A3:8) F400 (720 RPM - 28°)	Inlet	58	65	72	78	82	83	83	78	89
HMF 112 T4/T8 20/5kW (A3:8) F400 (1420 RPM - 32°)	Inlet	74	81	86	91	96	97	97	91	103
HMF 112 T4/T8 20/5kW (A3:8) F400 (720 RPM - 32°)	Inlet	58	65	70	76	80	81	81	75	87
HMF 112 T4/T8 28/6,5kW (A3:8) F400 (1420 RPM - 34°)	Inlet	73	80	85	90	94	96	96	89	101
HMF 112 T4/T8 28/6,5kW (A3:8) F400 (1420 RPM - 40°)	Inlet	74	81	86	90	94	96	95	90	101
HMF 112 T4/T8 28/6,5kW (A3:8) F400 (1420 RPM - 38°)	Inlet	73	80	85	90	94	96	95	89	101

		Sound power Lw dB (A)								
Model		63 Hz	125 Hz	250 Hz	500 Hz	1000 Hz	2000 Hz	4000 Hz	8000 Hz	Total
HMF 112 T4/T8 28/6,5kW (A3:8) F400 (1420 RPM - 36°)	Inlet	73	80	85	90	93	95	95	89	101
HMF 112 T4/T8 28/6,5kW (A3:8) F400 (720 RPM - 40°)	Inlet	58	65	70	74	78	80	80	74	85
HMF 112 T4/T8 28/6,5kW (A3:8) F400 (720 RPM - 38°)	Inlet	57	64	69	74	78	80	80	73	85
HMF 112 T4/T8 28/6,5kW (A3:8) F400 (720 RPM - 36°)	Inlet	57	64	69	74	77	79	80	73	85
HMF 112 T4/T8 28/6,5kW (A3:8) F400 (720 RPM - 34°)	Inlet	57	64	69	74	78	80	80	73	85
HMF 125 T4/T8 11/3kW (A3:4) F400 (1420 RPM - 22°)	Inlet	75	86	91	98	102	103	105	101	109
HMF 125 T4/T8 11/3kW (A3:4) F400 (1420 RPM - 20°)	Inlet	72	85	90	98	102	102	104	101	109
HMF 125 T4/T8 11/3kW (A3:4) F400 (720 RPM - 22°)	Inlet	59	70	75	82	86	87	89	85	93
HMF 125 T4/T8 11/3kW (A3:4) F400 (720 RPM - 20°)	Inlet	56	69	74	82	86	86	88	85	93
HMF 125 T4/T8 14/3,5kW (A3:4) F400 (1420 RPM - 26°)	Inlet	76	84	89	94	98	99	101	95	106
HMF 125 T4/T8 14/3,5kW (A3:4) F400 (1420 RPM - 24°)	Inlet	75	85	90	96	100	101	103	98	107
HMF 125 T4/T8 14/3,5kW (A3:4) F400 (720 RPM - 26°)	Inlet	60	68	73	78	82	83	85	80	90
HMF 125 T4/T8 14/3,5kW (A3:4) F400 (720 RPM - 24°)	Inlet	59	69	74	80	84	85	87	82	91
HMF 125 T4/T8 17/4,3kW (A3:4) F400 (1420 RPM - 28°)	Inlet	75	82	87	93	96	98	99	93	104
HMF 125 T4/T8 17/4,3kW (A3:4) F400 (1420 RPM - 30°)	Inlet	74	81	86	91	95	96	97	91	102
HMF 125 T4/T8 17/4,3kW (A3:4) F400 (720 RPM - 30°)	Inlet	58	65	70	75	79	80	81	75	86
HMF 125 T4/T8 17/4,3kW (A3:4) F400 (720 RPM - 28°)	Inlet	60	67	72	77	80	82	83	77	88
HMF 125 T4/T8 20/5kW (A3:4) F400 (1420 RPM - 34°)	Inlet	73	80	85	90	93	95	96	88	101
HMF 125 T4/T8 20/5kW (A3:4) F400 (1420 RPM - 32°)	Inlet	74	81	86	90	94	96	96	90	102
HMF 125 T4/T8 20/5kW (A3:4) F400 (720 RPM - 34°)	Inlet	58	65	70	74	77	79	80	72	85
HMF 125 T4/T8 20/5kW (A3:4) F400 (720 RPM - 32°)	Inlet	58	65	70	75	78	80	81	74	86
HMF 125 T4/T8 20/5kW (A3:8) F400 (1420 RPM - 24°)	Inlet	78	85	92	100	106	108	108	102	113
HMF 125 T4/T8 20/5kW (A3:8) F400 (1420 RPM - 22°)	Inlet	79	86	93	102	107	110	109	104	114

Sound power Lw dB (A)										
Model		63 Hz	125 Hz	250 Hz	500 Hz	1000 Hz	2000 Hz	4000 Hz	8000 Hz	Total
HMF 125 T4/T8 20/5kW (A3:8) F400 (1420 RPM - 20°)	Inlet	78	86	93	103	108	111	110	105	115
HMF 125 T4/T8 20/5kW (A3:8) F400 (720 RPM - 24°)	Inlet	62	70	76	84	90	92	92	86	97
HMF 125 T4/T8 20/5kW (A3:8) F400 (720 RPM - 22°)	Inlet	63	70	77	86	91	94	93	88	98
HMF 125 T4/T8 20/5kW (A3:8) F400 (720 RPM - 20°)	Inlet	62	71	78	87	92	95	94	89	99
HMF 125 T4/T8 28/6,5kW (A3:4) F400 (1420 RPM - 40°)	Inlet	75	82	87	91	93	96	96	89	102
HMF 125 T4/T8 28/6,5kW (A3:4) F400 (1420 RPM - 38°)	Inlet	74	81	86	91	93	95	96	89	101
HMF 125 T4/T8 28/6,5kW (A3:4) F400 (1420 RPM - 36°)	Inlet	74	81	86	90	93	95	96	88	101
HMF 125 T4/T8 28/6,5kW (A3:4) F400 (720 RPM - 40°)	Inlet	59	66	71	75	78	80	80	73	86
HMF 125 T4/T8 28/6,5kW (A3:4) F400 (720 RPM - 38°)	Inlet	58	65	70	75	77	79	80	73	85
HMF 125 T4/T8 28/6,5kW (A3:4) F400 (720 RPM - 36°)	Inlet	58	65	70	74	77	79	80	72	85
HMF 125 T4/T8 28/6,5kW (A3:8) F400 (1420 RPM - 30°)	Inlet	77	83	90	96	101	103	104	97	108
HMF 125 T4/T8 28/6,5kW (A3:8) F400 (1420 RPM - 28°)	Inlet	78	84	91	97	102	105	105	98	110
HMF 125 T4/T8 28/6,5kW (A3:8) F400 (1420 RPM - 26°)	Inlet	78	85	91	98	104	106	106	100	111
HMF 125 T4/T8 28/6,5kW (A3:8) F400 (720 RPM - 30°)	Inlet	62	67	74	80	85	87	88	81	92
HMF 125 T4/T8 28/6,5kW (A3:8) F400 (720 RPM - 28°)	Inlet	62	68	75	81	86	89	89	82	94
HMF 125 T4/T8 28/6,5kW (A3:8) F400 (720 RPM - 26°)	Inlet	62	69	75	82	88	90	90	84	95
HMF 125 T4/T8 37/9,2kW (A3:8) F400 (1420 RPM - 36°)	Inlet	77	83	89	93	96	98	98	91	104
HMF 125 T4/T8 37/9,2kW (A3:8) F400 (1420 RPM - 34°)	Inlet	77	83	89	94	97	99	100	92	105
HMF 125 T4/T8 37/9,2kW (A3:8) F400 (1420 RPM - 32°)	Inlet	77	83	89	95	99	102	102	94	107
HMF 125 T4/T8 37/9,2kW (A3:8) F400 (720 RPM - 36°)	Inlet	61	68	73	77	81	83	82	75	88
HMF 125 T4/T8 37/9,2kW (A3:8) F400 (720 RPM - 34°)	Inlet	61	68	73	78	81	84	84	76	89
HMF 125 T4/T8 37/9,2kW (A3:8) F400 (720 RPM - 32°)	Inlet	61	67	73	79	83	86	86	79	91
HMF 125 T4/T8 44/11kW (A3:8) F400 (1420 RPM - 40°)	Inlet	76	83	88	93	96	98	97	90	103

Sound power Lw dB (A)										
Model		63 Hz	125 Hz	250 Hz	500 Hz	1000 Hz	2000 Hz	4000 Hz	8000 Hz	Total
HMF 125 T4/T8 44/11kW (A3:8) F400 (1420 RPM - 38°)	Inlet	76	83	88	93	96	98	97	91	104
HMF 125 T4/T8 44/11kW (A3:8) F400 (720 RPM - 40°)	Inlet	60	67	72	77	80	82	81	74	87
HMF 125 T4/T8 44/11kW (A3:8) F400 (720 RPM - 38°)	Inlet	60	67	72	77	80	82	82	75	88

erp data

ERP	
Fan type	Axial fan
Installation category	A
Efficiency category	Static
The fan has to be installed with FSC	No

ERP / 4 poles

Model	Motor power (kW)	Maximum efficiency point data						
		Max. efficiency (%)	Efficiency grade (N) (N)	Air Flow (m3/h)	Ps (Pa)	Pabs (kW)	speed (rpm)	Specific ratio
HMF 45 T4 0,75kW (A5:6) F400 (°)	0,75	25,22	34,25	3.938,40	91,48	0,37	1404	1,00
HMF 50 T4 0,75kW (A5:6) F400 (°)	0,75	33,75	41,93	5.631,13	108,38	0,51	1404	1,00
HMF 56 T4 0,75kW (A5:6) F400 (°)	0,75	38,49	46,08	5.286,46	156,65	0,63	1404	1,00
HMF 56 T4 0,75kW (A5:6) F400 (°)	0,75	38,91	45,71	6.799,71	163,76	0,84	1404	1,00
HMF 56 T4 0,75kW (A5:6) F400 (°)	0,75	40,36	47,48	6.377,29	162,70	0,75	1404	1,00
HMF 56 T4 1,1kW (A5:6) F400 (°)	1,1	35,94	41,99	7.864,11	175,27	1,11	1392	1,00
HMF 56 T4 1,1kW (A5:6) F400 (°)	1,1	37,33	43,85	7.198,19	163,79	0,93	1392	1,00
HMF 56 T4 1,5kW (A5:6) F400 (°)	1,5	35,35	41	8.575,19	185,04	1,28	1410	1,00
HMF 56 T4 1,5kW (A5:6) F400 (°)	1,5	35,43	40,72	9.299,95	193,09	1,46	1410	1,00
HMF 63 T4 0,75kW (A5:6) F400 (°)	0,75	46,63	53,25	7.384,78	192,08	0,90	1404	1,00
HMF 63 T4 1,1kW (A5:6) F400 (°)	1,1	46,52	52,17	9.056,31	221,36	1,28	1392	1,00
HMF 63 T4 1,5kW (A5:6) F400 (°)	1,5	42,12	47,20	10.066,20	229,21	1,58	1410	1,00
HMF 63 T4 1,5kW (A5:6) F400 (°)	1,5	44,39	49,74	9.588,71	224,77	1,43	1410	1,00
HMF 63 T4 2,2kW (A5:6) F400 (°)	2,2	38,35	42,73	11.588,88	230,37	2,03	1420	1,00
HMF 63 T4 2,2kW (A5:6) F400 (°)	2,2	40,03	44,74	10.830,65	229,31	1,81	1420	1,00
HMF 71 T4 0,75kW (A5:6) F400 (°)	0,75	47,01	53,39	7.908,74	201,69	0,98	1404	1,00
HMF 71 T4 1,1kW (A5:6) F400 (°)	1,1	45,67	51,11	9.865,86	221,15	1,39	1392	1,00
HMF 71 T4 1,5kW (A5:6) F400 (°)	1,5	46,22	50,95	11.855,32	240,58	1,80	1410	1,00
HMF 71 T4 2,2kW (A5:6) F400 (°)	2,2	42,32	46,19	14.007,05	256,86	2,46	1420	1,00
HMF 71 T4 2,2kW (A5:6) F400 (°)	2,2	43,85	48,11	12.922	248,26	2,13	1420	1,00
HMF 71 T4 3kW (A5:6) F400 (°)	3	39,37	42,79	15.295,05	255,96	2,89	1420	1,00
HMF 71 T4 3kW (A5:6) F400 (°)	3	40,72	44,36	14.637,66	255,51	2,67	1420	1,00
HMF 80 T4 3kW (A5:6) F400 (°)	3	47,47	50,44	18.603,39	298,09	3,41	1420	1,00
HMF 80 T4 3kW (A5:6) F400 (°)	3	49,89	53,19	17.421,07	297,07	3,02	1420	1,00
HMF 80 T4 3kW (A5:6) F400 (°)	3	53,27	56,95	16.269,95	295,38	2,63	1420	1,00
HMF 80 T4 4kW (A5:6) F400 (°)	4	46,01	48,67	20.008,80	305,30	3,81	1428	1,00
HMF 80 T4 4kW (A5:6) F400 (°)	4	45,44	47,83	21.569,23	310,17	4,22	1428	1,00
HMF 90 T4 3kW (A3:4) F400 (°)	3	48,40	51,64	16.269,79	312,06	3,09	1420	1,00



Model	Motor power (kW)	Maximum efficiency point data						
		Max. efficiency (%)	Efficiency grade (N) (N)	Air Flow (m3/h)	Ps (Pa)	Pabs (kW)	speed (rpm)	Specific ratio
HMF 90 T4 3kW (A3:4) F400 (°)	3	49,88	53,58	14.806,82	298,15	2,61	1420	1,00
HMF 90 T4 4kW (A3:4) F400 (°)	4	46,06	48,49	19.259,13	340,14	4,15	1428	1,00
HMF 90 T4 4kW (A3:4) F400 (°)	4	47,50	50,34	17.768,06	326,89	3,58	1428	1,00
HMF 90 T4 5,5kW (A3:4) F400 (°)	5,5	43,92	45,63	22.345,93	367,81	5,41	1450	1,00
HMF 90 T4 5,5kW (A3:4) F400 (°)	5,5	45,22	47,29	20.822,29	353,92	4,73	1450	1,00
HMF 90 T4 5,5kW (A3:4) F400 (°)	5,5	42,44	43,93	23.455,15	367,14	5,86	1450	1,00
HMF 90 T4 5,5kW (A3:8) F400 (°)	5,5	47,68	49,45	17.497,66	461,40	5,27	1450	1,00
HMF 90 T4 5,5kW (A3:8) F400 (°)	5,5	48,67	50,84	15.786,74	450,04	4,57	1450	1,00
HMF 90 T4 5,5kW (A3:8) F400 (°)	5,5	46,56	47,96	19.242,52	472,46	6,05	1450	1,00
HMF 90 T4 7,5kW (A3:4) F400 (°)	7,5	41,38	42,67	24.607,17	366,35	6,30	1453	1,00
HMF 90 T4 7,5kW (A3:4) F400 (°)	7,5	37,31	38,09	27.009,72	360,41	7,58	1453	1,00
HMF 90 T4 7,5kW (A3:4) F400 (°)	7,5	39,50	40,55	25.787,41	364,05	6,88	1453	1,00
HMF 90 T4 7,5kW (A3:8) F400 (°)	7,5	45,05	45,76	22.907,92	496,52	7,76	1453	1,00
HMF 90 T4 7,5kW (A3:8) F400 (°)	7,5	46,06	47,13	21.070,55	483,55	6,84	1453	1,00
HMF 90 T4 11kW (A3:4) F400 (°)	11	35,47	36,01	28.252,71	356,23	8,28	1470	1,00
HMF 90 T4 11kW (A3:8) F400 (°)	11	40,70	40,69	29.199,51	527,28	11,30	1470	1,00
HMF 90 T4 11kW (A3:8) F400 (°)	11	41,82	41,88	27.753,29	520,19	10,39	1470	1,00
HMF 90 T4 11kW (A3:8) F400 (°)	11	43,24	43,40	26.309,90	515,21	9,50	1470	1,00
HMF 90 T4 11kW (A3:8) F400 (°)	11	44,52	44,93	24.798,94	510,53	8,67	1470	1,00
HMF 90 T4 15kW (A3:8) F400 (°)	15	38,50	38,36	32.064,08	543,37	13,28	1465	1,00
HMF 90 T4 15kW (A3:8) F400 (°)	15	39,99	39,92	30.693,75	535,39	12,16	1465	1,00
HMF 100 T4 5,5kW (A3:4) F400 (°)	5,5	51,87	53,30	26.551,96	401	5,98	1450	1,00
HMF 100 T4 5,5kW (A3:4) F400 (°)	5,5	53,50	55,28	24.581,71	393,08	5,28	1450	1,00
HMF 100 T4 5,5kW (A3:4) F400 (°)	5,5	55,29	57,42	22.619,79	386,25	4,64	1450	1,00
HMF 100 T4 5,5kW (A3:4) F400 (°)	5,5	56,41	58,86	20.842,55	377,22	4,11	1450	1,00
HMF 100 T4 7,5kW (A3:4) F400 (°)	7,5	49,06	49,88	30.676,32	415,55	7,49	1453	1,00
HMF 100 T4 7,5kW (A3:4) F400 (°)	7,5	50,77	51,90	28.592,36	409,27	6,67	1453	1,00
HMF 100 T4 7,5kW (A3:8) F400 (°)	7,5	55,47	56,16	23.417,68	607,83	7,82	1453	1,00
HMF 100 T4 11kW (A3:4) F400 (°)	11	41,52	41,52	37.883,88	424,19	11,15	1470	1,00
HMF 100 T4 11kW (A3:4) F400 (°)	11	43,81	43,89	35.974,38	428,43	10,10	1470	1,00
HMF 100 T4 11kW (A3:4) F400 (°)	11	45,92	46,20	34.144,20	427,62	9,11	1470	1,00
HMF 100 T4 11kW (A3:4) F400 (°)	11	47,76	48,32	32.382,92	421,97	8,22	1470	1,00
HMF 100 T4 11kW (A3:8) F400 (°)	11	51,03	51,01	31.641,86	617,34	11,55	1470	1,00
HMF 100 T4 11kW (A3:8) F400 (°)	11	53,94	54,11	27.456,87	612,59	9,47	1470	1,00
HMF 100 T4 11kW (A3:8) F400 (°)	11	55,20	55,65	25.420,36	610,20	8,56	1470	1,00
HMF 100 T4 11kW (A3:8) F400 (°)	11	52,54	52,58	29.528,86	615,77	10,48	1470	1,00
HMF 100 T4 15kW (A3:4) F400 (°)	15	39,45	39,38	39.773,65	420,72	12,24	1465	1,00
HMF 100 T4 15kW (A3:8) F400 (°)	15	47,09	46,83	38.099,12	641,83	15,45	1465	1,00



Model	Motor power (kW)	Maximum efficiency point data						
		Max. efficiency (%)	Efficiency grade (N) (N)	Air Flow (m3/h)	Ps (Pa)	Pabs (kW)	speed (rpm)	Specific ratio
HMF 100 T4 15kW (A3:8) F400 (°)	15	48,58	48,41	35.858,39	631,14	13,92	1465	1,00
HMF 100 T4 15kW (A3:8) F400 (°)	15	50,05	49,95	33.667,23	620,57	12,57	1465	1,00
HMF 100 T4 18,5kW (A3:8) F400 (°)	18,5	43,92	43,51	42.881,99	657,50	18,71	1465	1,00
HMF 100 T4 18,5kW (A3:8) F400 (°)	18,5	45,47	45,14	40.435,64	650,15	17,04	1465	1,00
HMF 100 T4 22kW (A3:8) F400 (°)	22	42,42	41,94	45.506,86	663,64	20,54	1465	1,00
HMF 112 T4 5,5kW (A3:4) F400 (°)	5,5	58,57	60,07	25.650,99	454,24	5,82	1450	1,00
HMF 112 T4 7,5kW (A3:4) F400 (°)	7,5	57,62	58,79	28.722,21	445,68	6,56	1453	1,00
HMF 112 T4 7,5kW (A3:4) F400 (°)	7,5	56,18	57,03	31.958,45	439,65	7,40	1453	1,00
HMF 112 T4 11kW (A3:4) F400 (°)	11	50,77	50,76	45.167,47	447,36	11,30	1470	1,00
HMF 112 T4 11kW (A3:4) F400 (°)	11	52,52	52,59	42.650,78	440,51	10,20	1470	1,00
HMF 112 T4 11kW (A3:4) F400 (°)	11	54,03	54,29	38.950,75	437	9,18	1470	1,00
HMF 112 T4 11kW (A3:4) F400 (°)	11	55,47	56,03	35.408,75	436,25	8,21	1470	1,00
HMF 112 T4 11kW (A3:8) F400 (°)	11	59,52	59,49	33.497,64	695,11	11,64	1470	1,00
HMF 112 T4 11kW (A3:8) F400 (°)	11	59,41	59,44	30.195,59	708	10,66	1470	1,00
HMF 112 T4 15kW (A3:8) F400 (°)	15	57,78	57,60	40.666,11	670,97	14,07	1465	1,00
HMF 112 T4 15kW (A3:8) F400 (°)	15	59,10	58,99	37.062,48	681,23	12,72	1465	1,00
HMF 112 T4 15kW (A3:8) F400 (°)	15	56,50	56,24	44.285,27	663,23	15,50	1465	1,00
HMF 112 T4 18,5kW (A3:8) F400 (°)	18,5	53,40	52,98	51.076,20	674,33	18,96	1465	1,00
HMF 112 T4 18,5kW (A3:8) F400 (°)	18,5	55,48	55,15	47.984,32	657,81	16,90	1465	1,00
HMF 112 T4 22kW (A3:8) F400 (°)	22	51,62	51,12	54.223,31	690,24	21,10	1465	1,00
HMF 112 T4 22kW (A3:8) F400 (°)	22	49,77	49,20	57.042,61	699,22	23,14	1465	1,00
HMF 112 T4 30kW (A3:8) F400 (°)	30	46,45	45,76	62.509,16	704,62	27,06	1470	1,00
HMF 112 T4 30kW (A3:8) F400 (°)	30	48,48	47,85	59.738,16	701,78	24,86	1470	1,00
HMF 125 T4 11kW (A3:4) F400 (°)	11	58,21	58,24	38.867,01	544,20	10,72	1470	1,00
HMF 125 T4 11kW (A3:4) F400 (°)	11	59,70	59,89	34.627,57	555,89	9,43	1470	1,00
HMF 125 T4 15kW (A3:4) F400 (°)	15	54,41	54,17	52.641,94	533,79	15,06	1465	1,00
HMF 125 T4 15kW (A3:4) F400 (°)	15	55,99	55,85	47.908,39	532,86	13,44	1465	1,00
HMF 125 T4 15kW (A3:4) F400 (°)	15	57,13	57,08	43.235,32	536,37	12,01	1465	1,00
HMF 125 T4 18,5kW (A3:4) F400 (°)	18,5	51,38	50,99	60.950,03	546,90	18,40	1465	1,00
HMF 125 T4 18,5kW (A3:4) F400 (°)	18,5	53,14	52,83	57.616,06	538,43	16,65	1465	1,00
HMF 125 T4 18,5kW (A3:8) F400 (°)	18,5	60,33	59,91	45.513,87	844,37	18,92	1465	1,00
HMF 125 T4 18,5kW (A3:8) F400 (°)	18,5	60,17	59,82	40.816,50	865,45	17,39	1465	1,00
HMF 125 T4 22kW (A3:4) F400 (°)	22	46,40	45,84	67.695,79	552,09	22,74	1465	1,00
HMF 125 T4 22kW (A3:4) F400 (°)	22	49,42	48,94	64.631,14	554,34	20,49	1465	1,00
HMF 125 T4 22kW (A3:8) F400 (°)	22	59,65	59,16	50.101,18	832,37	20,84	1465	1,00
HMF 125 T4 22kW (A3:8) F400 (°)	22	58,26	57,69	54.888,01	820,52	23,04	1465	1,00
HMF 125 T4 30kW (A3:8) F400 (°)	30	55,98	55,28	64.842,17	805,03	27,60	1470	1,00
HMF 125 T4 30kW (A3:8) F400 (°)	30	57,49	56,85	59.887,35	810,69	25,16	1470	1,00



Model	Motor power (kW)	Maximum efficiency point data						
		Max. efficiency (%)	Efficiency grade (N) (N)	Air Flow (m3/h)	Ps (Pa)	Pabs (kW)	speed (rpm)	Specific ratio
HMF 125 T4 30kW (A3:8) F400 (°)	30	53,89	53,09	68.709,09	827,35	30,96	1470	1,00
HMF 125 T4 37kW (A3:8) F400 (°)	37	50,51	49,55	77.349,10	853,45	37,87	1475	1,00
HMF 125 T4 37kW (A3:8) F400 (°)	37	52,01	51,13	73.025,87	843,98	34,43	1475	1,00
HMF 125 T4 45kW (A3:8) F400 (°)	45	46,52	45,44	84.191,86	861,51	44,34	1475	1,00
HMF 125 T4 45kW (A3:8) F400 (°)	45	48,98	47,97	80.875,45	856,90	40,79	1475	1,00

ERP / 6 poles

Model	Motor power (kW)	Maximum efficiency point data						
		Max. efficiency (%)	Efficiency grade (N) (N)	Air Flow (m3/h)	Ps (Pa)	Pabs (kW)	speed (rpm)	Specific ratio
HMF 50 T6 0,75kW (A5:6) F400 (°)	0,75	26,51	37,89	3.801,51	49,14	0,16	923	1,00
HMF 56 T6 0,75kW (A5:6) F400 (°)	0,55	30,33	38,94	5.459,45	84,52	0,44	923	1,00
HMF 63 T6 0,75kW (A5:6) F400 (°)	0,55	34,06	41,69	7.615,85	94,49	0,62	923	1,00
HMF 71 T6 0,75kW (A5:6) F400 (°)	0,75	30,27	36,76	9.801,75	101,01	0,94	923	1,00
HMF 71 T6 0,75kW (A5:6) F400 (°)	0,75	31,83	38,57	9.342,20	101,35	0,86	923	1,00
HMF 71 T6 0,75kW (A5:6) F400 (°)	0,75	33,76	40,76	8.892	102,10	0,78	923	1,00
HMF 80 T6 0,75kW (A5:6) F400 (°)	0,75	46,42	53,13	10.781,95	130,20	0,87	923	1,00
HMF 80 T6 1,1kW (A5:6) F400 (°)	1,1	45,75	52,11	11.564,61	135,49	0,99	920	1,00
HMF 80 T6 1,1kW (A5:6) F400 (°)	1,1	45,38	51,44	12.346,06	140,98	1,11	920	1,00
HMF 80 T6 1,5kW (A5:6) F400 (°)	1,5	43,39	49,15	13.270,90	139,67	1,23	933	1,00
HMF 80 T6 1,5kW (A5:6) F400 (°)	1,5	42,03	47,52	14.230,04	138,45	1,36	933	1,00
HMF 80 T6 2,2kW (A5:6) F400 (°)	2,2	35,88	40,81	15.634,47	132,64	1,67	948	1,00
HMF 90 T6 1,5kW (A3:4) F400 (°)	1,5	44,99	51,97	9.583,78	124,98	0,79	933	1,00
HMF 90 T6 1,5kW (A3:4) F400 (°)	1,5	42,25	48,02	12.493,84	142,68	1,23	933	1,00
HMF 90 T6 1,5kW (A3:4) F400 (°)	1,5	44,95	51,55	10.556,97	131,26	0,91	933	1,00
HMF 90 T6 1,5kW (A3:4) F400 (°)	1,5	40,51	45,57	14.458,45	154,42	1,59	933	1,00
HMF 90 T6 1,5kW (A3:4) F400 (°)	1,5	43,62	49,78	11.508,58	137,15	1,06	933	1,00
HMF 90 T6 1,5kW (A3:4) F400 (°)	1,5	39,16	44	15.175,88	153,82	1,73	933	1,00
HMF 90 T6 1,5kW (A3:4) F400 (°)	1,5	41,76	47,18	13.448,72	148,79	1,39	933	1,00
HMF 90 T6 1,5kW (A3:8) F400 (°)	1,5	43,13	47,88	12.501,64	197,85	1,78	933	1,00
HMF 90 T6 1,5kW (A3:8) F400 (°)	1,5	44,11	49,24	11.328,69	193,42	1,55	933	1,00
HMF 90 T6 1,5kW (A3:8) F400 (°)	1,5	44,93	50,45	10.229,46	188,94	1,34	933	1,00
HMF 90 T6 2,2kW (A3:4) F400 (°)	2,2	36,98	41,41	16.731,31	152,65	2	948	1,00
HMF 90 T6 2,2kW (A3:4) F400 (°)	2,2	32,98	36,88	18.362,87	149,62	2,43	948	1,00
HMF 90 T6 2,2kW (A3:4) F400 (°)	2,2	34,92	39,08	17.489,63	151,36	2,20	948	1,00
HMF 90 T6 2,2kW (A3:4) F400 (°)	2,2	38,76	43,43	15.956,21	153,67	1,83	948	1,00



Model	Motor power (kW)	Maximum efficiency point data						
		Max. efficiency (%)	Efficiency grade (N) (N)	Air Flow (m3/h)	Ps (Pa)	Pabs (kW)	speed (rpm)	Specific ratio
HMF 90 T6 2,2kW (A3:8) F400 (°)	2,2	41,21	44,98	16.064,98	214,09	2,54	948	1,00
HMF 90 T6 2,2kW (A3:8) F400 (°)	2,2	42,13	46,22	14.838,62	208,75	2,26	948	1,00
HMF 90 T6 2,2kW (A3:8) F400 (°)	2,2	43,04	47,49	13.628,47	203,46	1,99	948	1,00
HMF 90 T6 3kW (A3:8) F400 (°)	3	38,31	41,40	18.908,19	221,14	3,26	965	1,00
HMF 90 T6 3kW (A3:8) F400 (°)	3	39,43	42,75	18.011,07	218,50	3	965	1,00
HMF 90 T6 3kW (A3:8) F400 (°)	3	40,73	44,29	17.055,17	216,34	2,75	965	1,00
HMF 90 T6 4kW (A3:8) F400 (°)	4	36,47	39,13	20.775,85	228	3,81	963	1,00
HMF 90 T6 4kW (A3:8) F400 (°)	4	37,78	40,68	19.832,49	224,67	3,50	963	1,00
HMF 100 T6 1,5kW (A3:4) F400 (°)	1,5	48	52,79	17.179,76	168,57	1,76	933	1,00
HMF 100 T6 1,5kW (A3:4) F400 (°)	1,5	51,69	57,48	13.485,58	158,21	1,22	933	1,00
HMF 100 T6 1,5kW (A3:4) F400 (°)	1,5	49,51	54,63	15.922,72	165,18	1,55	933	1,00
HMF 100 T6 1,5kW (A3:4) F400 (°)	1,5	51,08	56,56	14.653,56	161,73	1,36	933	1,00
HMF 100 T6 2,2kW (A3:4) F400 (°)	1,5	48	52,79	17.179,76	168,57	1,76	948	1,00
HMF 100 T6 2,2kW (A3:4) F400 (°)	1,5	51,69	57,48	13.485,58	158,21	1,22	948	1,00
HMF 100 T6 2,2kW (A3:4) F400 (°)	2,2	44,23	48,15	20.995,57	176,96	2,42	948	1,00
HMF 100 T6 2,2kW (A3:4) F400 (°)	2,2	45,96	50,16	19.862,23	174,86	2,18	948	1,00
HMF 100 T6 2,2kW (A3:4) F400 (°)	2,2	47,55	52,06	18.545,55	171,45	1,94	948	1,00
HMF 100 T6 2,2kW (A3:4) F400 (°)	1,5	49,51	54,63	15.922,72	165,18	1,55	948	1,00
HMF 100 T6 2,2kW (A3:4) F400 (°)	1,5	51,08	56,56	14.653,56	161,73	1,36	948	1,00
HMF 100 T6 2,2kW (A3:8) F400 (°)	2,2	51,21	55,01	16.476,91	256,68	2,51	948	1,00
HMF 100 T6 2,2kW (A3:8) F400 (°)	2,2	51,92	55,99	15.169,13	255,11	2,28	948	1,00
HMF 100 T6 3kW (A3:4) F400 (°)	3	38,98	42,10	24.548,30	178	3,23	965	1,00
HMF 100 T6 3kW (A3:4) F400 (°)	3	43,18	46,85	22.123,26	179,46	2,64	965	1,00
HMF 100 T6 3kW (A3:4) F400 (°)	3	41,08	44,48	23.289,51	179,45	2,92	965	1,00
HMF 100 T6 3kW (A3:8) F400 (°)	3	50,84	54,42	17.792,04	257,31	2,74	965	1,00
HMF 100 T6 3kW (A3:8) F400 (°)	3	47,99	51,02	20.468,71	259,15	3,34	965	1,00
HMF 100 T6 3kW (A3:8) F400 (°)	3	49,37	52,67	19.128,02	258,39	3,03	965	1,00
HMF 100 T6 4kW (A3:4) F400 (°)	4	37,30	40,18	25.772,81	176,56	3,52	963	1,00
HMF 100 T6 4kW (A3:8) F400 (°)	4	44,50	46,75	24.680,80	269,11	4,44	963	1,00
HMF 100 T6 4kW (A3:8) F400 (°)	4	45,88	48,41	23.240,09	265,30	4,01	963	1,00
HMF 100 T6 4kW (A3:8) F400 (°)	4	47,24	50,05	21.823,06	259,99	3,61	963	1,00
HMF 100 T6 5,5kW (A3:8) F400 (°)	5,5	43,47	45,48	26.154,22	273,04	4,85	960	1,00
HMF 100 T6 5,5kW (A3:8) F400 (°)	5,5	40,35	41,83	29.503,31	278,58	5,88	960	1,00
HMF 100 T6 5,5kW (A3:8) F400 (°)	5,5	41,89	43,63	27.803,89	275,54	5,34	960	1,00
HMF 112 T6 2,2kW (A3:4) F400 (°)	2,2	51,44	55,36	22.980,29	183,02	2,41	948	1,00
HMF 112 T6 2,2kW (A3:4) F400 (°)	2,2	52,53	56,76	20.748,94	183,87	2,15	948	1,00
HMF 112 T6 2,2kW (A3:4) F400 (°)	2,2	53,88	58,45	18.574,72	187,51	1,91	948	1,00
HMF 112 T6 2,2kW (A3:4) F400 (°)	2,2	54,23	59,09	16.623,41	190,80	1,71	948	1,00

Model	Motor power (kW)	Maximum efficiency point data						
		Max. efficiency (%)	Efficiency grade (N) (N)	Air Flow (m3/h)	Ps (Pa)	Pabs (kW)	speed (rpm)	Specific ratio
HMF 112 T6 3kW (A3:4) F400 (°)	3	50,81	54,47	25.245,67	183,08	2,66	965	1,00
HMF 112 T6 3kW (A3:4) F400 (°)	3	47,73	50,82	29.265,33	187,47	3,26	965	1,00
HMF 112 T6 3kW (A3:4) F400 (°)	3	49,40	52,76	27.623,78	184,84	2,95	965	1,00
HMF 112 T6 3kW (A3:8) F400 (°)	3	56	59,01	21.778,10	290,64	3,36	965	1,00
HMF 112 T6 3kW (A3:8) F400 (°)	3	55,92	59,16	19.608,60	296,90	3,08	965	1,00
HMF 112 T6 4kW (A3:4) F400 (°)	4	40,84	43,13	33.937,50	184,85	4,37	963	1,00
HMF 112 T6 4kW (A3:4) F400 (°)	4	43,64	46,18	32.509,70	189,55	3,99	963	1,00
HMF 112 T6 4kW (A3:4) F400 (°)	4	46,20	49,02	30.958,51	190,42	3,60	963	1,00
HMF 112 T6 4kW (A3:8) F400 (°)	4	53,43	55,66	28.677,77	278,34	4,46	963	1,00
HMF 112 T6 4kW (A3:8) F400 (°)	4	54,62	57,12	26.316,98	281,58	4,05	963	1,00
HMF 112 T6 4kW (A3:8) F400 (°)	4	55,86	58,64	24.040,42	285,48	3,66	963	1,00
HMF 112 T6 5,5kW (A3:4) F400 (°)	5,5	38,56	40,63	35.410,86	180,06	4,74	960	1,00
HMF 112 T6 5,5kW (A3:8) F400 (°)	5,5	52,93	54,95	31.076,68	276,36	4,82	960	1,00
HMF 112 T6 5,5kW (A3:8) F400 (°)	5,5	49,03	50,43	35.104,47	289,64	6,04	960	1,00
HMF 112 T6 5,5kW (A3:8) F400 (°)	5,5	50,96	52,67	33.100,89	283,06	5,40	960	1,00
HMF 112 T6 7,5kW (A3:8) F400 (°)	7,5	46,28	47,24	38.694,32	294,24	7,08	970	1,00
HMF 112 T6 7,5kW (A3:8) F400 (°)	7,5	47,84	49,02	36.964,24	293,63	6,55	970	1,00
HMF 112 T6 7,5kW (A3:8) F400 (°)	7,5	44,41	45,14	40.492,81	295,56	7,70	970	1,00
HMF 125 T6 3kW (A3:4) F400 (°)	3	53,40	56,30	28.018,57	225,20	3,50	965	1,00
HMF 125 T6 3kW (A3:4) F400 (°)	3	54,75	57,98	25.151,44	228,34	3,10	965	1,00
HMF 125 T6 3kW (A3:4) F400 (°)	3	56,19	59,78	22.380,14	234,07	2,72	965	1,00
HMF 125 T6 4kW (A3:4) F400 (°)	4	52,93	55,56	31.002,15	223,93	3,87	963	1,00
HMF 125 T6 4kW (A3:4) F400 (°)	4	51,57	53,88	34.126,02	224,01	4,32	963	1,00
HMF 125 T6 5,5kW (A3:4) F400 (°)	5,5	46,86	48,34	41.817,50	232,85	5,87	960	1,00
HMF 125 T6 5,5kW (A3:4) F400 (°)	5,5	49,08	50,87	39.514,98	229,55	5,24	960	1,00
HMF 125 T6 5,5kW (A3:4) F400 (°)	5,5	50,80	52,87	37.300,23	226,18	4,74	960	1,00
HMF 125 T6 5,5kW (A3:8) F400 (°)	5,5	56,65	58,09	32.472,13	349,36	5,96	960	1,00
HMF 125 T6 5,5kW (A3:8) F400 (°)	5,5	57,62	59,33	29.427,43	355,11	5,39	960	1,00
HMF 125 T6 5,5kW (A3:8) F400 (°)	5,5	57,44	59,39	26.471,98	362,86	4,95	960	1,00
HMF 125 T6 7,5kW (A3:8) F400 (°)	7,5	53,64	54,32	42.032,28	337,28	7,86	970	1,00
HMF 125 T6 7,5kW (A3:8) F400 (°)	7,5	54,83	55,77	38.760,28	340,40	7,17	970	1,00
HMF 125 T6 7,5kW (A3:8) F400 (°)	7,5	56,09	57,28	35.571,49	344,23	6,51	970	1,00
HMF 125 T6 11kW (A3:8) F400 (°)	11	46,87	46,84	52.275,06	360,26	11,53	970	1,00
HMF 125 T6 11kW (A3:8) F400 (°)	11	48,44	48,48	49.919,01	358,48	10,67	970	1,00
HMF 125 T6 11kW (A3:8) F400 (°)	11	50,25	50,35	47.408,37	353,84	9,71	970	1,00
HMF 125 T6 11kW (A3:8) F400 (°)	11	52,34	52,75	44.711,09	346,17	8,69	970	1,00
HMF 125 T6 15kW (A3:8) F400 (°)	15	45,55	45,47	54.803,88	361,22	12,43	970	1,00

ERP / 4/6 poles

Model	Motor power (kW)	Maximum efficiency point data						
		Max. efficiency (%)	Efficiency grade (N) (N)	Air Flow (m3/h)	Ps (Pa)	Pabs (kW)	speed (rpm)	Specific ratio
HMF 45 T4/T6 0,75/0,25kW (A5:6) F400 (°)	0,75/0,25	25,22	34,25	3.938,40	91,48	0,37	1500	1,00
HMF 50 T4/T6 0,75/0,25kW (A5:6) F400 (°)	0,75/0,25	33,75	41,93	5.631,13	108,38	0,51	1500	1,00
HMF 56 T4/T6 0,75/0,25kW (A5:6) F400 (°)	0,75/0,25	38,91	45,71	6.799,71	163,76	0,84	1500	1,00
HMF 56 T4/T6 0,75/0,25kW (A5:6) F400 (°)	0,75/0,25	40,36	47,48	6.377,29	162,70	0,75	1500	1,00
HMF 56 T4/T6 0,75/0,25kW (A5:6) F400 (°)	0,75/0,25	38,49	46,08	5.286,46	156,65	0,63	1500	1,00
HMF 56 T4/T6 1,1/0,3kW (A5:6) F400 (°)	1,1/0,3	35,94	41,99	7.864,11	175,27	1,11	1500	1,00
HMF 56 T4/T6 1,1/0,3kW (A5:6) F400 (°)	1,1/0,3	37,33	43,85	7.198,19	163,79	0,93	1500	1,00
HMF 56 T4/T6 1,5/0,37kW (A5:6) F400 (°)	1,5/0,37	35,43	40,72	9.299,95	193,09	1,46	1500	1,00
HMF 56 T4/T6 1,5/0,37kW (A5:6) F400 (°)	1,5/0,37	35,35	41	8.575,19	185,04	1,28	1500	1,00
HMF 63 T4/T6 0,75/0,25kW (A5:6) F400 (°)	0,75/0,25	46,63	53,25	7.384,78	192,08	0,90	1500	1,00
HMF 63 T4/T6 1,1/0,3kW (A5:6) F400 (°)	1,1/0,3	46,52	52,17	9.056,31	221,36	1,28	1500	1,00
HMF 63 T4/T6 1,5/0,37kW (A5:6) F400 (°)	1,5/0,37	42,12	47,20	10.066,20	229,21	1,58	1500	1,00
HMF 63 T4/T6 1,5/0,37kW (A5:6) F400 (°)	1,5/0,37	44,39	49,74	9.588,71	224,77	1,43	1500	1,00
HMF 63 T4/T6 2,2/0,7kW (A5:6) F400 (°)	2,2/0,7	38,35	42,73	11.588,88	230,37	2,03	1500	1,00
HMF 63 T4/T6 2,2/0,7kW (A5:6) F400 (°)	2,2/0,7	40,03	44,74	10.830,65	229,31	1,81	1500	1,00
HMF 71 T4/T6 0,75/0,25kW (A5:6) F400 (°)	0,75/0,25	47,01	53,39	7.908,74	201,69	0,98	1500	1,00
HMF 71 T4/T6 1,1/0,3kW (A5:6) F400 (°)	1,1/0,3	45,67	51,11	9.865,86	221,15	1,39	1500	1,00
HMF 71 T4/T6 1,5/0,37kW (A5:6) F400 (°)	1,5/0,37	46,22	50,95	11.855,32	240,58	1,80	1500	1,00
HMF 71 T4/T6 2,2/0,7kW (A5:6) F400 (°)	2,2/0,7	42,32	46,19	14.007,05	256,86	2,46	1500	1,00
HMF 71 T4/T6 2,2/0,7kW (A5:6) F400 (°)	2,2/0,7	43,85	48,11	12.922	248,26	2,13	1500	1,00
HMF 71 T4/T6 3/1kW (A5:6) F400 (°)	3/1	39,37	42,79	15.295,05	255,96	2,89	1500	1,00
HMF 71 T4/T6 3/1kW (A5:6) F400 (°)	3/1	40,72	44,36	14.637,66	255,51	2,67	1500	1,00
HMF 80 T4/T6 3/1kW (A5:6) F400 (°)	3/1	47,47	50,44	18.603,39	298,09	3,41	1500	1,00
HMF 80 T4/T6 3/1kW (A5:6) F400 (°)	3/1	49,89	53,19	17.421,07	297,07	3,02	1500	1,00
HMF 80 T4/T6 3/1kW (A5:6) F400 (°)	3/1	53,27	56,95	16.269,95	295,38	2,63	1500	1,00
HMF 80 T4/T6 4,5/1,5kW (A5:6) F400 (°)	4,5/1,5	46,01	48,67	20.008,80	305,30	3,81	1500	1,00
HMF 80 T4/T6 4,5/1,5kW (A5:6) F400 (°)	4,5/1,5	45,44	47,83	21.569,23	310,17	4,22	1500	1,00
HMF 90 T4/T6 3/1kW (A3:4) F400 (°)	3/1	48,40	51,64	16.269,79	312,06	3,09	1420	1,00
HMF 90 T4/T6 3/1kW (A3:4) F400 (°)	3/1	49,88	53,58	14.806,82	298,15	2,61	1420	1,00
HMF 90 T4/T6 4,5/1,5kW (A3:4) F400 (°)	4,5/1,5	45,22	47,29	20.822,29	353,92	4,73	1420	1,00
HMF 90 T4/T6 4,5/1,5kW (A3:4) F400 (°)	4,5/1,5	46,06	48,49	19.259,13	340,14	4,15	1420	1,00
HMF 90 T4/T6 4,5/1,5kW (A3:4) F400 (°)	4,5/1,5	47,50	50,34	17.768,06	326,89	3,58	1420	1,00
HMF 90 T4/T6 4,5/1,5kW (A3:8) F400 (°)	4,5/1,5	48,67	50,84	15.786,74	450,04	4,57	1420	1,00
HMF 90 T4/T6 6/2,2kW (A3:4) F400 (°)	6/2,2	41,38	42,67	24.607,17	366,35	6,30	1420	1,00
HMF 90 T4/T6 6/2,2kW (A3:4) F400 (°)	6/2,2	43,92	45,63	22.345,93	367,81	5,41	1420	1,00
HMF 90 T4/T6 6/2,2kW (A3:4) F400 (°)	6/2,2	42,44	43,93	23.455,15	367,14	5,86	1420	1,00



Model	Motor power (kW)	Maximum efficiency point data						
		Max. efficiency (%)	Efficiency grade (N) (N)	Air Flow (m3/h)	Ps (Pa)	Pabs (kW)	speed (rpm)	Specific ratio
HMF 90 T4/T6 6/2,2kW (A3:8) F400 (°)	6/2,2	47,68	49,45	17.497,66	461,40	5,27	1420	1,00
HMF 90 T4/T6 6/2,2kW (A3:8) F400 (°)	6/2,2	46,56	47,96	19.242,52	472,46	6,05	1420	1,00
HMF 90 T4/T6 10/3,3kW (A3:4) F400 (°)	10/3,3	35,47	36,01	28.252,71	356,23	8,28	1420	1,00
HMF 90 T4/T6 10/3,3kW (A3:4) F400 (°)	10/3,3	37,31	38,09	27.009,72	360,41	7,58	1420	1,00
HMF 90 T4/T6 10/3,3kW (A3:4) F400 (°)	10/3,3	39,50	40,55	25.787,41	364,05	6,88	1420	1,00
HMF 90 T4/T6 10/3,3kW (A3:8) F400 (°)	10/3,3	41,82	41,88	27.753,29	520,19	10,39	1420	1,00
HMF 90 T4/T6 10/3,3kW (A3:8) F400 (°)	10/3,3	45,05	45,76	22.907,92	496,52	7,76	1420	1,00
HMF 90 T4/T6 10/3,3kW (A3:8) F400 (°)	10/3,3	46,06	47,13	21.070,55	483,55	6,84	1420	1,00
HMF 90 T4/T6 10/3,3kW (A3:8) F400 (°)	10/3,3	43,24	43,40	26.309,90	515,21	9,50	1420	1,00
HMF 90 T4/T6 10/3,3kW (A3:8) F400 (°)	10/3,3	44,52	44,93	24.798,94	510,53	8,67	1420	1,00
HMF 90 T4/T6 14/4,5kW (A3:8) F400 (°)	14/4,5	40,70	40,69	29.199,51	527,28	11,30	1420	1,00
HMF 90 T4/T6 14/4,5kW (A3:8) F400 (°)	14/4,5	38,50	38,36	32.064,08	543,37	13,28	1420	1,00
HMF 90 T4/T6 14/4,5kW (A3:8) F400 (°)	14/4,5	39,99	39,92	30.693,75	535,39	12,16	1420	1,00
HMF 100 T4/T6 4,5/1,5kW (A3:4) F400 (°)	4,5/1,5	55,29	57,42	22.619,79	386,25	4,64	1420	1,00
HMF 100 T4/T6 4,5/1,5kW (A3:4) F400 (°)	4,5/1,5	56,41	58,86	20.842,55	377,22	4,11	1420	1,00
HMF 100 T4/T6 6/2,2kW (A3:4) F400 (°)	6/2,2	51,87	53,30	26.551,96	401	5,98	1420	1,00
HMF 100 T4/T6 6/2,2kW (A3:4) F400 (°)	6/2,2	53,50	55,28	24.581,71	393,08	5,28	1420	1,00
HMF 100 T4/T6 10/3,3kW (A3:4) F400 (°)	10/3,3	49,06	49,88	30.676,32	415,55	7,49	1420	1,00
HMF 100 T4/T6 10/3,3kW (A3:4) F400 (°)	10/3,3	43,81	43,89	35.974,38	428,43	10,10	1420	1,00
HMF 100 T4/T6 10/3,3kW (A3:4) F400 (°)	10/3,3	45,92	46,20	34.144,20	427,62	9,11	1420	1,00
HMF 100 T4/T6 10/3,3kW (A3:4) F400 (°)	10/3,3	47,76	48,32	32.382,92	421,97	8,22	1420	1,00
HMF 100 T4/T6 10/3,3kW (A3:4) F400 (°)	10/3,3	50,77	51,90	28.592,36	409,27	6,67	1420	1,00
HMF 100 T4/T6 10/3,3kW (A3:8) F400 (°)	10/3,3	53,94	54,11	27.456,87	612,59	9,47	1420	1,00
HMF 100 T4/T6 10/3,3kW (A3:8) F400 (°)	10/3,3	55,20	55,65	25.420,36	610,20	8,56	1420	1,00
HMF 100 T4/T6 10/3,3kW (A3:8) F400 (°)	10/3,3	51,03	51,01	31.641,86	617,34	11,55	1420	1,00
HMF 100 T4/T6 10/3,3kW (A3:8) F400 (°)	10/3,3	52,54	52,58	29.528,86	615,77	10,48	1420	1,00
HMF 100 T4/T6 10/3,3kW (A3:8) F400 (°)	10/3,3	55,47	56,16	23.417,68	607,83	7,82	1420	1,00
HMF 100 T4/T6 14/4,5kW (A3:4) F400 (°)	14/4,5	39,45	39,38	39.773,65	420,72	12,24	1420	1,00
HMF 100 T4/T6 14/4,5kW (A3:4) F400 (°)	14/4,5	41,52	41,52	37.883,88	424,19	11,15	1420	1,00
HMF 100 T4/T6 14/4,5kW (A3:8) F400 (°)	14/4,5	51,03	51,01	31.641,86	617,34	11,55	1420	1,00
HMF 100 T4/T6 14/4,5kW (A3:8) F400 (°)	14/4,5	48,58	48,41	35.858,39	631,14	13,92	1420	1,00
HMF 100 T4/T6 14/4,5kW (A3:8) F400 (°)	14/4,5	50,05	49,95	33.667,23	620,57	12,57	1420	1,00
HMF 100 T4/T6 16/6,5kW (A3:8) F400 (°)	16/6,5	47,09	46,83	38.099,12	641,83	15,45	1420	1,00
HMF 100 T4/T6 20/8,5kW (A3:8) F400 (°)	20/8,5	43,92	43,51	42.881,99	657,50	18,71	1420	1,00
HMF 100 T4/T6 20/8,5kW (A3:8) F400 (°)	20/8,5	45,47	45,14	40.435,64	650,15	17,04	1420	1,00
HMF 100 T4/T6 20/8,5kW (A3:8) F400 (°)	20/8,5	42,42	41,94	45.506,86	663,64	20,54	1420	1,00
HMF 112 T4/T6 6/2,2kW (A3:4) F400 (°)	6/2,2	57,62	58,79	28.722,21	445,68	6,56	1420	1,00
HMF 112 T4/T6 6/2,2kW (A3:4) F400 (°)	6/2,2	58,57	60,07	25.650,99	454,24	5,82	1420	1,00

Model	Motor power (kW)	Maximum efficiency point data						
		Max. efficiency (%)	Efficiency grade (N) (N)	Air Flow (m3/h)	Ps (Pa)	Pabs (kW)	speed (rpm)	Specific ratio
HMF 112 T4/T6 10/3,3kW (A3:4) F400 (°)	10/3,3	52,52	52,59	42.650,78	440,51	10,20	1420	1,00
HMF 112 T4/T6 10/3,3kW (A3:4) F400 (°)	10/3,3	54,03	54,29	38.950,75	437	9,18	1420	1,00
HMF 112 T4/T6 10/3,3kW (A3:4) F400 (°)	10/3,3	55,47	56,03	35.408,75	436,25	8,21	1420	1,00
HMF 112 T4/T6 10/3,3kW (A3:4) F400 (°)	10/3,3	56,18	57,03	31.958,45	439,65	7,40	1420	1,00
HMF 112 T4/T6 14/4,5kW (A3:4) F400 (°)	14/4,5	48,91	48,82	47.787,36	454,15	12,54	1420	1,00
HMF 112 T4/T6 14/4,5kW (A3:4) F400 (°)	14/4,5	50,77	50,76	45.167,47	447,36	11,30	1420	1,00
HMF 112 T4/T6 14/4,5kW (A3:4) F400 (°)	14/4,5	46,10	45,93	50.091,11	451,84	13,88	1420	1,00
HMF 112 T4/T6 14/4,5kW (A3:8) F400 (°)	14/4,5	57,78	57,60	40.666,11	670,97	14,07	1420	1,00
HMF 112 T4/T6 14/4,5kW (A3:8) F400 (°)	14/4,5	59,10	58,99	37.062,48	681,23	12,72	1420	1,00
HMF 112 T4/T6 14/4,5kW (A3:8) F400 (°)	14/4,5	59,52	59,49	33.497,64	695,11	11,64	1420	1,00
HMF 112 T4/T6 14/4,5kW (A3:8) F400 (°)	14/4,5	59,41	59,44	30.195,59	708	10,66	1420	1,00
HMF 112 T4/T6 16/6,5kW (A3:8) F400 (°)	16/6,5	55,48	55,15	47.984,32	657,81	16,90	1420	1,00
HMF 112 T4/T6 16/6,5kW (A3:8) F400 (°)	16/6,5	56,50	56,24	44.285,27	663,23	15,50	1420	1,00
HMF 112 T4/T6 20/8,5kW (A3:8) F400 (°)	20/8,5	53,40	52,98	51.076,20	674,33	18,96	1420	1,00
HMF 112 T4/T6 26/9kW (A3:8) F400 (°)	26/9	51,62	51,12	54.223,31	690,24	21,10	1420	1,00
HMF 112 T4/T6 26/9kW (A3:8) F400 (°)	26/9	48,48	47,85	59.738,16	701,78	24,86	1420	1,00
HMF 112 T4/T6 26/9kW (A3:8) F400 (°)	26/9	49,77	49,20	57.042,61	699,22	23,14	1420	1,00
HMF 112 T4/T6 34/12kW (A3:8) F400 (°)	34/12	46,45	45,76	62.509,16	704,62	27,06	1420	1,00
HMF 125 T4/T6 10/3,3kW (A3:4) F400 (°)	10/3,3	58,21	58,24	38.867,01	544,20	10,72	1420	1,00
HMF 125 T4/T6 10/3,3kW (A3:4) F400 (°)	10/3,3	59,70	59,89	34.627,57	555,89	9,43	1420	1,00
HMF 125 T4/T6 14/4,5kW (A3:4) F400 (°)	14/4,5	55,99	55,85	47.908,39	532,86	13,44	1420	1,00
HMF 125 T4/T6 14/4,5kW (A3:4) F400 (°)	14/4,5	57,13	57,08	43.235,32	536,37	12,01	1420	1,00
HMF 125 T4/T6 16/6,5kW (A3:4) F400 (°)	16/6,5	54,41	54,17	52.641,94	533,79	15,06	1420	1,00
HMF 125 T4/T6 16/6,5kW (A3:4) F400 (°)	16/6,5	53,14	52,83	57.616,06	538,43	16,65	1420	1,00
HMF 125 T4/T6 20/8,5kW (A3:4) F400 (°)	20/8,5	49,42	48,94	64.631,14	554,34	20,49	1420	1,00
HMF 125 T4/T6 20/8,5kW (A3:4) F400 (°)	20/8,5	51,38	50,99	60.950,03	546,90	18,40	1420	1,00
HMF 125 T4/T6 20/8,5kW (A3:8) F400 (°)	20/8,5	59,65	59,16	50.101,18	832,37	20,84	1420	1,00
HMF 125 T4/T6 20/8,5kW (A3:8) F400 (°)	20/8,5	60,33	59,91	45.513,87	844,37	18,92	1420	1,00
HMF 125 T4/T6 20/8,5kW (A3:8) F400 (°)	20/8,5	60,17	59,82	40.816,50	865,45	17,39	1420	1,00
HMF 125 T4/T6 26/9kW (A3:8) F400 (°)	26/9	55,98	55,28	64.842,17	805,03	27,60	1420	1,00
HMF 125 T4/T6 26/9kW (A3:8) F400 (°)	26/9	57,49	56,85	59.887,35	810,69	25,16	1420	1,00
HMF 125 T4/T6 26/9kW (A3:8) F400 (°)	26/9	58,26	57,69	54.888,01	820,52	23,04	1420	1,00
HMF 125 T4/T6 34/12kW (A3:4) F400 (°)	34/12	40,98	40,28	74.072,93	522,83	27,16	1420	1,00
HMF 125 T4/T6 34/12kW (A3:8) F400 (°)	34/12	52,01	51,13	73.025,87	843,98	34,43	1420	1,00
HMF 125 T4/T6 34/12kW (A3:8) F400 (°)	34/12	53,89	53,09	68.709,09	827,35	30,96	1420	1,00
HMF 125 T4/T6 40/14kW (A3:8) F400 (°)	40/14	48,98	47,97	80.875,45	856,90	40,79	1420	1,00
HMF 125 T4/T6 40/14kW (A3:8) F400 (°)	40/14	50,51	49,55	77.349,10	853,45	37,87	1420	1,00

ERP / 4/8 poles

Model	Motor power (kW)	Maximum efficiency point data						
		Max. efficiency (%)	Efficiency grade (N) (N)	Air Flow (m3/h)	Ps (Pa)	Pabs (kW)	speed (rpm)	Specific ratio
HMF 45 T4/T8 0,8/0,2kW (A5:6) F400 (°)	0,8/0,2	25,22	34,25	3.938,40	91,48	0,37	1500	1,00
HMF 50 T4/T8 0,8/0,2kW (A5:6) F400 (°)	0,8/0,2	33,75	41,93	5.631,13	108,38	0,51	1500	1,00
HMF 56 T4/T8 0,8/0,2kW (A5:6) F400 (°)	0,8/0,2	38,49	46,08	5.286,46	156,65	0,63	1500	1,00
HMF 56 T4/T8 0,8/0,2kW (A5:6) F400 (°)	0,8/0,2	38,91	45,71	6.799,71	163,76	0,84	1500	1,00
HMF 56 T4/T8 0,8/0,2kW (A5:6) F400 (°)	0,8/0,2	40,36	47,48	6.377,29	162,70	0,75	1500	1,00
HMF 56 T4/T8 1,2/0,3kW (A5:6) F400 (°)	1,2/0,3	35,94	41,99	7.864,11	175,27	1,11	1500	1,00
HMF 56 T4/T8 1,2/0,3kW (A5:6) F400 (°)	1,2/0,3	37,33	43,85	7.198,19	163,79	0,93	1500	1,00
HMF 56 T4/T8 1,6/0,4kW (A5:6) F400 (°)	1,6/0,4	35,35	41	8.575,19	185,04	1,28	1500	1,00
HMF 56 T4/T8 1,6/0,4kW (A5:6) F400 (°)	1,6/0,4	35,43	40,72	9.299,95	193,09	1,46	1500	1,00
HMF 63 T4/T8 0,8/0,2kW (A5:6) F400 (°)	0,8/0,2	46,63	53,25	7.384,78	192,08	0,90	1500	1,00
HMF 63 T4/T8 1,2/0,3kW (A5:6) F400 (°)	1,2/0,3	46,52	52,17	9.056,31	221,36	1,28	1500	1,00
HMF 63 T4/T8 1,6/0,4kW (A5:6) F400 (°)	1,6/0,4	42,12	47,20	10.066,20	229,21	1,58	1500	1,00
HMF 63 T4/T8 1,6/0,4kW (A5:6) F400 (°)	1,6/0,4	44,39	49,74	9.588,71	224,77	1,43	1500	1,00
HMF 63 T4/T8 2,2/0,37kW (A5:6) F400 (°)	2,2/0,37	38,35	42,73	11.588,88	230,37	2,03	1500	1,00
HMF 63 T4/T8 2,2/0,37kW (A5:6) F400 (°)	2,2/0,37	40,03	44,74	10.830,65	229,31	1,81	1500	1,00
HMF 71 T4/T8 0,8/0,2kW (A5:6) F400 (°)	0,8/0,2	47,01	53,39	7.908,74	201,69	0,98	1500	1,00
HMF 71 T4/T8 1,2/0,3kW (A5:6) F400 (°)	1,2/0,3	45,67	51,11	9.865,86	221,15	1,39	1500	1,00
HMF 71 T4/T8 1,6/0,4kW (A5:6) F400 (°)	1,6/0,4	46,22	50,95	11.855,32	240,58	1,80	1500	1,00
HMF 71 T4/T8 2,2/0,37kW (A5:6) F400 (°)	2,2/0,37	42,32	46,19	14.007,05	256,86	2,46	1500	1,00
HMF 71 T4/T8 2,2/0,37kW (A5:6) F400 (°)	2,2/0,37	43,85	48,11	12.922	248,26	2,13	1500	1,00
HMF 71 T4/T8 3/0,55kW (A5:6) F400 (°)	3/0,55	39,37	42,79	15.295,05	255,96	2,89	1500	1,00
HMF 71 T4/T8 3/0,55kW (A5:6) F400 (°)	3/0,55	40,72	44,36	14.637,66	255,51	2,67	1500	1,00
HMF 80 T4/T8 3/0,55kW (A5:6) F400 (°)	3/0,55	47,47	50,44	18.603,39	298,09	3,41	1500	1,00
HMF 80 T4/T8 3/0,55kW (A5:6) F400 (°)	3/0,55	49,89	53,19	17.421,07	297,07	3,02	1500	1,00
HMF 80 T4/T8 3/0,55kW (A5:6) F400 (°)	3/0,55	53,27	56,95	16.269,95	295,38	2,63	1500	1,00
HMF 80 T4/T8 4/0,75kW (A5:6) F400 (°)	4/0,75	46,01	48,67	20.008,80	305,30	3,81	1500	1,00
HMF 80 T4/T8 4/0,75kW (A5:6) F400 (°)	4/0,75	45,44	47,83	21.569,23	310,17	4,22	1500	1,00
HMF 90 T4/T8 2,8/0,7kW (A3:4) F400 (°)	2,8/0,7	48,40	51,64	16.269,79	312,06	3,09	1420	1,00
HMF 90 T4/T8 2,8/0,7kW (A3:4) F400 (°)	2,8/0,7	49,88	53,58	14.806,82	298,15	2,61	1420	1,00
HMF 90 T4/T8 4/0,75kW (A3:4) F400 (°)	4/0,75	46,06	48,49	19.259,13	340,14	4,15	1420	1,00
HMF 90 T4/T8 4/0,75kW (A3:4) F400 (°)	4/0,75	47,50	50,34	17.768,06	326,89	3,58	1420	1,00
HMF 90 T4/T8 5,5/1,1kW (A3:4) F400 (°)	5,5/1,1	43,92	45,63	22.345,93	367,81	5,41	1420	1,00
HMF 90 T4/T8 5,5/1,1kW (A3:4) F400 (°)	5,5/1,1	45,22	47,29	20.822,29	353,92	4,73	1420	1,00
HMF 90 T4/T8 5,5/1,1kW (A3:4) F400 (°)	5,5/1,1	42,44	43,93	23.455,15	367,14	5,86	1420	1,00
HMF 90 T4/T8 5,5/1,1kW (A3:8) F400 (°)	5,5/1,1	47,68	49,45	17.497,66	461,40	5,27	1420	1,00
HMF 90 T4/T8 5,5/1,1kW (A3:8) F400 (°)	5,5/1,1	48,67	50,84	15.786,74	450,04	4,57	1420	1,00



Model	Motor power (kW)	Maximum efficiency point data						
		Max. efficiency (%)	Efficiency grade (N) (N)	Air Flow (m3/h)	Ps (Pa)	Pabs (kW)	speed (rpm)	Specific ratio
HMF 90 T4/T8 7,5/1,5kW (A3:4) F400 (°)	7,5/1,5	41,38	42,67	24.607,17	366,35	6,30	1420	1,00
HMF 90 T4/T8 7,5/1,5kW (A3:4) F400 (°)	7,5/1,5	37,31	38,09	27.009,72	360,41	7,58	1420	1,00
HMF 90 T4/T8 7,5/1,5kW (A3:4) F400 (°)	7,5/1,5	39,50	40,55	25.787,41	364,05	6,88	1420	1,00
HMF 90 T4/T8 7,5/1,5kW (A3:4) F400 (°)	7,5/1,5	42,44	43,93	23.455,15	367,14	5,86	1420	1,00
HMF 90 T4/T8 7,5/1,5kW (A3:8) F400 (°)	7,5/1,5	45,05	45,76	22.907,92	496,52	7,76	1420	1,00
HMF 90 T4/T8 7,5/1,5kW (A3:8) F400 (°)	7,5/1,5	46,06	47,13	21.070,55	483,55	6,84	1420	1,00
HMF 90 T4/T8 7,5/1,5kW (A3:8) F400 (°)	7,5/1,5	46,56	47,96	19.242,52	472,46	6,05	1420	1,00
HMF 90 T4/T8 11/3kW (A3:4) F400 (°)	11/3	35,47	36,01	28.252,71	356,23	8,28	1420	1,00
HMF 90 T4/T8 11/3kW (A3:8) F400 (°)	11/3	40,70	40,69	29.199,51	527,28	11,30	1420	1,00
HMF 90 T4/T8 11/3kW (A3:8) F400 (°)	11/3	41,82	41,88	27.753,29	520,19	10,39	1420	1,00
HMF 90 T4/T8 11/3kW (A3:8) F400 (°)	11/3	43,24	43,40	26.309,90	515,21	9,50	1420	1,00
HMF 90 T4/T8 11/3kW (A3:8) F400 (°)	11/3	44,52	44,93	24.798,94	510,53	8,67	1420	1,00
HMF 90 T4/T8 14/3,5kW (A3:8) F400 (°)	14/3,5	38,50	38,36	32.064,08	543,37	13,28	1420	1,00
HMF 90 T4/T8 14/3,5kW (A3:8) F400 (°)	14/3,5	39,99	39,92	30.693,75	535,39	12,16	1420	1,00
HMF 100 T4/T8 5,5/1,1kW (A3:4) F400 (°)	5,5/1,1	51,87	53,30	26.551,96	401	5,98	1420	1,00
HMF 100 T4/T8 5,5/1,1kW (A3:4) F400 (°)	5,5/1,1	53,50	55,28	24.581,71	393,08	5,28	1420	1,00
HMF 100 T4/T8 5,5/1,1kW (A3:4) F400 (°)	5,5/1,1	55,29	57,42	22.619,79	386,25	4,64	1420	1,00
HMF 100 T4/T8 5,5/1,1kW (A3:4) F400 (°)	5,5/1,1	56,41	58,86	20.842,55	377,22	4,11	1420	1,00
HMF 100 T4/T8 7,5/1,5kW (A3:4) F400 (°)	7,5/1,5	49,06	49,88	30.676,32	415,55	7,49	1420	1,00
HMF 100 T4/T8 7,5/1,5kW (A3:4) F400 (°)	7,5/1,5	50,77	51,90	28.592,36	409,27	6,67	1420	1,00
HMF 100 T4/T8 7,5/1,5kW (A3:8) F400 (°)	7,5/1,5	55,47	56,16	23.417,68	607,83	7,82	1420	1,00
HMF 100 T4/T8 11/3kW (A3:4) F400 (°)	11/3	41,52	41,52	37.883,88	424,19	11,15	1420	1,00
HMF 100 T4/T8 11/3kW (A3:4) F400 (°)	11/3	43,81	43,89	35.974,38	428,43	10,10	1420	1,00
HMF 100 T4/T8 11/3kW (A3:4) F400 (°)	11/3	45,92	46,20	34.144,20	427,62	9,11	1420	1,00
HMF 100 T4/T8 11/3kW (A3:4) F400 (°)	11/3	47,76	48,32	32.382,92	421,97	8,22	1420	1,00
HMF 100 T4/T8 11/3kW (A3:8) F400 (°)	11/3	51,03	51,01	31.641,86	617,34	11,55	1420	1,00
HMF 100 T4/T8 11/3kW (A3:8) F400 (°)	11/3	53,94	54,11	27.456,87	612,59	9,47	1420	1,00
HMF 100 T4/T8 11/3kW (A3:8) F400 (°)	11/3	55,20	55,65	25.420,36	610,20	8,56	1420	1,00
HMF 100 T4/T8 11/3kW (A3:8) F400 (°)	11/3	52,54	52,58	29.528,86	615,77	10,48	1420	1,00
HMF 100 T4/T8 14/3,5kW (A3:4) F400 (°)	14/3,5	39,45	39,38	39.773,65	420,72	12,24	1420	1,00
HMF 100 T4/T8 14/3,5kW (A3:8) F400 (°)	14/3,5	48,58	48,41	35.858,39	631,14	13,92	1420	1,00
HMF 100 T4/T8 14/3,5kW (A3:8) F400 (°)	14/3,5	50,05	49,95	33.667,23	620,57	12,57	1420	1,00
HMF 100 T4/T8 17/4,3kW (A3:8) F400 (°)	17/4,3	45,47	45,14	40.435,64	650,15	17,04	1420	1,00
HMF 100 T4/T8 17/4,3kW (A3:8) F400 (°)	17/4,3	47,09	46,83	38.099,12	641,83	15,45	1420	1,00
HMF 100 T4/T8 20/5kW (A3:8) F400 (°)	20/5	43,92	43,51	42.881,99	657,50	18,71	1420	1,00
HMF 100 T4/T8 20/5kW (A3:8) F400 (°)	20/5	42,42	41,94	45.506,86	663,64	20,54	1420	1,00
HMF 112 T4/T8 5,5/1,1kW (A3:4) F400 (°)	5,5/1,1	58,57	60,07	25.650,99	454,24	5,82	1420	1,00
HMF 112 T4/T8 7,5/1,5kW (A3:4) F400 (°)	7,5/1,5	57,62	58,79	28.722,21	445,68	6,56	1420	1,00



Model	Motor power (kW)	Maximum efficiency point data						
		Max. efficiency (%)	Efficiency grade (N) (N)	Air Flow (m3/h)	Ps (Pa)	Pabs (kW)	speed (rpm)	Specific ratio
HMF 112 T4/T8 7,5/1,5kW (A3:4) F400 (°)	7,5/1,5	56,18	57,03	31.958,45	439,65	7,40	1420	1,00
HMF 112 T4/T8 11/3kW (A3:4) F400 (°)	11/3	50,77	50,76	45.167,47	447,36	11,30	1420	1,00
HMF 112 T4/T8 11/3kW (A3:4) F400 (°)	11/3	52,52	52,59	42.650,78	440,51	10,20	1420	1,00
HMF 112 T4/T8 11/3kW (A3:4) F400 (°)	11/3	54,03	54,29	38.950,75	437	9,18	1420	1,00
HMF 112 T4/T8 11/3kW (A3:4) F400 (°)	11/3	55,47	56,03	35.408,75	436,25	8,21	1420	1,00
HMF 112 T4/T8 11/3kW (A3:8) F400 (°)	11/3	59,41	59,44	30.195,59	708	10,66	1420	1,00
HMF 112 T4/T8 14/3,5kW (A3:4) F400 (°)	14/3,5	48,91	48,82	47.787,36	454,15	12,54	1420	1,00
HMF 112 T4/T8 14/3,5kW (A3:4) F400 (°)	14/3,5	46,10	45,93	50.091,11	451,84	13,88	1420	1,00
HMF 112 T4/T8 14/3,5kW (A3:8) F400 (°)	14/3,5	57,78	57,60	40.666,11	670,97	14,07	1420	1,00
HMF 112 T4/T8 14/3,5kW (A3:8) F400 (°)	14/3,5	59,10	58,99	37.062,48	681,23	12,72	1420	1,00
HMF 112 T4/T8 14/3,5kW (A3:8) F400 (°)	14/3,5	59,52	59,49	33.497,64	695,11	11,64	1420	1,00
HMF 112 T4/T8 17/4,3kW (A3:8) F400 (°)	17/4,3	55,48	55,15	47.984,32	657,81	16,90	1420	1,00
HMF 112 T4/T8 17/4,3kW (A3:8) F400 (°)	17/4,3	56,50	56,24	44.285,27	663,23	15,50	1420	1,00
HMF 112 T4/T8 20/5kW (A3:8) F400 (°)	20/5	53,40	52,98	51.076,20	674,33	18,96	1420	1,00
HMF 112 T4/T8 28/6,5kW (A3:8) F400 (°)	28/6,5	51,62	51,12	54.223,31	690,24	21,10	1420	1,00
HMF 112 T4/T8 28/6,5kW (A3:8) F400 (°)	28/6,5	46,45	45,76	62.509,16	704,62	27,06	1420	1,00
HMF 112 T4/T8 28/6,5kW (A3:8) F400 (°)	28/6,5	48,48	47,85	59.738,16	701,78	24,86	1420	1,00
HMF 112 T4/T8 28/6,5kW (A3:8) F400 (°)	28/6,5	49,77	49,20	57.042,61	699,22	23,14	1420	1,00
HMF 125 T4/T8 11/3kW (A3:4) F400 (°)	11/3	58,21	58,24	38.867,01	544,20	10,72	1420	1,00
HMF 125 T4/T8 11/3kW (A3:4) F400 (°)	11/3	59,70	59,89	34.627,57	555,89	9,43	1420	1,00
HMF 125 T4/T8 14/3,5kW (A3:4) F400 (°)	14/3,5	55,99	55,85	47.908,39	532,86	13,44	1420	1,00
HMF 125 T4/T8 14/3,5kW (A3:4) F400 (°)	14/3,5	57,13	57,08	43.235,32	536,37	12,01	1420	1,00
HMF 125 T4/T8 17/4,3kW (A3:4) F400 (°)	17/4,3	54,41	54,17	52.641,94	533,79	15,06	1420	1,00
HMF 125 T4/T8 17/4,3kW (A3:4) F400 (°)	17/4,3	53,14	52,83	57.616,06	538,43	16,65	1420	1,00
HMF 125 T4/T8 20/5kW (A3:4) F400 (°)	20/5	49,42	48,94	64.631,14	554,34	20,49	1420	1,00
HMF 125 T4/T8 20/5kW (A3:4) F400 (°)	20/5	51,38	50,99	60.950,03	546,90	18,40	1420	1,00
HMF 125 T4/T8 20/5kW (A3:8) F400 (°)	20/5	59,65	59,16	50.101,18	832,37	20,84	1420	1,00
HMF 125 T4/T8 20/5kW (A3:8) F400 (°)	20/5	60,33	59,91	45.513,87	844,37	18,92	1420	1,00
HMF 125 T4/T8 20/5kW (A3:8) F400 (°)	20/5	60,17	59,82	40.816,50	865,45	17,39	1420	1,00
HMF 125 T4/T8 28/6,5kW (A3:8) F400 (°)	28/6,5	55,98	55,28	64.842,17	805,03	27,60	1420	1,00
HMF 125 T4/T8 28/6,5kW (A3:8) F400 (°)	28/6,5	57,49	56,85	59.887,35	810,69	25,16	1420	1,00
HMF 125 T4/T8 28/6,5kW (A3:8) F400 (°)	28/6,5	58,26	57,69	54.888,01	820,52	23,04	1420	1,00
HMF 125 T4/T8 37/9,2kW (A3:8) F400 (°)	37/9,2	50,51	49,55	77.349,10	853,45	37,87	1420	1,00
HMF 125 T4/T8 37/9,2kW (A3:8) F400 (°)	37/9,2	52,01	51,13	73.025,87	843,98	34,43	1420	1,00
HMF 125 T4/T8 37/9,2kW (A3:8) F400 (°)	37/9,2	53,89	53,09	68.709,09	827,35	30,96	1420	1,00
HMF 125 T4/T8 44/11kW (A3:8) F400 (°)	44/11	46,52	45,44	84.191,86	861,51	44,34	1420	1,00
HMF 125 T4/T8 44/11kW (A3:8) F400 (°)	44/11	48,98	47,97	80.875,45	856,90	40,79	1420	1,00