

HCF F400



SHORT CASED AXIAL FAN

MANUFACTURING FEATURES:

- Axial fan short casing with circular reinforced frame.
- Modular motor-impeller assembly. Cast aluminium impeller with variable pitch angle. Epoxy powder finishing coat.
- Standard asynchronous squirrel-cage motor with IP-55 protection and Class H insulation certified 400°C/2h. Manufactured with standard voltages: 230/400V 50Hz in three phase motors up to 4kW and 400/690V 50Hz for higher powers.

APPLICATIONS:

Designed for inline installation, they are suitable for:

- Smoke emergency exhaust with motor inside the hazardous area.
- Maximum working temperature: 60°C.

UNDER REQUEST:

- Supply impeller (air direction from impeller to motor).
- 100% reversible impeller.

Official homologation by the European laboratory APPLUS according to EN 12101-3:2002, EN 12101-3:2002/AC:2005
 Certification Nr: 0370-CPR-0912

Accessories



AC



BAD



CPM



INT



INT 400



PO



RP



RP1



SFC



SIL-C /
SIL-CN

Technical data

Three-phase motor / 4 poles

Code	Model	R.P.M.	Rated I. (A) 400V	Rated power kW	Max. Airflow m3/h	Sound db (A)*	Weight	Connect. diagram
26247606__AF	HCF 45 T4 0,75kW (A5:6) F400	1404	1,95	0,75	6.650	50	24	1
26250606__AF	HCF 50 T4 0,75kW (A5:6) F400	1404	1,95	0,75	8.760	52	33	1
26258656__AF	HCF 56 T4 0,75kW (A5:6) F400	1404	1,95	0,75	10.270	57	63	1
26260656__AF	HCF 56 T4 1,1kW (A5:6) F400	1392	2,7	1,10	11.890	56	68	1
26261656__AF	HCF 56 T4 1,5kW (A5:6) F400	1410	3,6	1,50	13.870	57	69	1
26265656__AF	HCF 63 T4 0,75kW (A5:6) F400	1404	1,95	0,75	11.420	60	60	1
26266656__AF	HCF 63 T4 1,1kW (A5:6) F400	1392	2,7	1,10	14.010	61	65	1
26267656__AF	HCF 63 T4 1,5kW (A5:6) F400	1410	3,6	1,50	15.780	57	66	1
26268656__AF	HCF 63 T4 2,2kW (A5:6) F400	1420	4,55	2,20	17.690	58	72	1
26272656__AF	HCF 71 T4 0,75kW (A5:6) F400	1404	1,95	0,75	12.950	65	71	1
26273656__AF	HCF 71 T4 1,1kW (A5:6) F400	1392	2,7	1,10	15.960	64	73	1
26274656__AF	HCF 71 T4 1,5kW (A5:6) F400	1410	3,6	1,50	18.960	63	74	1
26275656__AF	HCF 71 T4 2,2kW (A5:6) F400	1420	4,55	2,20	22.040	61	76	1
26276656__AF	HCF 71 T4 3kW (A5:6) F400	1420	6,12	3	23.900	63	79	1
26284656__AF	HCF 80 T4 3kW (A5:6) F400	1420	6,12	3	28.540	63	88	1
26285656__AF	HCF 80 T4 4kW (A5:6) F400	1428	8,57	4	32.300	64	101	1
26293634__AF	HCF 90 T4 3kW (A3:4) F400	1420	6,12	3	27.600	66	101	1
26294634__AF	HCF 90 T4 4kW (A3:4) F400	1428	8,57	4	32.700	65	114	1
26295634__AF	HCF 90 T4 5,5kW (A3:4) F400	1450	10,5	5,50	39.500	63	127	1
26295638__AF	HCF 90 T4 5,5kW (A3:8) F400	1450	10,5	5,50	32.000	70	131	1
26296634__AF	HCF 90 T4 7,5kW (A3:4) F400	1453	14,1	7,50	44.600	63	141	1
26296638__AF	HCF 90 T4 7,5kW (A3:8) F400	1453	14,1	7,50	37.100	68	145	1
26297634__AF	HCF 90 T4 11kW (A3:4) F400	1470	21,2	11	46.300	65	171	1
26297638__AF	HCF 90 T4 11kW (A3:8) F400	1470	21,2	11	47.600	66	172	1
26298638__AF	HCF 90 T4 15kW (A3:8) F400	1465	28,7	15	52.600	66	200	1
26214634__AF	HCF 100 T4 5,5kW (A3:4) F400	1450	10,5	5,50	45.600	71	139	1
26215634__AF	HCF 100 T4 7,5kW (A3:4) F400	1453	14,1	7,50	51.400	71	153	1
26215638__AF	HCF 100 T4 7,5kW (A3:8) F400	1453	14,1	7,50	39.400	81	156	1
26216634__AF	HCF 100 T4 11kW (A3:4) F400	1470	21,2	11	62.300	70	180	1
26216638__AF	HCF 100 T4 11kW (A3:8) F400	1470	21,2	11	52.500	76	183	1
26217634__AF	HCF 100 T4 15kW (A3:4) F400	1465	28,7	15	65.200	71	208	1
26217638__AF	HCF 100 T4 15kW (A3:8) F400	1465	28,7	15	63.600	73	211	1
26218638__AF	HCF 100 T4 18,5kW (A3:8) F400	1465	35,1	18,50	71.300	73	259	1
26219638__AF	HCF 100 T4 22kW (A3:8) F400	1465	40,5	22	75.100	74	260	1
26223634__AF	HCF 112 T4 5,5kW (A3:4) F400	1450	10,5	5,50	50.600	75	170	1

Code	Model	R.P.M.	Rated I. (A) 400V	Rated power kW	Max. Airflow m3/h	Sound db (A)*	Weight	Connect. diagram
26224634__AF	HCF 112 T4 7,5kW (A3:4) F400	1453	14,1	7,50	59.100	75	176	1
26225634__AF	HCF 112 T4 11kW (A3:4) F400	1470	21,2	11	75.500	72	200	1
26225638__AF	HCF 112 T4 11kW (A3:8) F400	1470	21,2	11	57.600	81	203	1
26226634__AF	HCF 112 T4 15kW (A3:4) F400	1465	28,7	15	86.200	72	225	1
26226638__AF	HCF 112 T4 15kW (A3:8) F400	1465	28,7	15	72.400	79	229	1
26227634__AF	HCF 112 T4 18,5kW (A3:4) F400	1465	35,1	18,50	89.500	73	268	1
26227638__AF	HCF 112 T4 18,5kW (A3:8) F400	1465	35,1	18,50	82.400	77	272	1
26228638__AF	HCF 112 T4 22kW (A3:8) F400	1465	40,5	22	91.800	75	273	1
26229638__AF	HCF 112 T4 30kW (A3:8) F400	1470	56,2	30	99.700	75	327	1
27206634__AF	HCF 125 T4 11kW (A3:4) F400	1470	21,2	11	74.100	83	209	1
27207634__AF	HCF 125 T4 15kW (A3:4) F400	1465	28,7	15	91.200	78	237	1
27208634__AF	HCF 125 T4 18,5kW (A3:4) F400	1465	35,1	18,50	102.000	76	285	1
27208638__AF	HCF 125 T4 18,5kW (A3:8) F400	1465	35,1	18,50	77.800	88	293	1
27209634__AF	HCF 125 T4 22kW (A3:4) F400	1465	40,5	22	112.000	75	286	1
27209638__AF	HCF 125 T4 22kW (A3:8) F400	1465	40,5	22	91.200	85	294	1
27210634__AF	HCF 125 T4 30kW (A3:4) F400	1470	56,2	30	121.000	75	346	1
27210638__AF	HCF 125 T4 30kW (A3:8) F400	1470	56,2	30	111.000	81	354	1
27211638__AF	HCF 125 T4 37kW (A3:8) F400	1475	66,6	37	124.000	78	455	1
27212638__AF	HCF 125 T4 45kW (A3:8) F400	1475	80,7	45	135.000	77	500	1

Three-phase motor / 6 poles

Code	Model	R.P.M.	Rated I. (A) 400V	Rated power kW	Max. Airflow m3/h	Sound db (A)*	Weight	Connect. diagram
26251606__AF	HCF 50 T6 0,75kW (A5:6) F400	923	2,2	0,75	6.000	43	30	1
26258656__AF	HCF 56 T6 0,75kW (A5:6) F400	923	2,2	0,75	8.330	48	62	1
26264656__AF	HCF 63 T6 0,75kW (A5:6) F400	923	2,2	0,75	11.450	50	58	1
26272656__AF	HCF 71 T6 0,75kW (A5:6) F400	923	2,2	0,75	15.440	53	67	1
26280656__AF	HCF 80 T6 0,75kW (A5:6) F400	923	2,2	0,75	17.380	59	74	1
26281656__AF	HCF 80 T6 1,1kW (A5:6) F400	920	3,1	1,10	19.520	55	78	1
26282656__AF	HCF 80 T6 1,5kW (A5:6) F400	933	3,6	1,50	21.820	55	84	1
26283656__AF	HCF 80 T6 2,2kW (A5:6) F400	948	5,23	2,20	23.930	56	93	1
26291634__AF	HCF 90 T6 1,5kW (A3:4) F400	933	3,6	1,50	25.600	54	97	1
26291638__AF	HCF 90 T6 1,5kW (A3:8) F400	933	3,6	1,50	20.700	60	101	1
26292634__AF	HCF 90 T6 2,2kW (A3:4) F400	948	5,23	2,20	30.000	54	106	1
26292638__AF	HCF 90 T6 2,2kW (A3:8) F400	948	5,23	2,20	25.700	58	109	1
26293638__AF	HCF 90 T6 3kW (A3:8) F400	965	7,42	3	30.800	57	133	1
26294638__AF	HCF 90 T6 4kW (A3:8) F400	963	8,97	4	34.100	57	139	1

Code	Model	R.P.M.	Rated I. (A) 400V	Rated power kW	Max. Airflow m3/h	Sound db (A)*	Weight	Connect. diagram
26210634__AF	HCF 100 T6 1,5kW (A3:4) F400	933	3,6	1,50	29.600	62	108	1
26211634__AF	HCF 100 T6 2,2kW (A3:4) F400	948	5,23	2,20	35.000	61	117	1
26211638__AF	HCF 100 T6 2,2kW (A3:8) F400	948	5,23	2,20	27.600	70	119	1
26212634__AF	HCF 100 T6 3kW (A3:4) F400	965	7,42	3	40.400	60	141	1
26212638__AF	HCF 100 T6 3kW (A3:8) F400	965	7,42	3	34.000	66	145	1
26213634__AF	HCF 100 T6 4kW (A3:4) F400	963	8,97	4	42.200	61	147	1
26213638__AF	HCF 100 T6 4kW (A3:8) F400	963	8,97	4	41.200	63	151	1
26214638__AF	HCF 100 T6 5,5kW (A3:8) F400	960	12,8	5,50	48.600	63	155	1
26220634__AF	HCF 112 T6 2,2kW (A3:4) F400	948	5,23	2,20	41.000	64	147	1
26221634__AF	HCF 112 T6 3kW (A3:4) F400	965	7,42	3	48.900	63	168	1
26221638__AF	HCF 112 T6 3kW (A3:8) F400	965	7,42	3	37.300	72	170	1
26222634__AF	HCF 112 T6 4kW (A3:4) F400	963	8,97	4	55.900	62	174	1
26222638__AF	HCF 112 T6 4kW (A3:8) F400	963	8,97	4	46.900	69	174	1
26223634__AF	HCF 112 T6 5,5kW (A3:4) F400	960	12,8	5,50	58.000	63	177	1
26223638__AF	HCF 112 T6 5,5kW (A3:8) F400	960	12,8	5,50	56.600	66	184	1
26224638__AF	HCF 112 T6 7,5kW (A3:8) F400	970	15	7,50	64.600	65	223	1
27202634__AF	HCF 125 T6 3kW (A3:4) F400	965	7,42	3	51.700	72	174	1
27203634__AF	HCF 125 T6 4kW (A3:4) F400	963	8,97	4	59.100	68	180	1
27204634__AF	HCF 125 T6 5,5kW (A3:4) F400	960	12,8	5,50	69.400	65	184	1
27204638__AF	HCF 125 T6 5,5kW (A3:8) F400	960	12,8	5,50	54.800	77	195	1
27205634__AF	HCF 125 T6 7,5kW (A3:4) F400	970	15	7,50	78.400	65	228	1
27205638__AF	HCF 125 T6 7,5kW (A3:8) F400	970	15	7,50	67.700	72	239	1
27206638__AF	HCF 125 T6 11kW (A3:8) F400	970	22	11	83.800	68	259	1
27207638__AF	HCF 125 T6 15kW (A3:8) F400	970	27,9	15	87.200	67	297	1

2 SPEED MOTOR / 4/8 poles

Code	Model	R.P.M.	Rated I. (A) 400V	Rated power kW	Max. Airflow m3/h	Sound db (A)*	Weight	Connect. diagram
26247606__AW	HCF 45 T4/T8 0,8/0,2kW (A5:6) F400	1430	2/0,89	0.8/0.2	6.650	35	24	2
26250606__AW	HCF 50 T4/T8 0,8/0,2kW (A5:6) F400	1430	2/0,89	0.8/0.2	8.760	37	33	2
26259656__AW	HCF 56 T4/T8 0,8/0,2kW (A5:6) F400	1430	2/0,89	0.8/0.2	10.270	42	62	2
26260656__AW	HCF 56 T4/T8 1,2/0,3kW (A5:6) F400	1410	2,92/1,29	1.2/0.3	11.890	40	68	2
26261656__AW	HCF 56 T4/T8 1,6/0,4kW (A5:6) F400	1440	3,8/1,69	1.6/0.4	13.870	42	69	2
26265656__AW	HCF 63 T4/T8 0,8/0,2kW (A5:6) F400	1430	2/0,89	0.8/0.2	11.420	45	60	2
26266656__AW	HCF 63 T4/T8 1,2/0,3kW (A5:6) F400	1410	2,92/1,29	1.2/0.3	14.010	46	65	2
26267656__AW	HCF 63 T4/T8 1,6/0,4kW (A5:6) F400	1440	3,8/1,69	1.6/0.4	15.780	42	66	2
26268656__AW	HCF 63 T4/T8 2,2/0,37kW (A5:6) F400	1440	4,84/2	2.2/0.37	17.690	43	72	2

Code	Model	R.P.M.	Rated I. (A) 400V	Rated power kW	Max. Airflow m3/h	Sound db (A)*	Weight	Connect. diagram
26272656__AW	HCF 71 T4/T8 0,8/0,2kW (A5:6) F400	1430	2/0,89	0.8/0.2	12.950	50	71	2
26273656__AW	HCF 71 T4/T8 1,2/0,3kW (A5:6) F400	1410	2,92/1,29	1.2/0.3	15.960	49	73	2
26274656__AW	HCF 71 T4/T8 1,6/0,4kW (A5:6) F400	1440	3,8/1,69	1.6/0.4	18.960	48	74	2
26275656__AW	HCF 71 T4/T8 2,2/0,37kW (A5:6) F400	1440	4,84/2	2.2/0.37	22.040	46	76	2
26276656__AW	HCF 71 T4/T8 3/0,55kW (A5:6) F400	1428	7,1/5,1	3/0.55	23.900	48	79	2
26284656__AW	HCF 80 T4/T8 3/0,55kW (A5:6) F400	1428	7,1/5,1	3/0.55	28.540	48	88	2
26285656__AW	HCF 80 T4/T8 4/0,75kW (A5:6) F400	1430	8,6/2,6	4/0.75	32.300	49	101	2
26293634__AW	HCF 90 T4/T8 2,8/0,7kW (A3:4) F400	1440	6/2,4	2.8/0.7	27.600	50	107	2
26294634__AW	HCF 90 T4/T8 4/0,75kW (A3:4) F400	1430	8,6/2,6	4/0.75	32.700	49	114	2
26295634__AW	HCF 90 T4/T8 5,5/1,1kW (A3:4) F400	1454	10,9/3,32	5.5/1.1	39.500	47	127	2
26295638__AW	HCF 90 T4/T8 5,5/1,1kW (A3:8) F400	1454	10,9/3,32	5.5/1.1	29.400	55	131	2
26296634__AW	HCF 90 T4/T8 7,5/1,5kW (A3:4) F400	1461	14,9/3,7	7.5/1.5	44.600	47	141	2
26296638__AW	HCF 90 T4/T8 7,5/1,5kW (A3:8) F400	1461	14,9/3,7	7.5/1.5	37.100	53	145	2
26297634__AW	HCF 90 T4/T8 11/3kW (A3:4) F400	1455	21,7/7	11/3	46.300	49	171	2
26297638__AW	HCF 90 T4/T8 11/3kW (A3:8) F400	1455	21,7/7	11/3	47.600	50	172	2
26298638__AW	HCF 90 T4/T8 14/3,5kW (A3:8) F400	1450	26,5/8,45	14/3.5	52.600	51	202	2
26214634__AW	HCF 100 T4/T8 5,5/1,1kW (A3:4) F400	1454	10,9/3,32	5.5/1.1	45.600	56	139	2
26215634__AW	HCF 100 T4/T8 7,5/1,5kW (A3:4) F400	1461	14,9/3,7	7.5/1.5	51.400	55	153	2
26215638__AW	HCF 100 T4/T8 7,5/1,5kW (A3:8) F400	1461	14,9/3,7	7.5/1.5	39.400	65	156	2
26216634__AW	HCF 100 T4/T8 11/3kW (A3:4) F400	1455	21,7/7	11/3	62.300	54	180	2
26216638__AW	HCF 100 T4/T8 11/3kW (A3:8) F400	1455	21,7/7	11/3	52.500	60	183	2
26217634__AW	HCF 100 T4/T8 14/3,5kW (A3:4) F400	1450	26,5/8,45	14/3.5	65.200	55	186	2
26217638__AW	HCF 100 T4/T8 14/3,5kW (A3:8) F400	1450	26,5/8,45	14/3.5	59.700	58	189	2
26218638__AW	HCF 100 T4/T8 17/4,3kW (A3:8) F400	1475	33,4/12,7	17/4.3	67.500	57	201	2
26219638__AW	HCF 100 T4/T8 20/5kW (A3:8) F400	1470	38,6/14,1	20/5	75.100	57	211	2
26223634__AW	HCF 112 T4/T8 5,5/1,1kW (A3:4) F400	1454	10,9/3,32	5.5/1.1	50.600	59	160	2
26224634__AW	HCF 112 T4/T8 7,5/1,5kW (A3:4) F400	1461	14,9/3,7	7.5/1.5	59.100	59	176	2
26225634__AW	HCF 112 T4/T8 11/3kW (A3:4) F400	1455	21,7/7	11/3	75.500	56	200	2
26225638__AW	HCF 112 T4/T8 11/3kW (A3:8) F400	1455	21,7/7	11/3	52.700	67	203	2
26226634__AW	HCF 112 T4/T8 14/3,5kW (A3:4) F400	1450	26,5/8,45	14/3.5	82.900	56	210	2
26226638__AW	HCF 112 T4/T8 14/3,5kW (A3:8) F400	1450	26,5/8,45	14/3.5	67.500	64	213	2
26226634__AW	HCF 112 T4/T8 17/4,3kW (A3:4) F400	1475	33,4/12,7	17/4.3	89.500	56	205	2
26226638__AW	HCF 112 T4/T8 17/4,3kW (A3:8) F400	1475	33,4/12,7	17/4.3	77.400	62	209	2
26228638__AW	HCF 112 T4/T8 20/5kW (A3:8) F400	1470	38,6/14,1	20/5	82.400	61	229	2
26228638__AW	HCF 112 T4/T8 28/6,5kW (A3:8) F400	1480	52/18	28/6.5	99.700	59	272	2
27206634__AW	HCF 125 T4/T8 11/3kW (A3:4) F400	1455	21,7/7	11/3	74.100	67	209	2
27207634__AW	HCF 125 T4/T8 14/3,5kW (A3:4) F400	1450	26,5/8,45	14/3.5	85.500	64	209	2
27208634__AW	HCF 125 T4/T8 17/4,3kW (A3:4) F400	1475	33,4/12,7	17/4.3	96.900	60	209	2
27209634__AW	HCF 125 T4/T8 20/5kW (A3:4) F400	1470	38,6/14,1	20/5	107.000	59	237	2

Code	Model	R.P.M.	Rated I. (A) 400V	Rated power kW	Max. Airflow m3/h	Sound db (A)*	Weight	Connect. diagram
27208638__AW	HCF 125 T4/T8 20/5kW (A3:8) F400	1470	38,6/14,1	20/5	84.500	71	242	2
27209634__AW	HCF 125 T4/T8 28/6,5kW (A3:4) F400	1480	52/18	28/6.5	121.000	59	285	2
27210638__AW	HCF 125 T4/T8 28/6,5kW (A3:8) F400	1480	52/18	28/6.5	105.000	66	293	2
27211638__AW	HCF 125 T4/T8 37/9,2kW (A3:8) F400	1485	74,2/25,4	37/9.2	124.000	62	305	2
27212638__AW	HCF 125 T4/T8 44/11kW (A3:8) F400	1480	80,2/27,2	44/11	135.000	61	500	2

Notes:
 * Total sound pressure level at the point of maximum flow measured in dB(A) in the suction measured in free field at a distance of 6m from the source

Dimensions

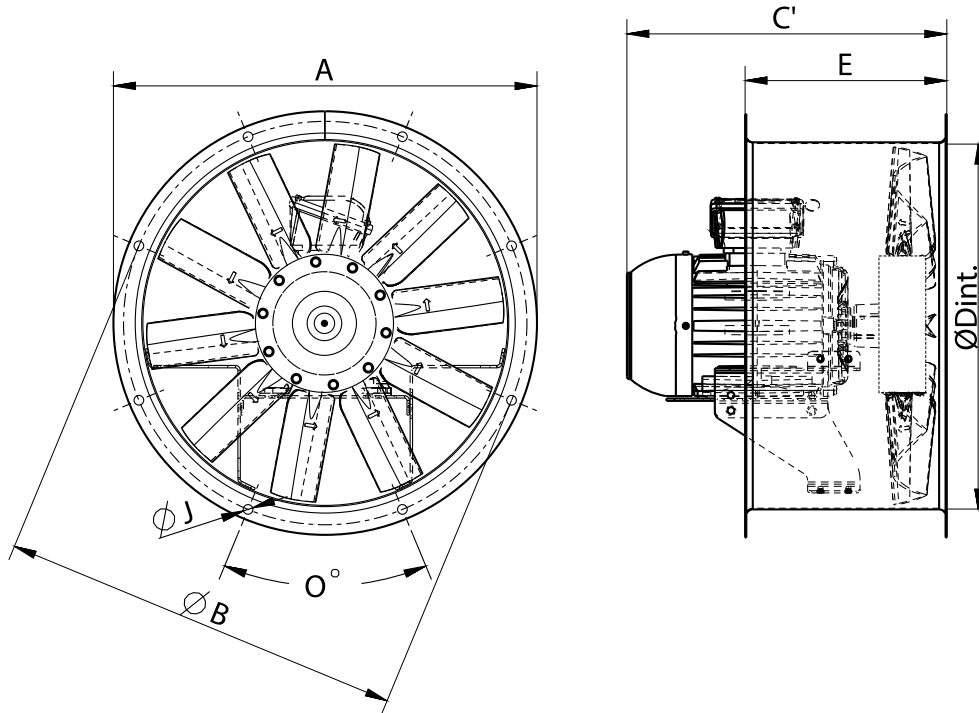

Model	C'	E	O	ØA	ØB	ØDint	ØJ
HCF 45 T4 0,75kW (A5:6) F400	357	250	8x45°	525	500	452	12
HCF 45 T4/T8 0,8/0,2kW (A5:6) F400	357	250	8x45°	525	500	452	12
HCF 50 T4 0,75kW (A5:6) F400	360	250	12x30°	600	560	504	12
HCF 50 T6 0,75kW (A5:6) F400	372	250	12x30°	600	560	504	12
HCF 50 T4/T8 0,8/0,2kW (A5:6) F400	360	250	12x30°	600	560	504	12
HCF 56 T4 0,75kW (A5:6) F400	362	250	12x30°	646	620	559	12
HCF 56 T4 1,1kW (A5:6) F400	372	250	12x30°	646	620	559	12
HCF 56 T4 1,5kW (A5:6) F400	397	250	12x30°	646	620	559	12
HCF 56 T6 0,75kW (A5:6) F400	372	250	12x30°	646	620	559	12
HCF 56 T4/T8 0,8/0,2kW (A5:6) F400	362	250	12x30°	646	620	559	12
HCF 56 T4/T8 1,2/0,3kW (A5:6) F400	372	250	12x30°	646	620	559	12
HCF 56 T4/T8 1,6/0,4kW (A5:6) F400	397	250	12x30°	646	620	559	12
HCF 63 T4 0,75kW (A5:6) F400	359	250	12x30°	725	690	633	12
HCF 63 T4 1,1kW (A5:6) F400	393	250	12x30°	725	690	633	12
HCF 63 T4 1,5kW (A5:6) F400	398	250	12x30°	725	690	633	12
HCF 63 T4 2,2kW (A5:6) F400	450	250	12x30°	725	690	633	12
HCF 63 T6 0,75kW (A5:6) F400	393	250	12x30°	725	690	633	12
HCF 63 T4/T8 0,8/0,2kW (A5:6) F400	359	250	12x30°	725	690	633	12
HCF 63 T4/T8 1,2/0,3kW (A5:6) F400	393	250	12x30°	725	690	633	12
HCF 63 T4/T8 1,6/0,4kW (A5:6) F400	398	250	12x30°	725	690	633	12

Model	C'	E	O	ØA	ØB	ØDint	ØJ
HCF 63 T4/T8 2,2/0,37kW (A5:6) F400	450	250	12x30°	725	690	633	12
HCF 71 T4 0,75kW (A5:6) F400	362	350	16x22,5°	802	770	715	12
HCF 71 T4 1,1kW (A5:6) F400	396	350	16x22,5°	802	770	715	12
HCF 71 T4 1,5kW (A5:6) F400	421	350	16x22,5°	802	770	715	12
HCF 71 T4 2,2kW (A5:6) F400	452	350	16x22,5°	802	770	715	12
HCF 71 T4 3kW (A5:6) F400	452	350	16x22,5°	802	770	715	12
HCF 71 T6 0,75kW (A5:6) F400	396	350	16x22,5°	802	770	715	12
HCF 71 T4/T8 0,8/0,2kW (A5:6) F400	362	350	16x22,5°	802	770	715	12
HCF 71 T4/T8 1,2/0,3kW (A5:6) F400	396	350	16x22,5°	802	770	715	12
HCF 71 T4/T8 1,6/0,4kW (A5:6) F400	421	350	16x22,5°	802	770	715	12
HCF 71 T4/T8 2,2/0,37kW (A5:6) F400	452	350	16x22,5°	802	770	715	12
HCF 71 T4/T8 3/0,55kW (A5:6) F400	452	350	16x22,5°	802	770	715	12
HCF 80 T4 3kW (A5:6) F400	476	350	16x22,5°	892	860	801	12
HCF 80 T4 4kW (A5:6) F400	477	350	16x22,5°	892	860	801	12
HCF 80 T6 0,75kW (A5:6) F400	445	350	16x22,5°	892	860	801	12
HCF 80 T6 1,1kW (A5:6) F400	445	350	16x22,5°	892	860	801	12
HCF 80 T6 1,5kW (A5:6) F400	476	350	16x22,5°	892	860	801	12
HCF 80 T6 2,2kW (A5:6) F400	477	350	16x22,5°	892	860	801	12
HCF 80 T4/T8 3/0,55kW (A5:6) F400	476	350	16x22,5°	892	860	801	12
HCF 80 T4/T8 4/0,75kW (A5:6) F400	477	350	16x22,5°	892	860	801	12
HCF 90 T4 3kW (A3:4) F400	655	425	16x22,5°	1000	970	903,5	12
HCF 90 T4 4kW (A3:4) F400	655	425	16x22,5°	1000	970	903,5	12
HCF 90 T4 5,5kW (A3:4) F400	655	425	16x22,5°	1000	970	903,5	12
HCF 90 T4 5,5kW (A3:8) F400	655	425	16x22,5°	1000	970	903,5	12
HCF 90 T4 7,5kW (A3:4) F400	655	425	16x22,5°	1000	970	903,5	12
HCF 90 T4 7,5kW (A3:8) F400	655	425	16x22,5°	1000	970	903,5	12
HCF 90 T4 11kW (A3:4) F400	718	425	16x22,5°	1000	970	903,5	12
HCF 90 T4 11kW (A3:8) F400	718	425	16x22,5°	1000	970	903,5	12
HCF 90 T4 15kW (A3:8) F400	762	425	16x22,5°	1000	970	903,5	12
HCF 90 T6 1,5kW (A3:4) F400	655	425	16x22,5°	1000	970	903,5	12
HCF 90 T6 1,5kW (A3:8) F400	655	425	16x22,5°	1000	970	903,5	12
HCF 90 T6 2,2kW (A3:4) F400	655	425	16x22,5°	1000	970	903,5	12
HCF 90 T6 2,2kW (A3:8) F400	655	425	16x22,5°	1000	970	903,5	12
HCF 90 T6 3kW (A3:8) F400	655	425	16x22,5°	1000	970	903,5	12
HCF 90 T6 4kW (A3:8) F400	655	425	16x22,5°	1000	970	903,5	12
HCF 90 T4/T8 2,8/0,7kW (A3:4) F400	655	425	16x22,5°	1000	970	903,5	12
HCF 90 T4/T8 4/0,75kW (A3:4) F400	655	425	16x22,5°	1000	970	903,5	12
HCF 90 T4/T8 5,5/1,1kW (A3:4) F400	655	425	16x22,5°	1000	970	903,5	12
HCF 90 T4/T8 5,5/1,1kW (A3:8) F400	655	425	16x22,5°	1000	970	903,5	12
HCF 90 T4/T8 7,5/1,5kW (A3:4) F400	655	425	16x22,5°	1000	970	903,5	12

Model	C'	E	O	ØA	ØB	ØDint	ØJ
HCF 90 T4/T8 7,5/1,5kW (A3:8) F400	655	425	16x22,5°	1000	970	903,5	12
HCF 90 T4/T8 11/3kW (A3:4) F400	718	425	16x22,5°	1000	970	903,5	12
HCF 90 T4/T8 11/3kW (A3:8) F400	718	425	16x22,5°	1000	970	903,5	12
HCF 90 T4/T8 14/3,5kW (A3:8) F400	762	425	16x22,5°	1000	970	903,5	12
HCF 100 T4 5,5kW (A3:4) F400	655	425	16x22,5°	1115	1070	1013	12
HCF 100 T4 7,5kW (A3:4) F400	655	425	16x22,5°	1115	1070	1013	12
HCF 100 T4 7,5kW (A3:8) F400	655	425	16x22,5°	1115	1070	1013	12
HCF 100 T4 11kW (A3:4) F400	718	425	16x22,5°	1115	1070	1013	12
HCF 100 T4 11kW (A3:8) F400	718	425	16x22,5°	1115	1070	1013	12
HCF 100 T4 15kW (A3:4) F400	762	425	16x22,5°	1115	1070	1013	12
HCF 100 T4 15kW (A3:8) F400	762	425	16x22,5°	1115	1070	1013	12
HCF 100 T4 18,5kW (A3:8) F400	756	425	16x22,5°	1115	1070	1013	12
HCF 100 T4 22kW (A3:8) F400	794	425	16x22,5°	1115	1070	1013	12
HCF 100 T6 1,5kW (A3:4) F400	655	425	16x22,5°	1115	1070	1013	12
HCF 100 T6 2,2kW (A3:4) F400	655	425	16x22,5°	1115	1070	1013	12
HCF 100 T6 2,2kW (A3:8) F400	655	425	16x22,5°	1115	1070	1013	12
HCF 100 T6 3kW (A3:4) F400	655	425	16x22,5°	1115	1070	1013	12
HCF 100 T6 3kW (A3:8) F400	655	425	16x22,5°	1115	1070	1013	12
HCF 100 T6 4kW (A3:4) F400	655	425	16x22,5°	1115	1070	1013	12
HCF 100 T6 4kW (A3:8) F400	655	425	16x22,5°	1115	1070	1013	12
HCF 100 T6 5,5kW (A3:8) F400	655	425	16x22,5°	1115	1070	1013	12
HCF 100 T4/T8 5,5/1,1kW (A3:4) F400	655	425	16x22,5°	1115	1070	1013	12
HCF 100 T4/T8 7,5/1,5kW (A3:4) F400	655	425	16x22,5°	1115	1070	1013	12
HCF 100 T4/T8 7,5/1,5kW (A3:8) F400	655	425	16x22,5°	1115	1070	1013	12
HCF 100 T4/T8 11/3kW (A3:4) F400	718	425	16x22,5°	1115	1070	1013	12
HCF 100 T4/T8 11/3kW (A3:8) F400	718	425	16x22,5°	1115	1070	1013	12
HCF 100 T4/T8 14/3,5kW (A3:4) F400	762	425	16x22,5°	1115	1070	1013	12
HCF 100 T4/T8 14/3,5kW (A3:8) F400	762	425	16x22,5°	1115	1070	1013	12
HCF 100 T4/T8 17/4,3kW (A3:8) F400	756	425	16x22,5°	1115	1070	1013	12
HCF 100 T4/T8 20/5kW (A3:8) F400	794	425	16x22,5°	1115	1070	1013	12
HCF 112 T4 5,5kW (A3:4) F400	765	500	16x22,5°	1234	1190	1132	12
HCF 112 T4 7,5kW (A3:4) F400	765	500	16x22,5°	1234	1190	1132	12
HCF 112 T4 11kW (A3:4) F400	765	500	16x22,5°	1234	1190	1132	12
HCF 112 T4 11kW (A3:8) F400	765	500	16x22,5°	1234	1190	1132	12
HCF 112 T4 15kW (A3:4) F400	772	500	16x22,5°	1234	1190	1132	12
HCF 112 T4 15kW (A3:8) F400	772	500	16x22,5°	1234	1190	1132	12
HCF 112 T4 18,5kW (A3:4) F400	766	500	16x22,5°	1234	1190	1132	12
HCF 112 T4 18,5kW (A3:8) F400	766	500	16x22,5°	1234	1190	1132	12
HCF 112 T4 22kW (A3:8) F400	804	500	16x22,5°	1234	1190	1132	12
HCF 112 T4 30kW (A3:8) F400	869	500	16x22,5°	1234	1190	1132	12

Model	C'	E	O	ØA	ØB	ØDint	ØJ
HCF 112 T6 2,2kW (A3:4) F400	765	500	16x22,5°	1234	1190	1132	12
HCF 112 T6 3kW (A3:4) F400	765	500	16x22,5°	1234	1190	1132	12
HCF 112 T6 3kW (A3:8) F400	765	500	16x22,5°	1234	1190	1132	12
HCF 112 T6 4kW (A3:4) F400	765	500	16x22,5°	1234	1190	1132	12
HCF 112 T6 4kW (A3:8) F400	765	500	16x22,5°	1234	1190	1132	12
HCF 112 T6 5,5kW (A3:4) F400	765	500	16x22,5°	1234	1190	1132	12
HCF 112 T6 5,5kW (A3:8) F400	765	500	16x22,5°	1234	1190	1132	12
HCF 112 T6 7,5kW (A3:8) F400	765	500	16x22,5°	1234	1190	1132	12
HCF 112 T4/T8 5,5/1,1kW (A3:4) F400	765	500	16x22,5°	1234	1190	1132	12
HCF 112 T4/T8 7,5/1,5kW (A3:4) F400	765	500	16x22,5°	1234	1190	1132	12
HCF 112 T4/T8 11/3kW (A3:4) F400	765	500	16x22,5°	1234	1190	1132	12
HCF 112 T4/T8 11/3kW (A3:8) F400	765	500	16x22,5°	1234	1190	1132	12
HCF 112 T4/T8 14/3,5kW (A3:4) F400	772	500	16x22,5°	1234	1190	1132	12
HCF 112 T4/T8 14/3,5kW (A3:8) F400	772	500	16x22,5°	1234	1190	1132	12
HCF 112 T4/T8 17/4,3kW (A3:4) F400	766	500	16x22,5°	1234	1190	1132	12
HCF 112 T4/T8 17/4,3kW (A3:8) F400	766	500	16x22,5°	1234	1190	1132	12
HCF 112 T4/T8 20/5kW (A3:8) F400	804	500	16x22,5°	1234	1190	1132	12
HCF 112 T4/T8 28/6,5kW (A3:8) F400	869	500	16x22,5°	1234	1190	1132	12
HCF 125 T4 11kW (A3:4) F400	765	500	20x18°	1365	1320	1263	15
HCF 125 T4 15kW (A3:4) F400	772	500	20x18°	1365	1320	1263	15
HCF 125 T4 18,5kW (A3:4) F400	766	500	20x18°	1365	1320	1263	15
HCF 125 T4 18,5kW (A3:8) F400	766	500	20x18°	1365	1320	1263	15
HCF 125 T4 22kW (A3:4) F400	804	500	20x18°	1365	1320	1263	15
HCF 125 T4 22kW (A3:8) F400	804	500	20x18°	1365	1320	1263	15
HCF 125 T4 30kW (A3:4) F400	869	500	20x18°	1365	1320	1263	15
HCF 125 T4 30kW (A3:8) F400	869	500	20x18°	1365	1320	1263	15
HCF 125 T4 37kW (A3:8) F400	954	500	20x18°	1365	1320	1263	15
HCF 125 T4 45kW (A3:8) F400	954	500	20x18°	1365	1320	1263	15
HCF 125 T6 3kW (A3:4) F400	765	500	20x18°	1365	1320	1263	15
HCF 125 T6 4kW (A3:4) F400	765	500	20x18°	1365	1320	1263	15
HCF 125 T6 5,5kW (A3:4) F400	765	500	20x18°	1365	1320	1263	15
HCF 125 T6 5,5kW (A3:8) F400	765	500	20x18°	1365	1320	1263	15
HCF 125 T6 7,5kW (A3:4) F400	765	500	20x18°	1365	1320	1263	15
HCF 125 T6 7,5kW (A3:8) F400	765	500	20x18°	1365	1320	1263	15
HCF 125 T6 11kW (A3:8) F400	772	500	20x18°	1365	1320	1263	15
HCF 125 T6 15kW (A3:8) F400	804	500	20x18°	1365	1320	1263	15
HCF 125 T4/T8 11/3kW (A3:4) F400	765	500	20x18°	1365	1320	1263	15
HCF 125 T4/T8 14/3,5kW (A3:4) F400	772	500	20x18°	1365	1320	1263	15
HCF 125 T4/T8 17/4,3kW (A3:4) F400	766	500	20x18°	1365	1320	1263	15
HCF 125 T4/T8 20/5kW (A3:4) F400	804	500	20x18°	1365	1320	1263	15

Model	C'	E	O	ØA	ØB	ØDint	ØJ
HCF 125 T4/T8 20/5kW (A3:8) F400	804	500	20x18°	1365	1320	1263	15
HCF 125 T4/T8 28/6,5kW (A3:4) F400	869	500	20x18°	1365	1320	1263	15
HCF 125 T4/T8 28/6,5kW (A3:8) F400	869	500	20x18°	1365	1320	1263	15
HCF 125 T4/T8 37/9,2kW (A3:8) F400	954	500	20x18°	1365	1320	1263	15
HCF 125 T4/T8 44/11kW (A3:8) F400	954	500	20x18°	1365	1320	1263	15

Wiring diagram

DIAGRAM Nº 1

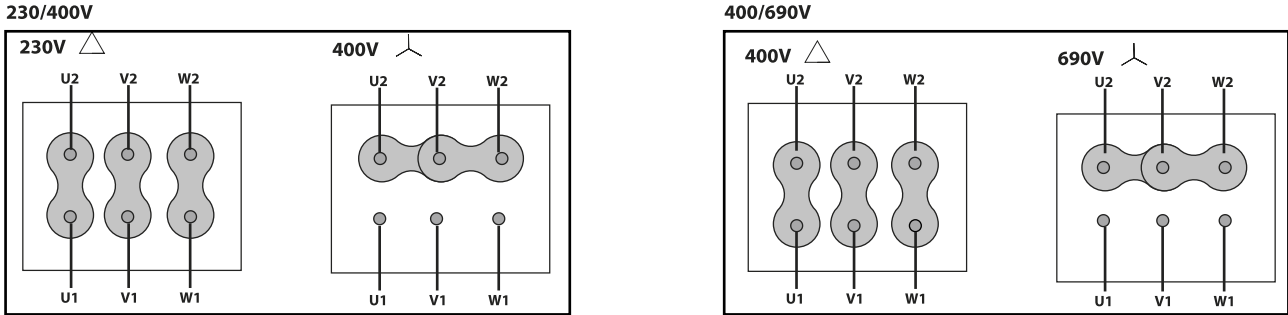
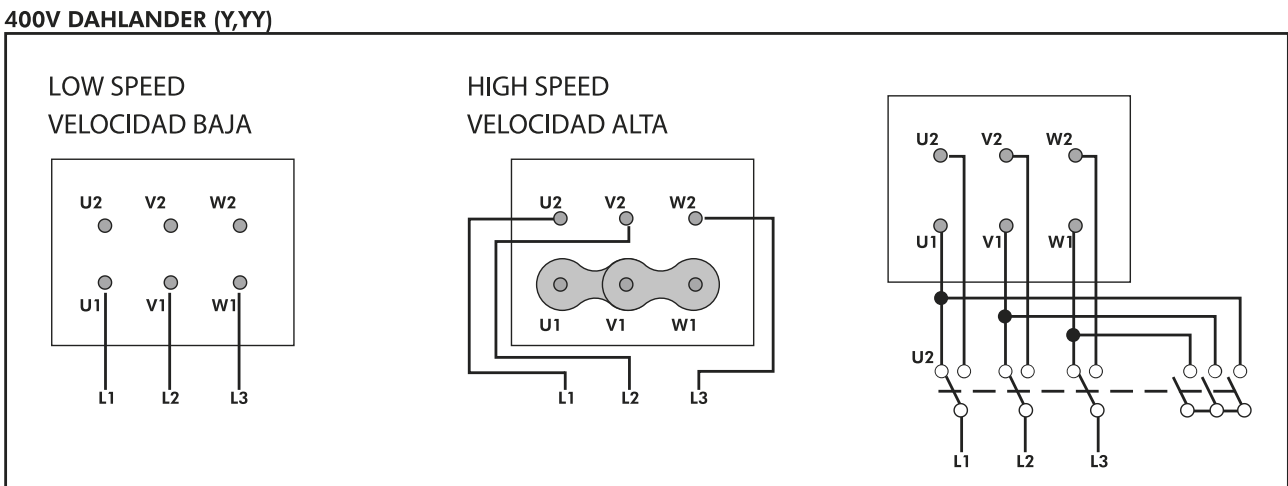

DIAGRAM Nº 2



CHARACTERISCTIC CURVE

HCF 45 T4 0,75kW (A5:6) F400

AIR FLOW - PRESSURE

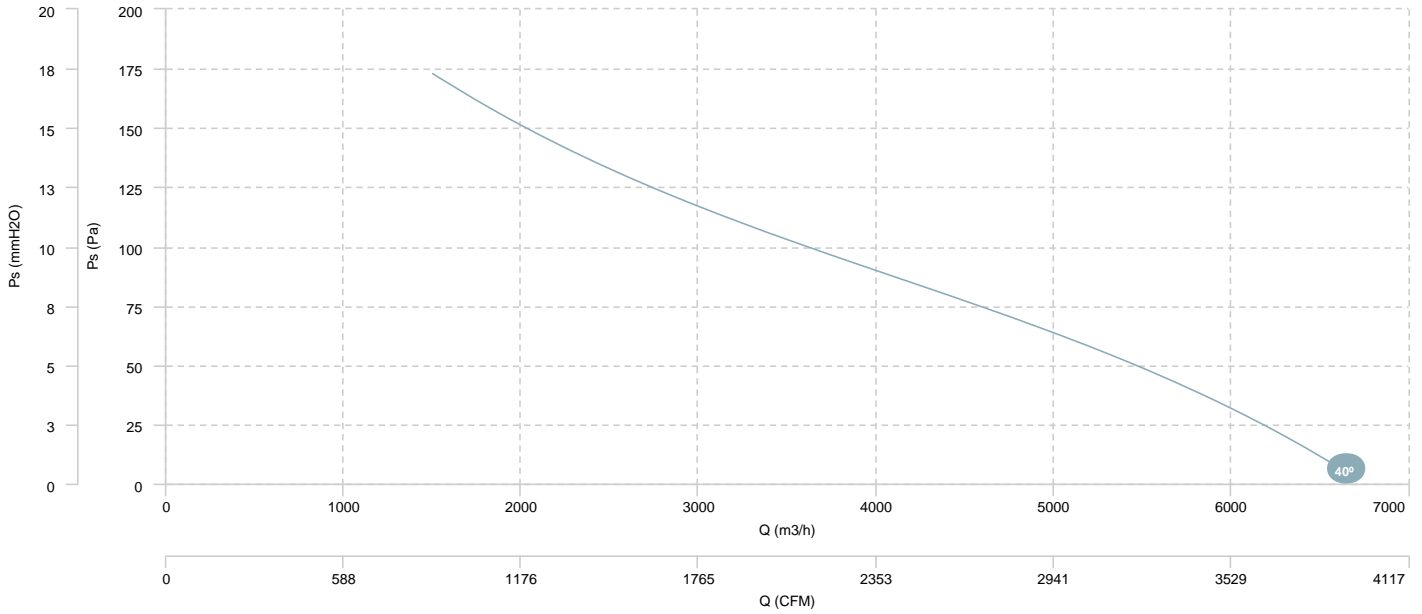

AIR FLOW - ABSORBED POWER

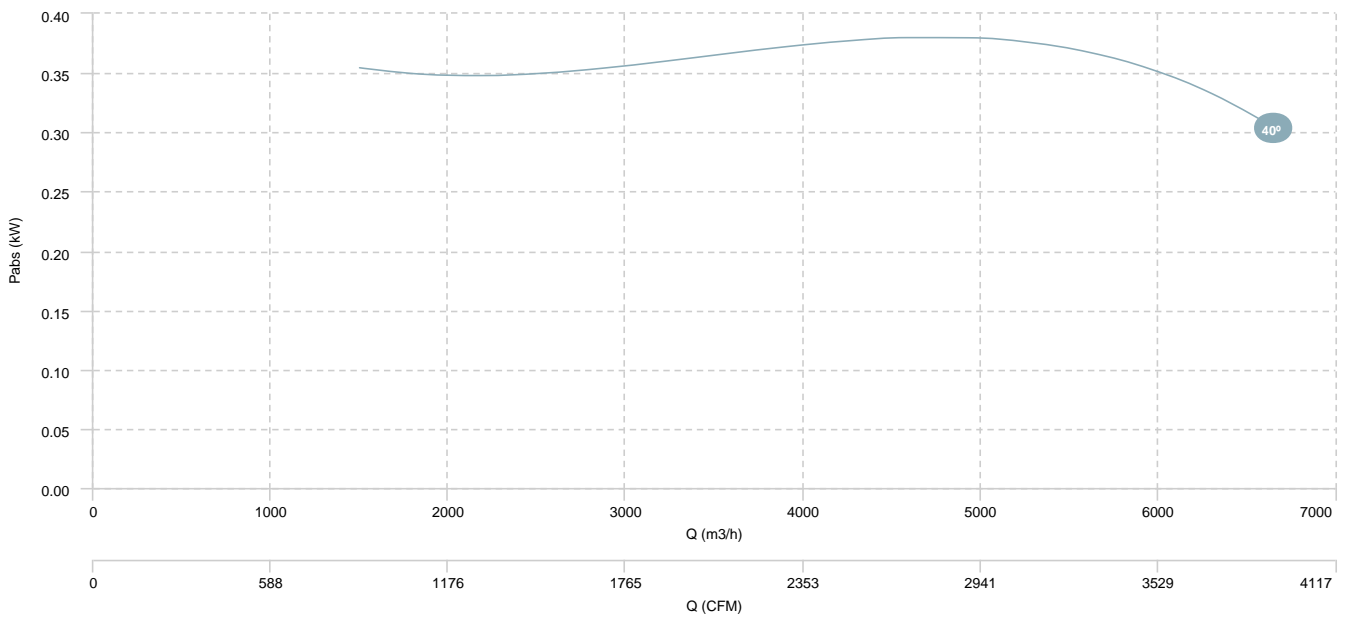

HCF 45 T4/T8 0,8/0,2kW (A5:6) F400

AIR FLOW - PRESSURE (4 poles)

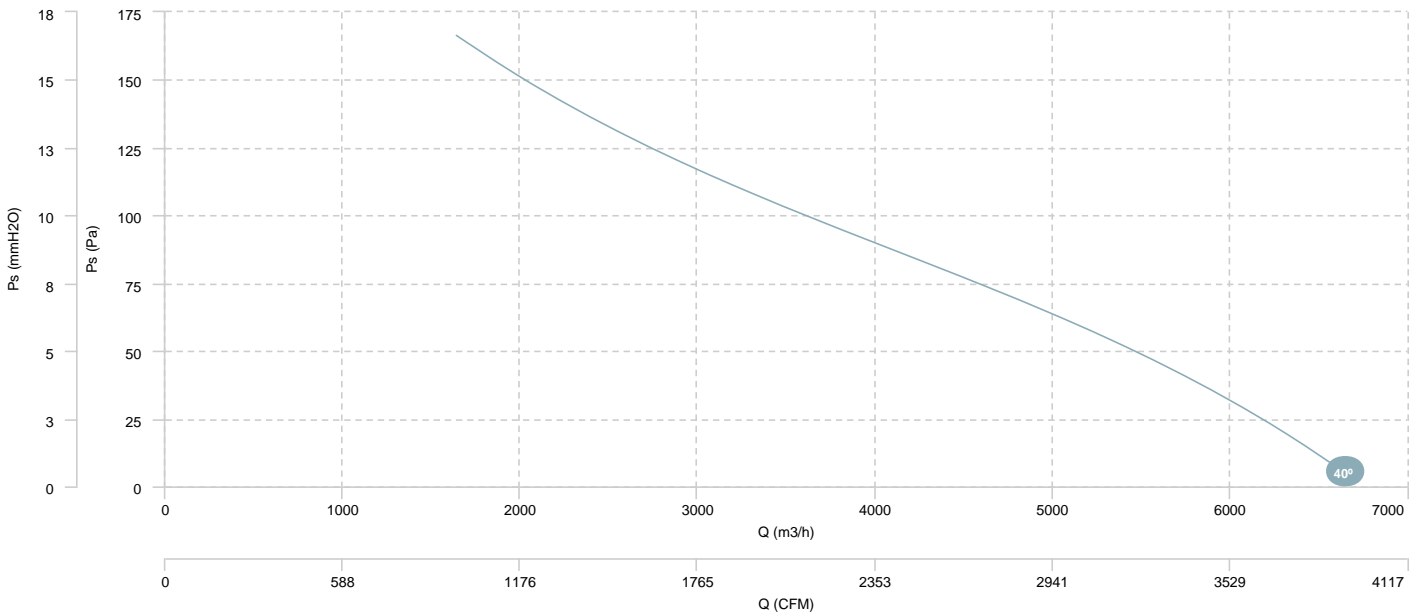

AIR FLOW - ABSORBED POWER (4 poles)

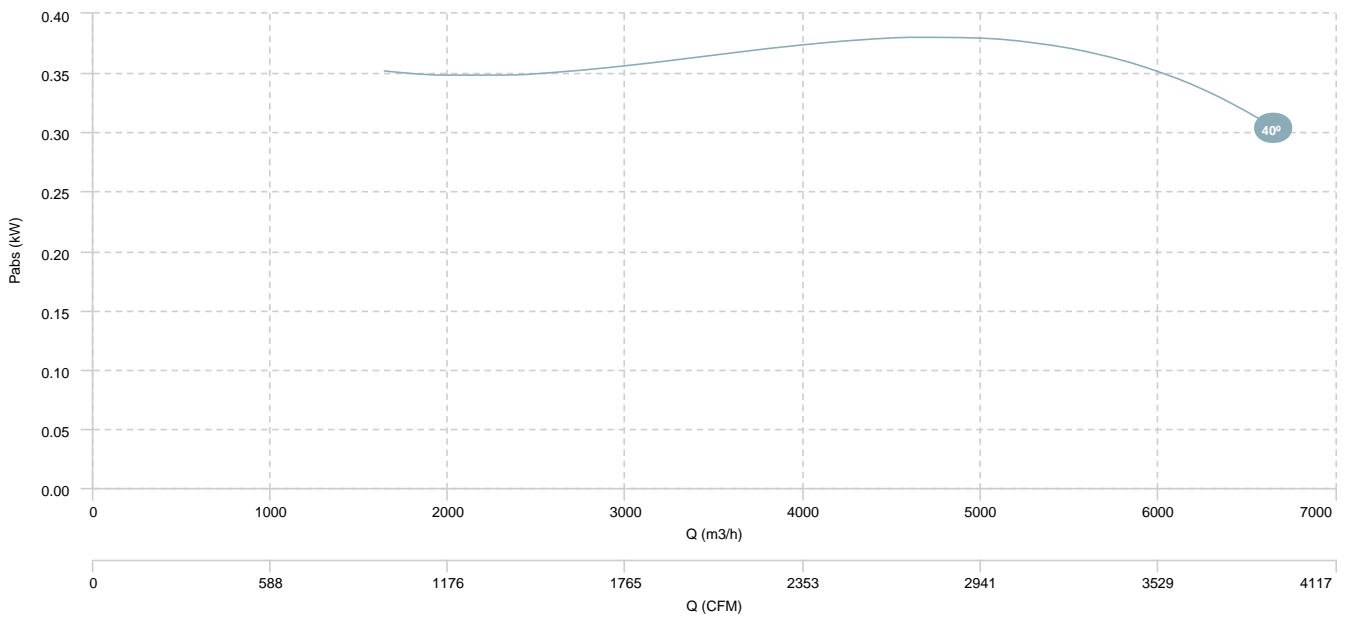

HCF 45 T4/T8 0,8/0,2kW (A5:6) F400

AIR FLOW - PRESSURE (8 poles)

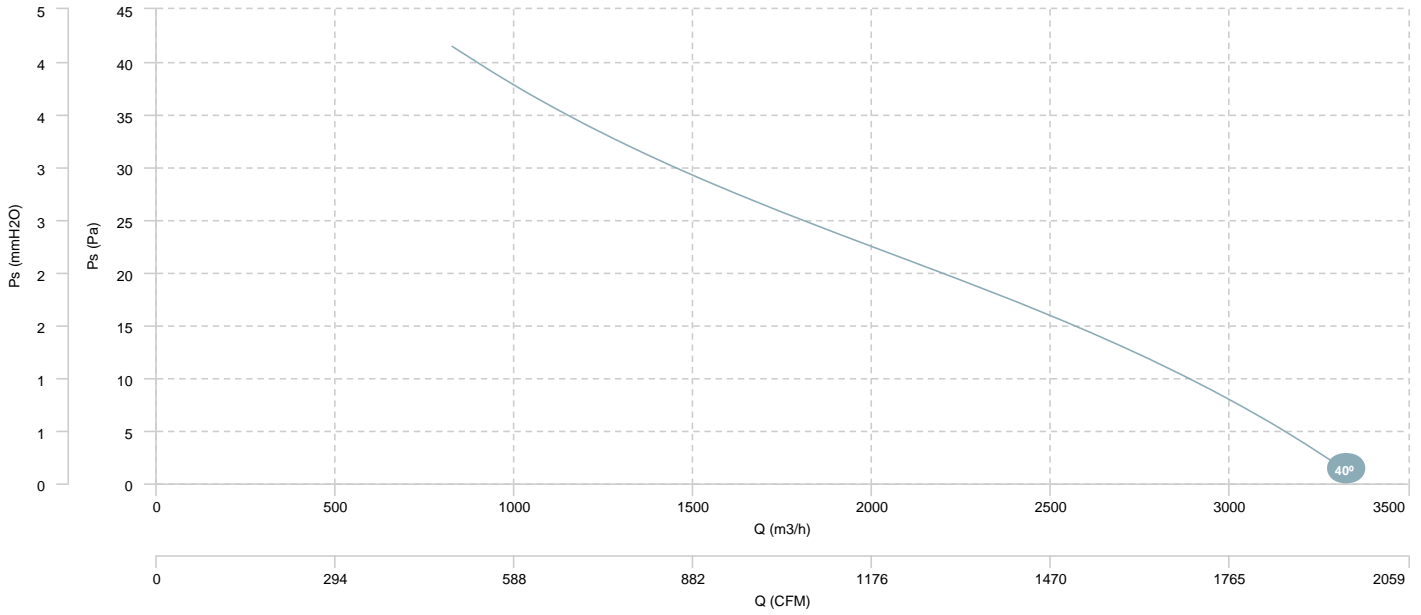

HCF 50 T4 0,75kW (A5:6) F400

AIR FLOW - PRESSURE

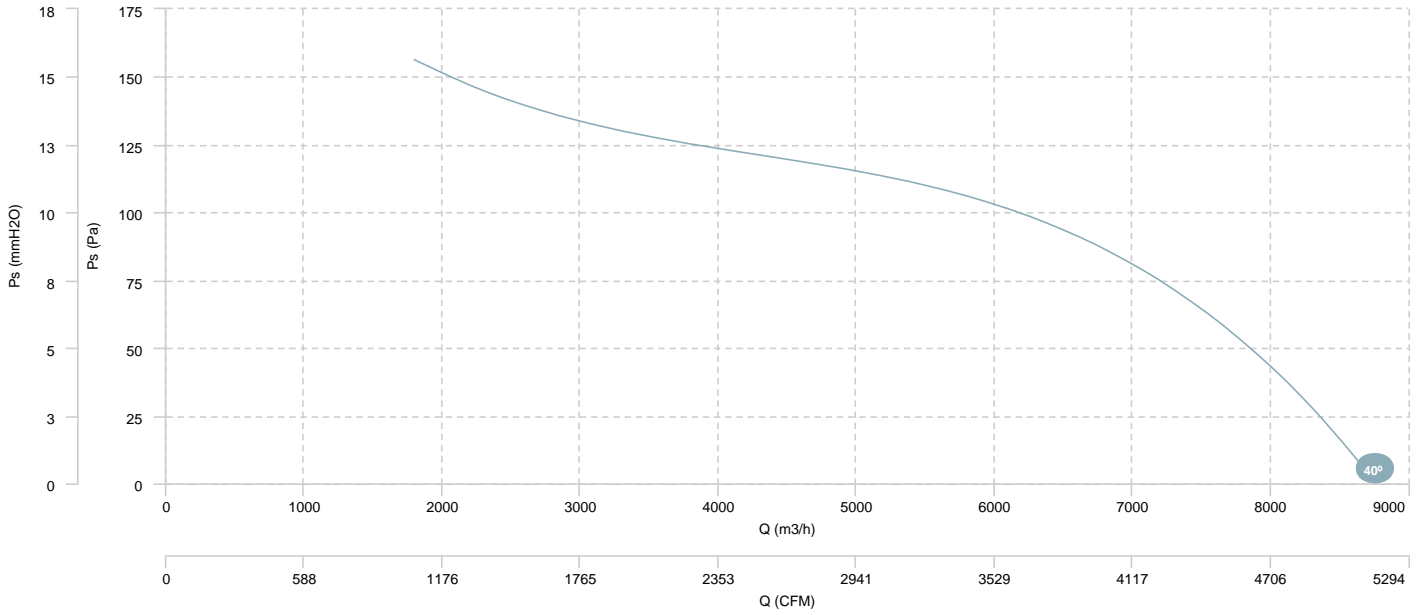

AIR FLOW - ABSORBED POWER

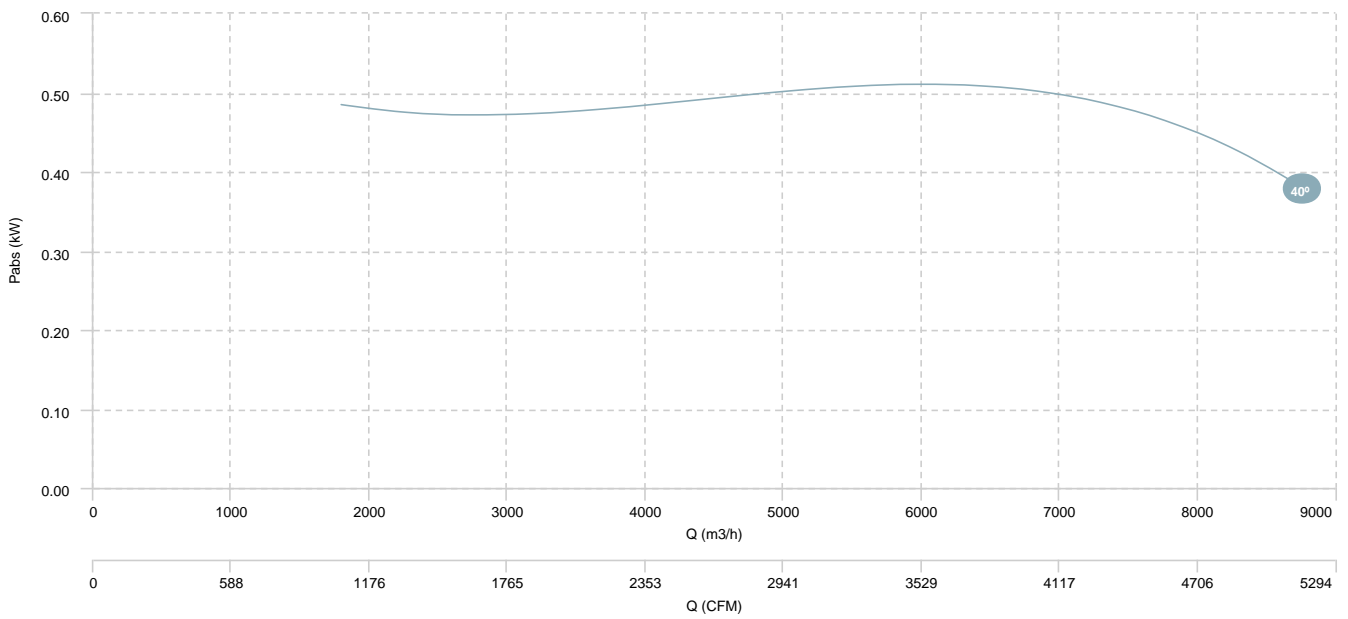

HCF 50 T6 0,75kW (A5:6) F400

AIR FLOW - PRESSURE

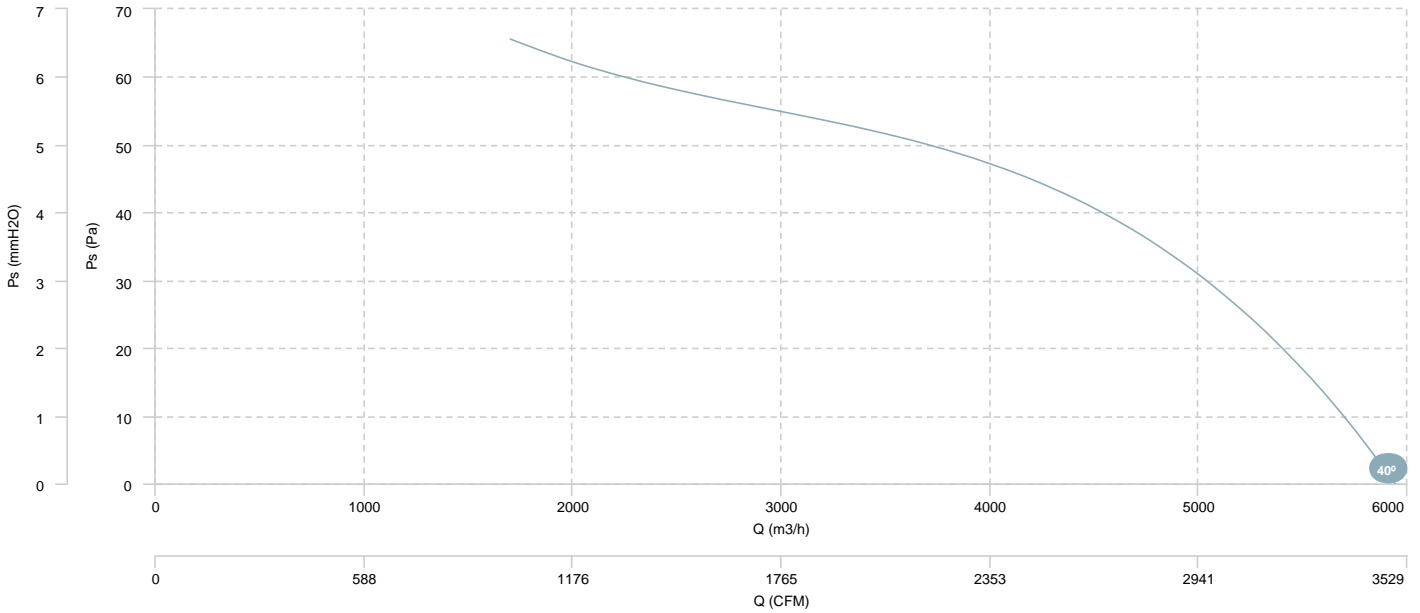

AIR FLOW - ABSORBED POWER

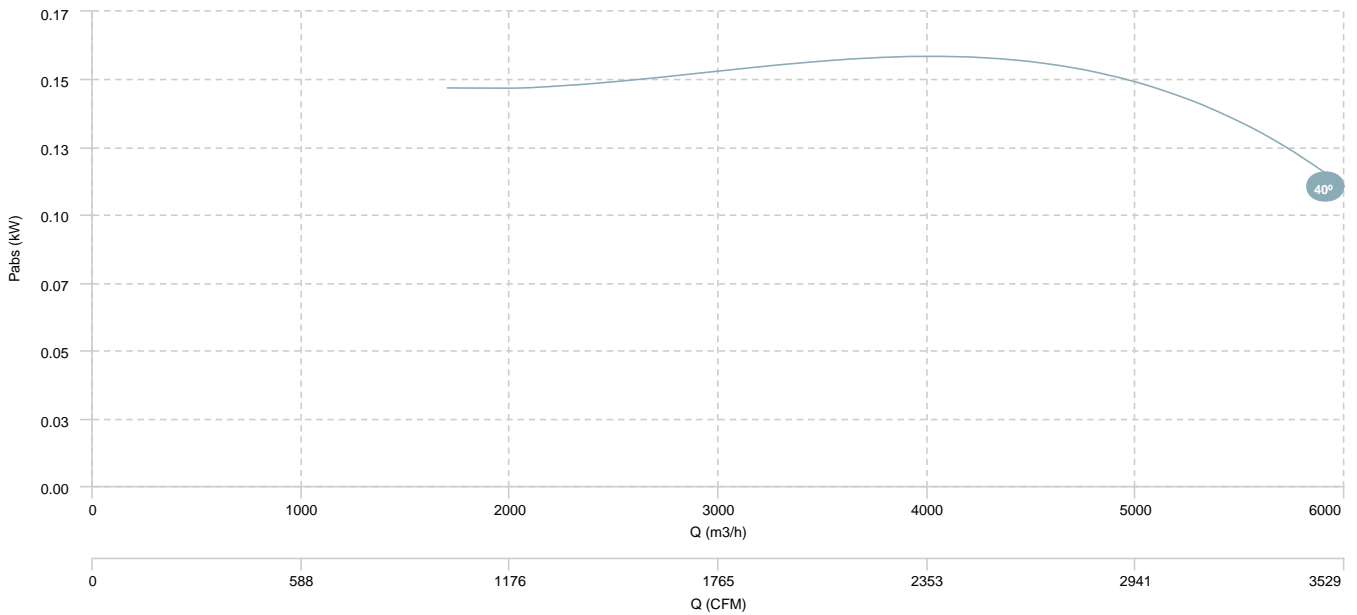

HCF 50 T4/T8 0,8/0,2kW (A5:6) F400

AIR FLOW - PRESSURE (4 poles)

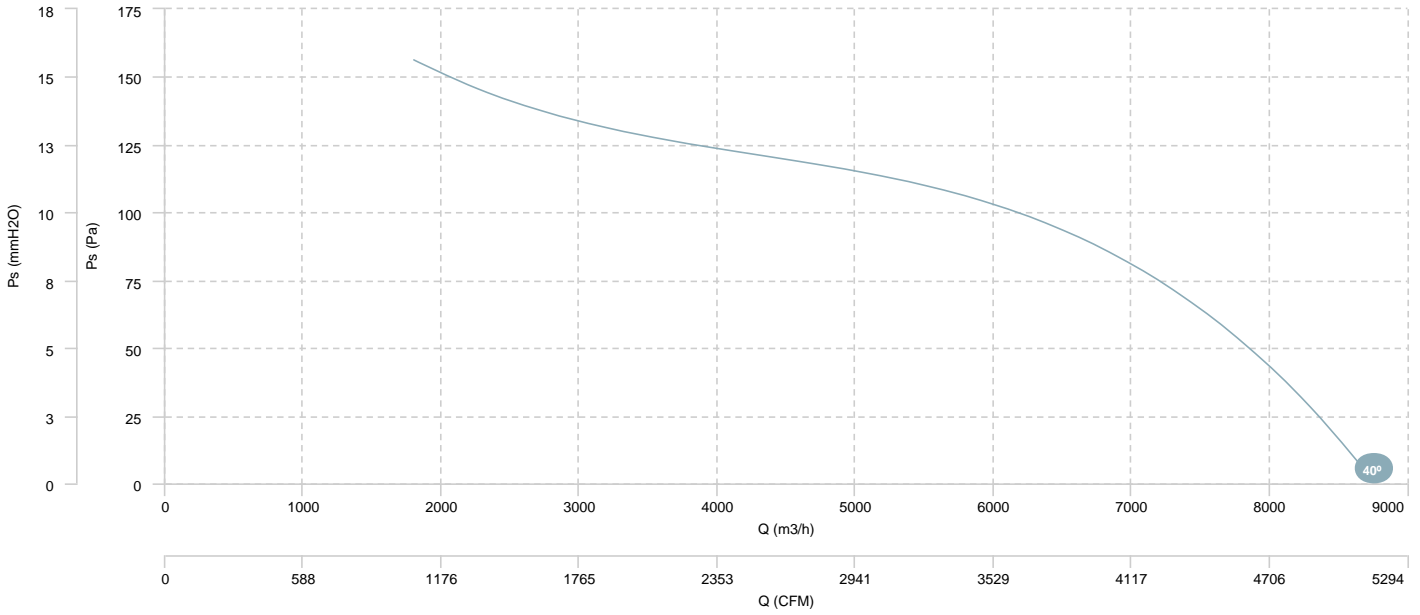

AIR FLOW - ABSORBED POWER (4 poles)

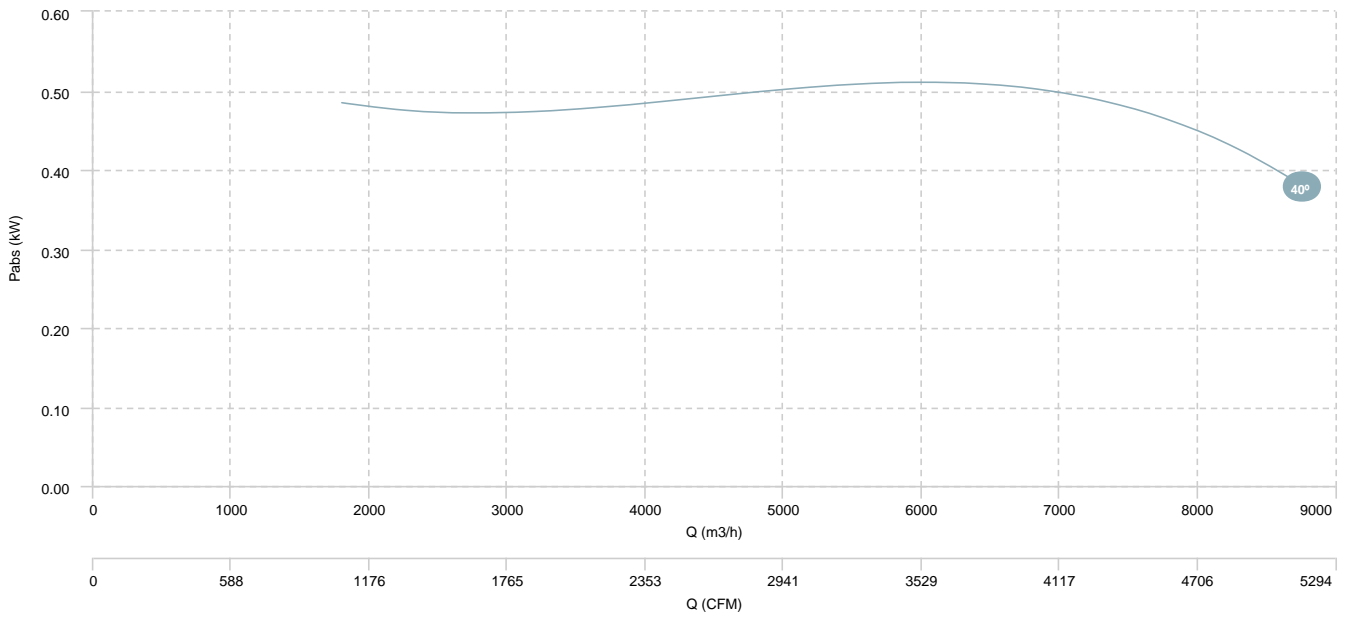

HCF 50 T4/T8 0,8/0,2kW (A5:6) F400

AIR FLOW - PRESSURE (8 poles)

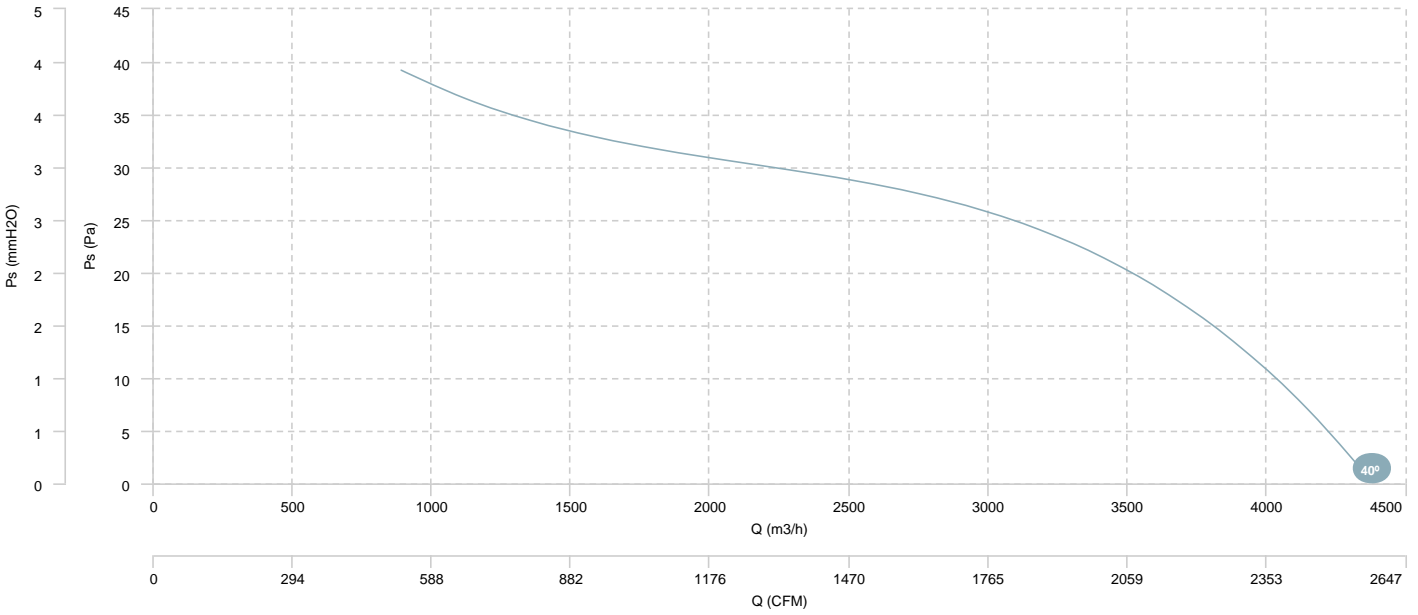

HCF 56 T4 0,75kW (A5:6) F400

HCF 56 T4 1,1kW (A5:6) F400

HCF 56 T4 1,5kW (A5:6) F400

AIR FLOW - PRESSURE

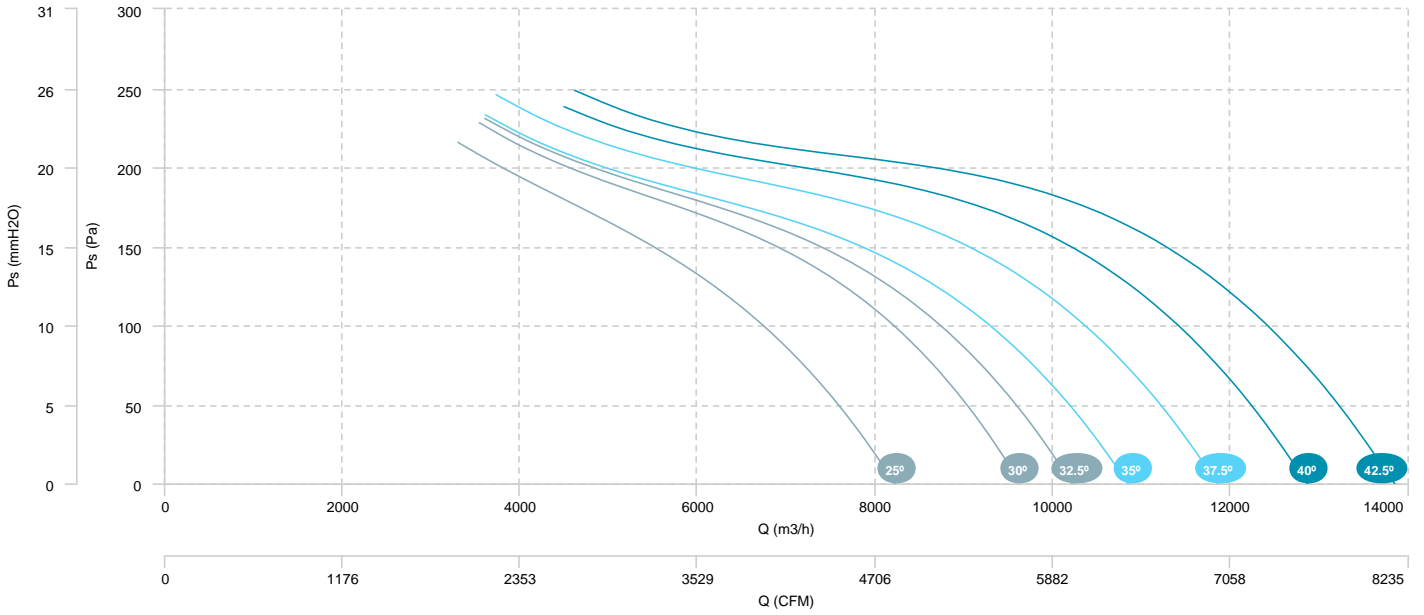

AIR FLOW - ABSORBED POWER

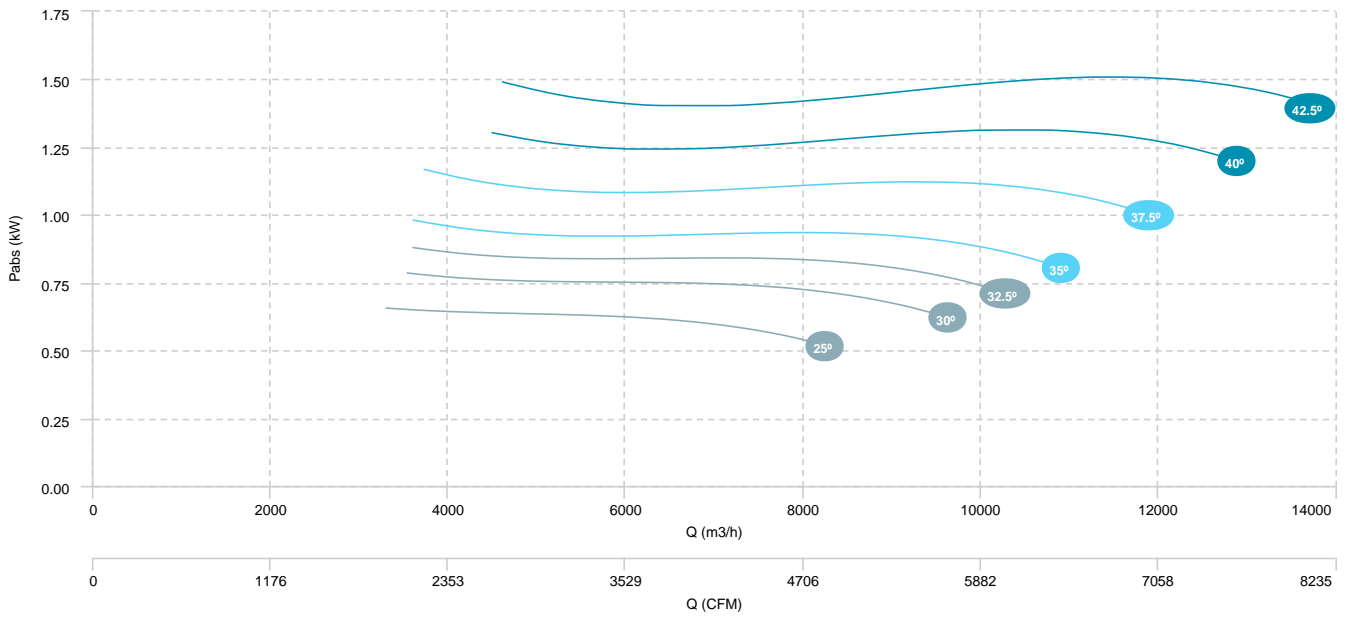

HCF 56 T6 0,75kW (A5:6) F400

AIR FLOW - PRESSURE

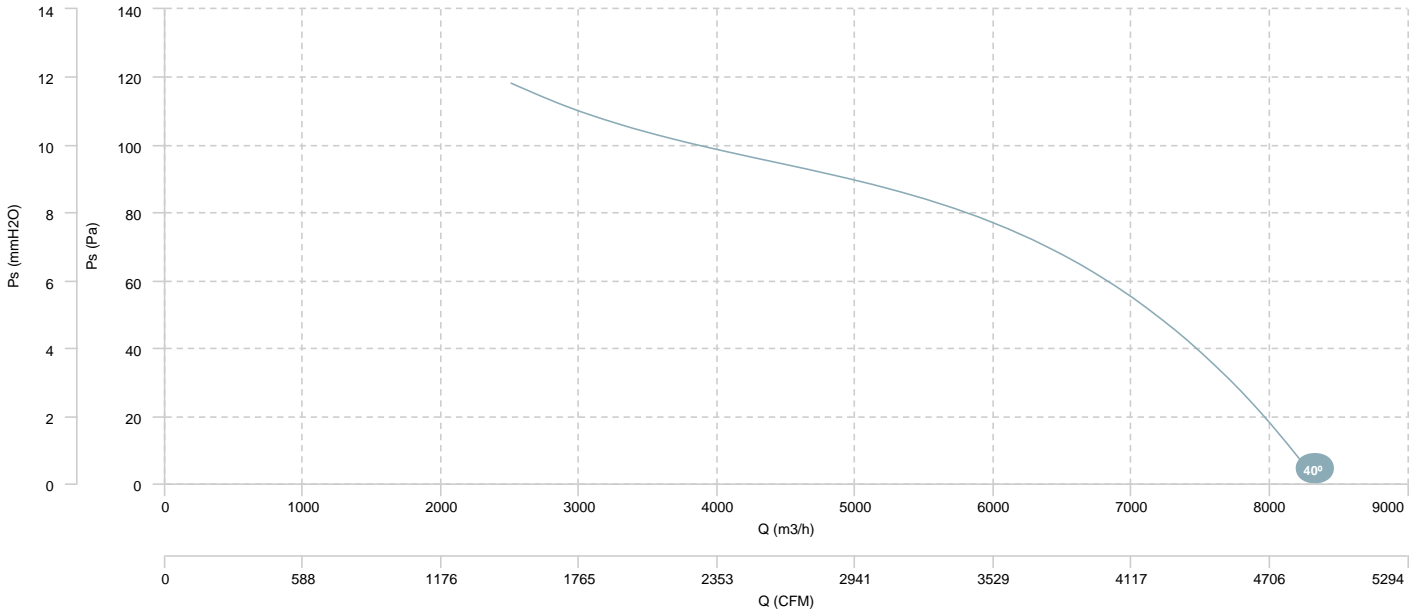

AIR FLOW - ABSORBED POWER

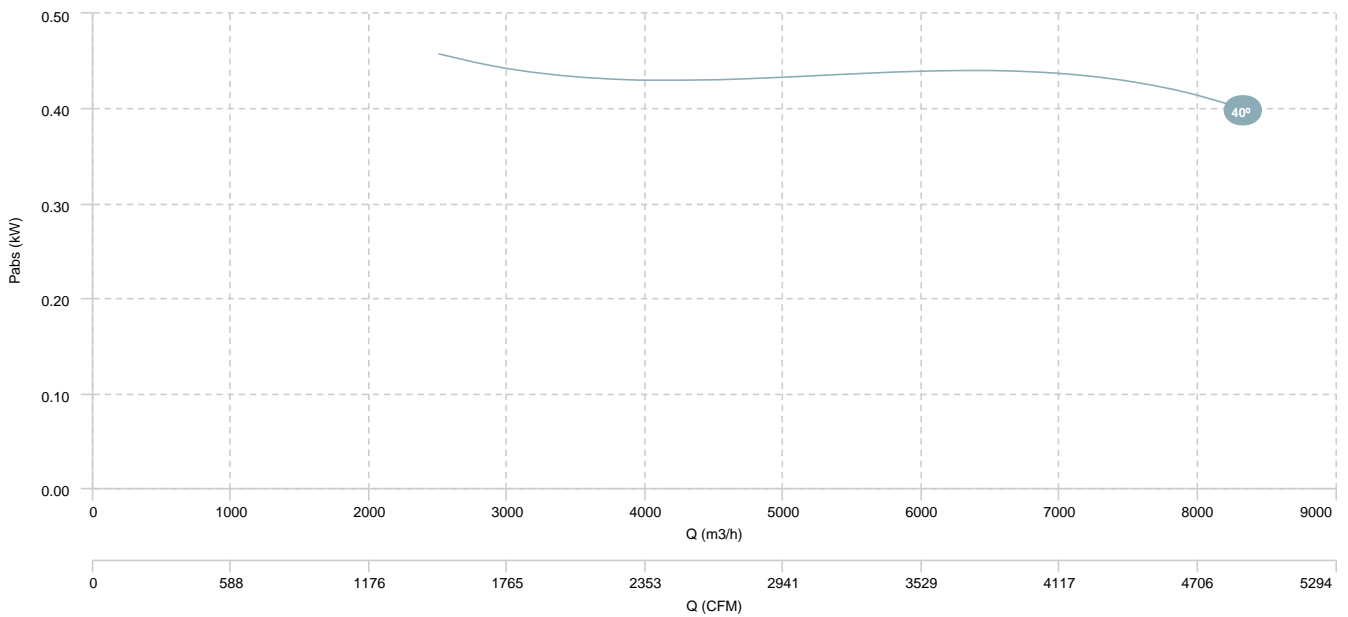

HCF 56 T4/T8 0,8/0,2kW (A5:6) F400

HCF 56 T4/T8 1,2/0,3kW (A5:6) F400

HCF 56 T4/T8 1,6/0,4kW (A5:6) F400

AIR FLOW - PRESSURE (4 poles)

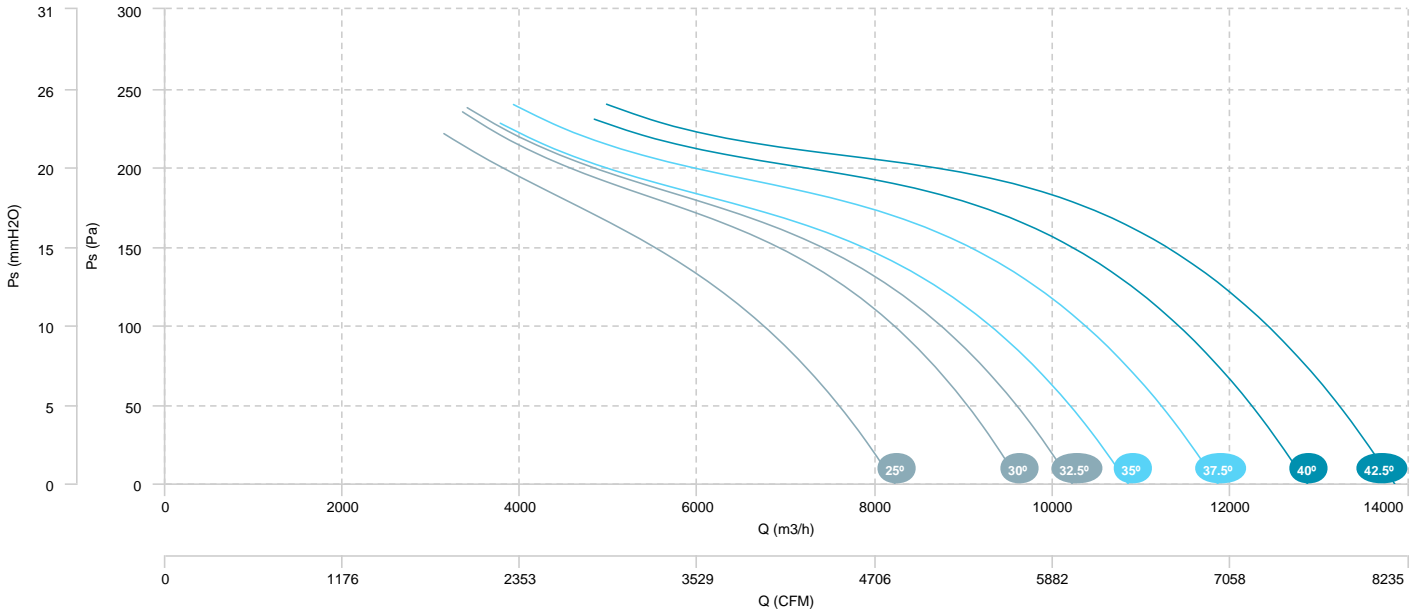

AIR FLOW - ABSORBED POWER (4 poles)

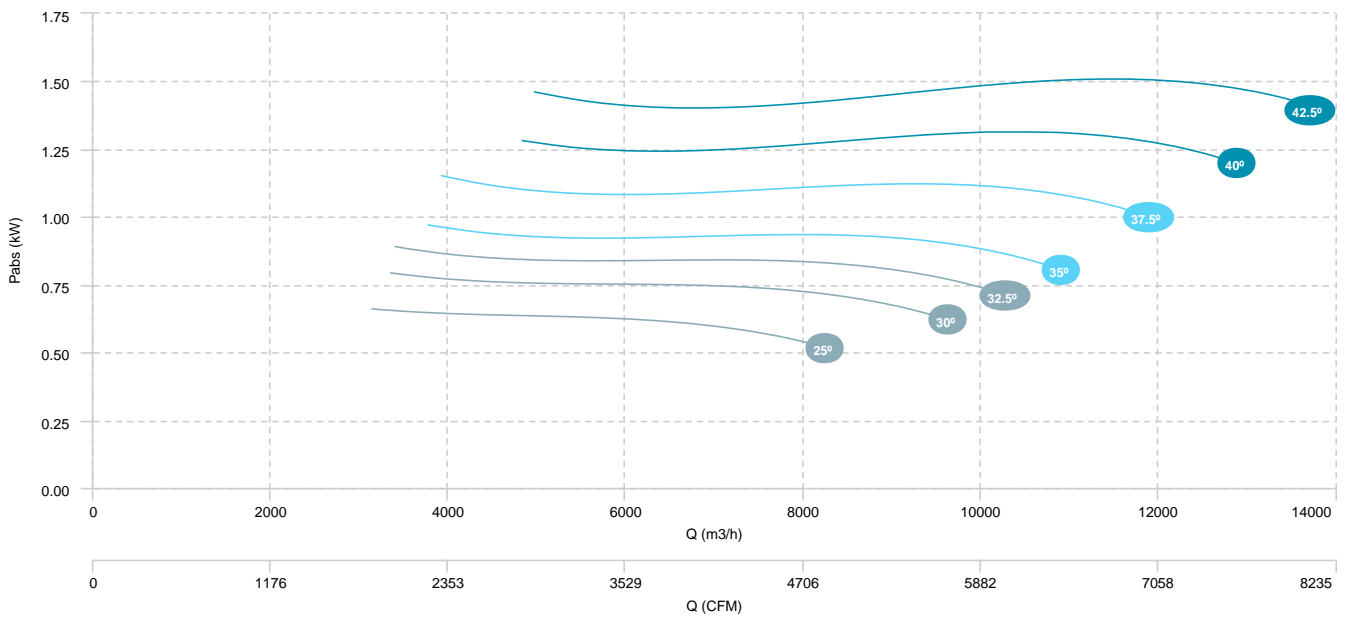

HCF 56 T4/T8 0,8/0,2kW (A5:6) F400

HCF 56 T4/T8 1,2/0,3kW (A5:6) F400

HCF 56 T4/T8 1,6/0,4kW (A5:6) F400

AIR FLOW - PRESSURE (8 poles)

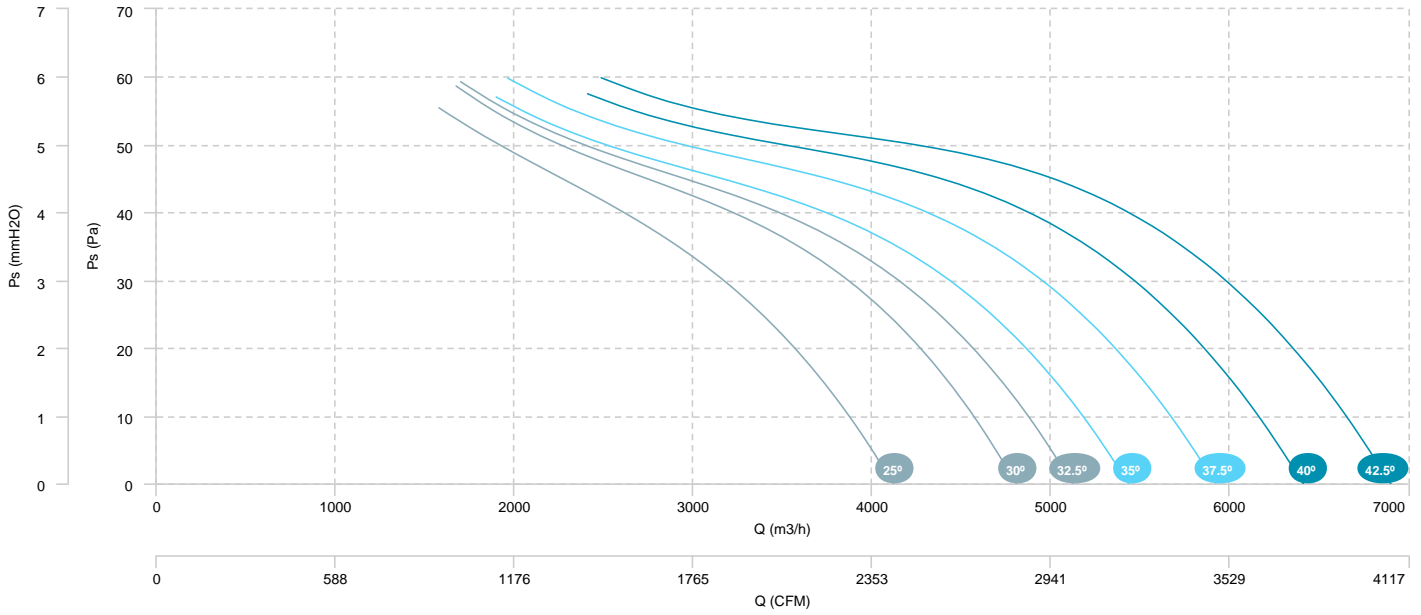

HCF 63 T4 0,75kW (A5:6) F400	HCF 63 T4 1,1kW (A5:6) F400	HCF 63 T4 1,5kW (A5:6) F400
HCF 63 T4 2,2kW (A5:6) F400		

AIR FLOW - PRESSURE

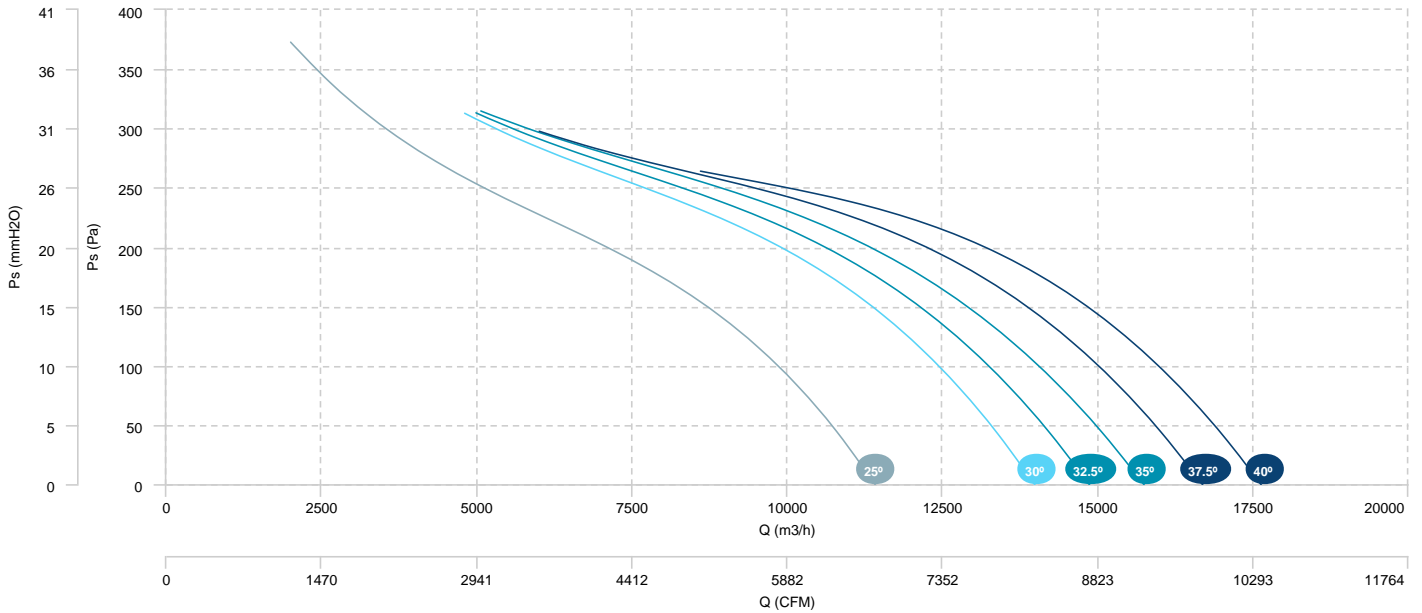

AIR FLOW - ABSORBED POWER

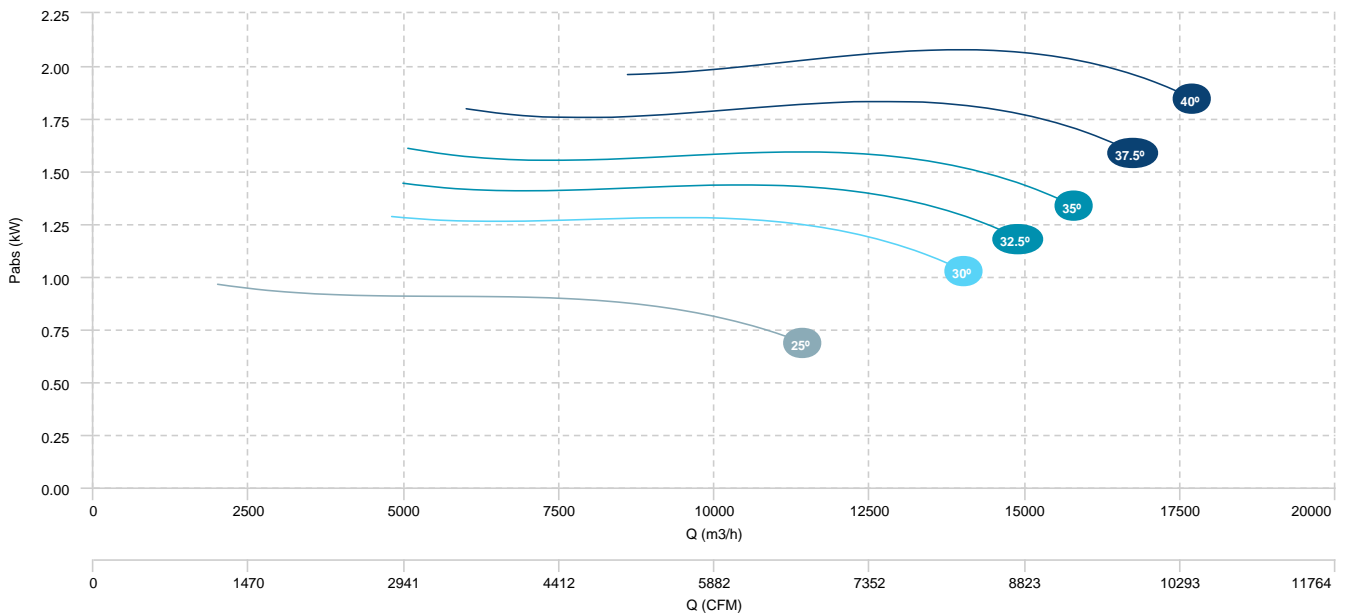

HCF 63 T6 0,75kW (A5:6) F400

AIR FLOW - PRESSURE

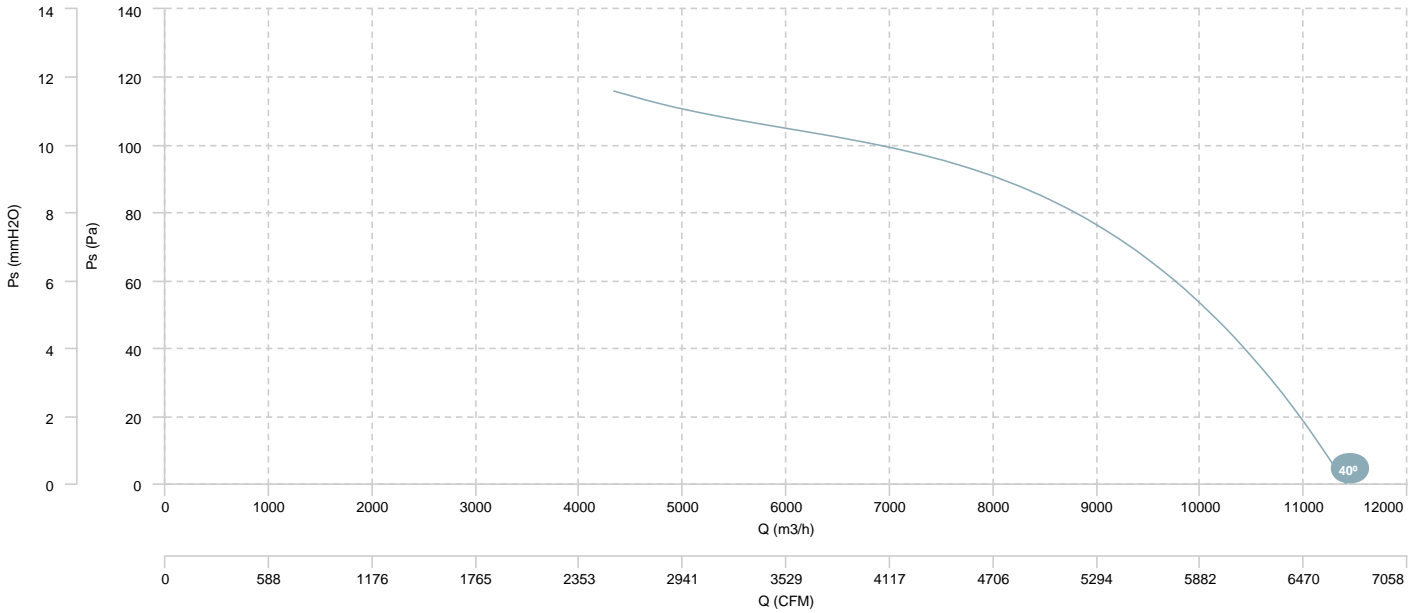

AIR FLOW - ABSORBED POWER

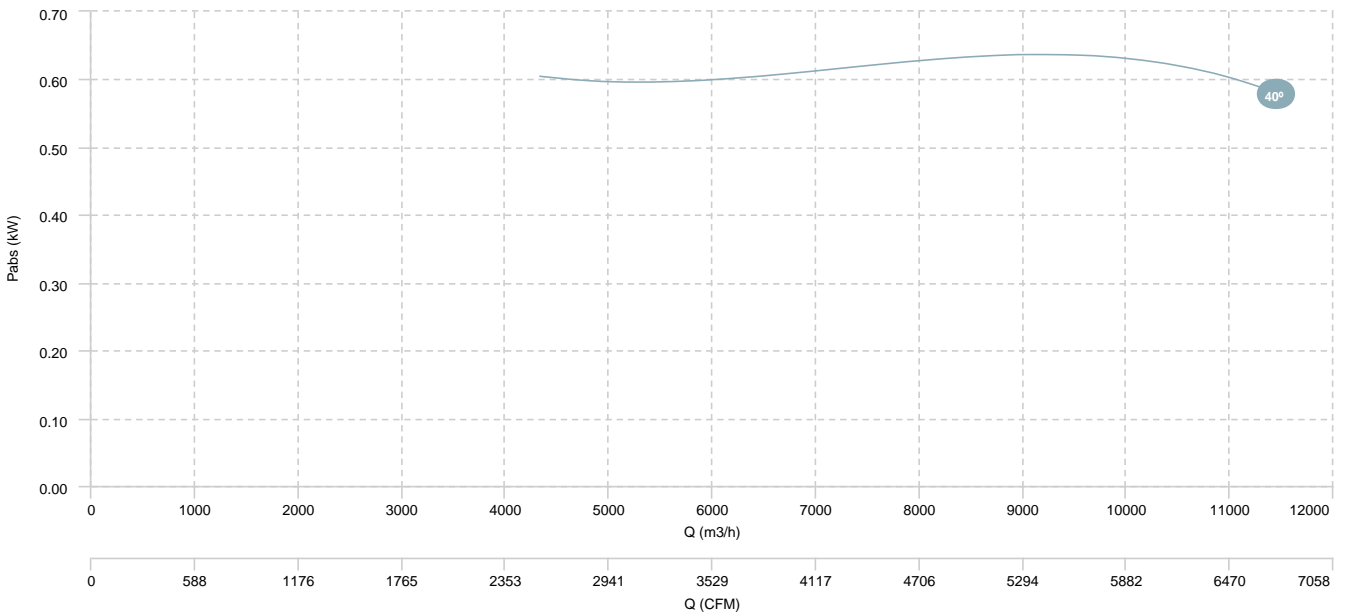

- HCF 63 T4/T8 0,8/0,2kW (A5:6) F400
 - HCF 63 T4/T8 1,2/0,3kW (A5:6) F400
 - HCF 63 T4/T8 1,6/0,4kW (A5:6) F400
- HCF 63 T4/T8 2,2/0,37kW (A5:6) F400

AIR FLOW - PRESSURE (4 poles)

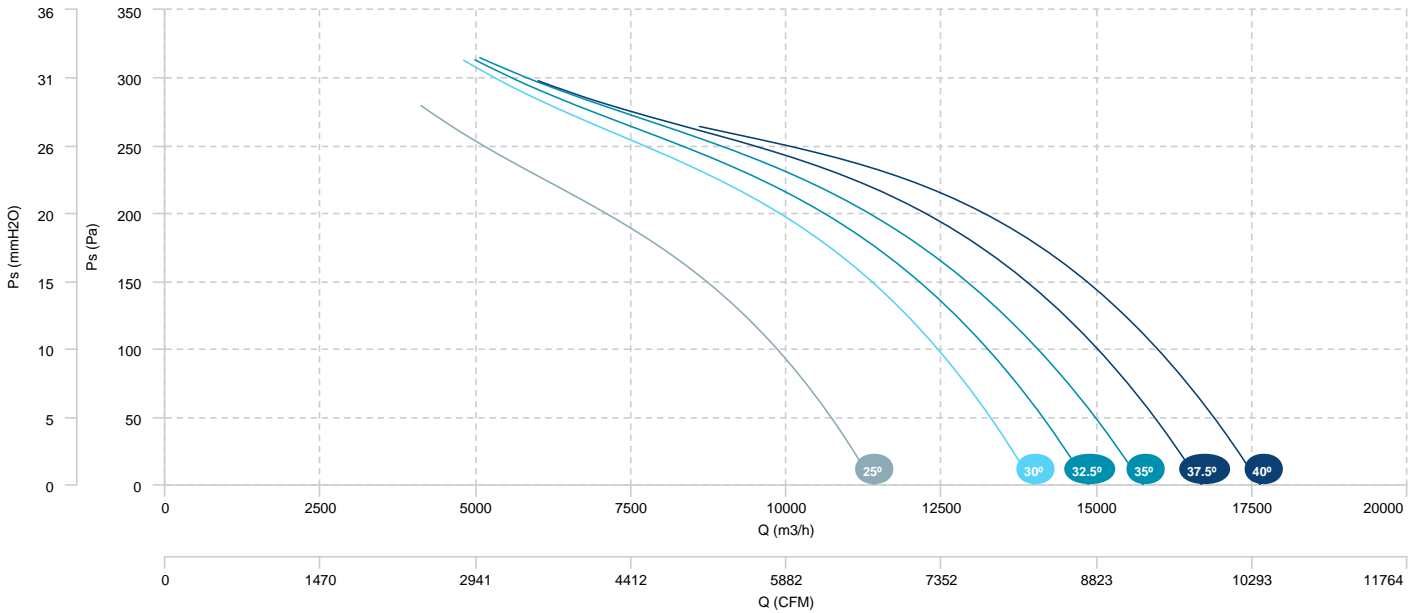

AIR FLOW - ABSORBED POWER (4 poles)

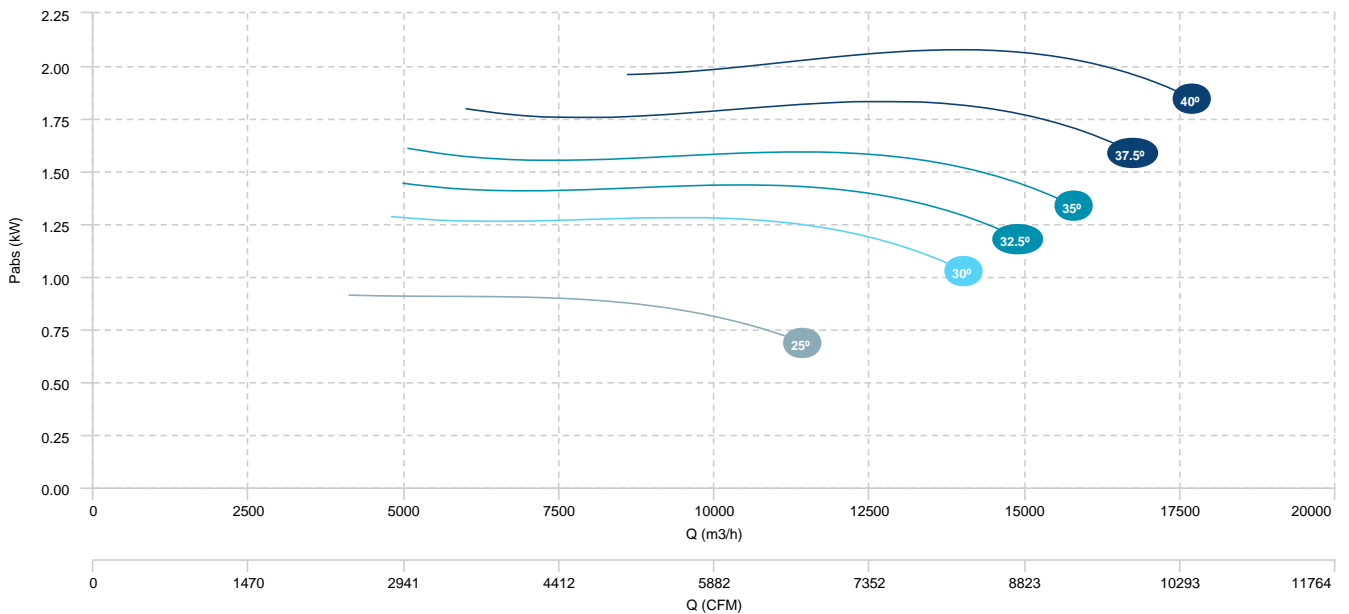

HCF 63 T4/T8 0,8/0,2kW (A5:6) F400
 HCF 63 T4/T8 2,2/0,37kW (A5:6) F400

HCF 63 T4/T8 1,2/0,3kW (A5:6) F400

HCF 63 T4/T8 1,6/0,4kW (A5:6) F400

AIR FLOW - PRESSURE (8 poles)

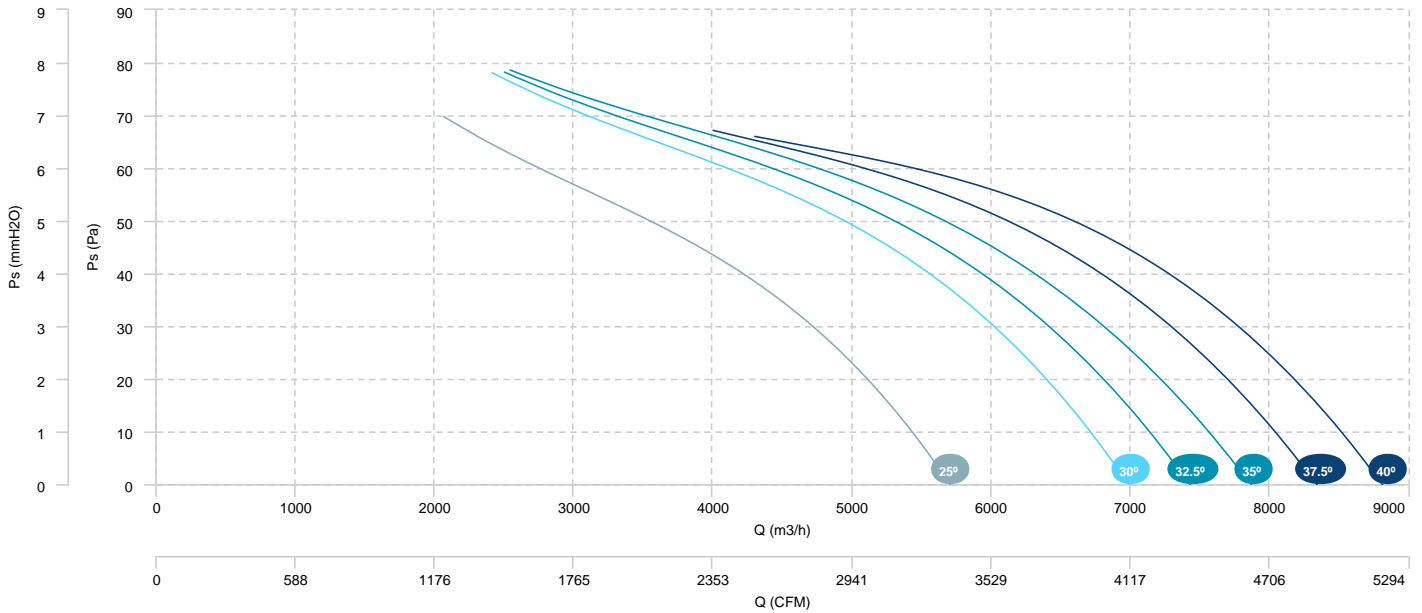

HCF 71 T4 0,75kW (A5:6) F400	HCF 71 T4 1,1kW (A5:6) F400	HCF 71 T4 1,5kW (A5:6) F400
HCF 71 T4 2,2kW (A5:6) F400	HCF 71 T4 3kW (A5:6) F400	

AIR FLOW - PRESSURE

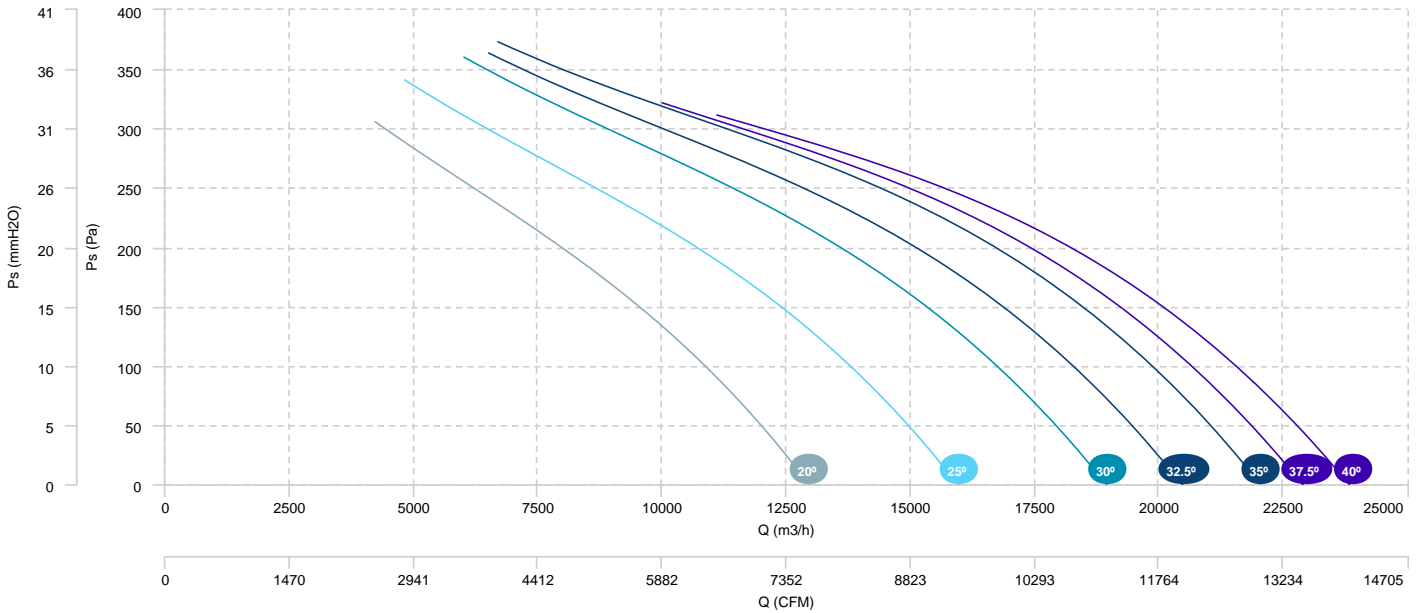

AIR FLOW - ABSORBED POWER

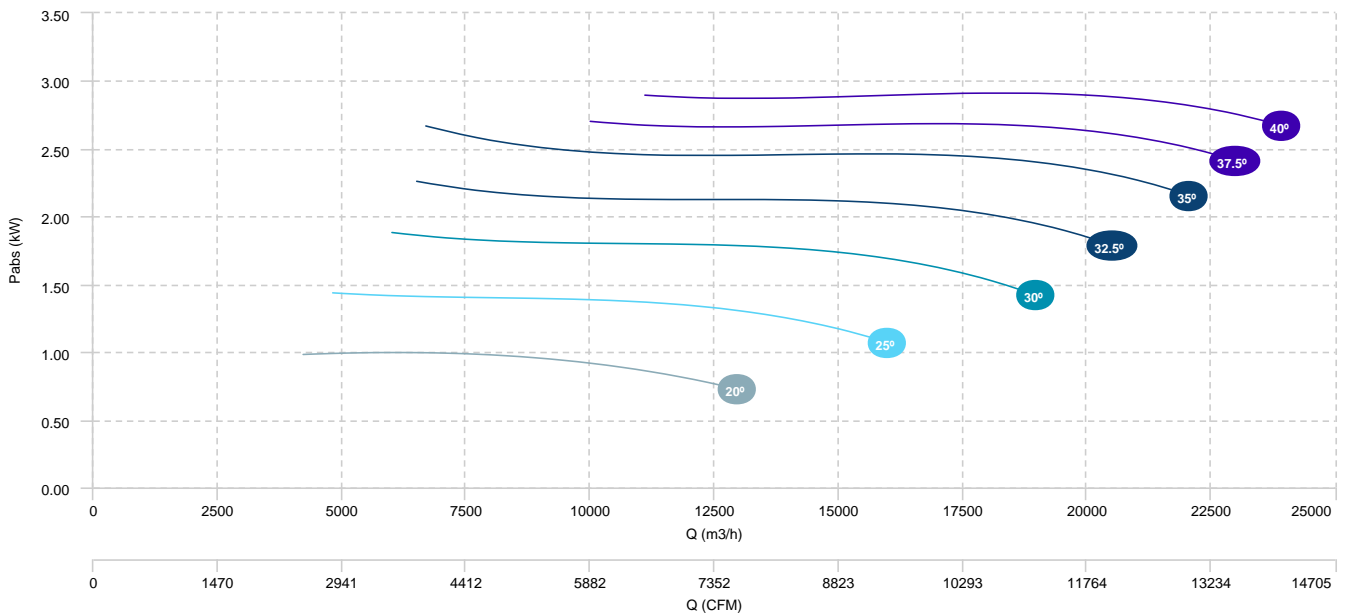

HCF 71 T6 0,75kW (A5:6) F400

AIR FLOW - PRESSURE

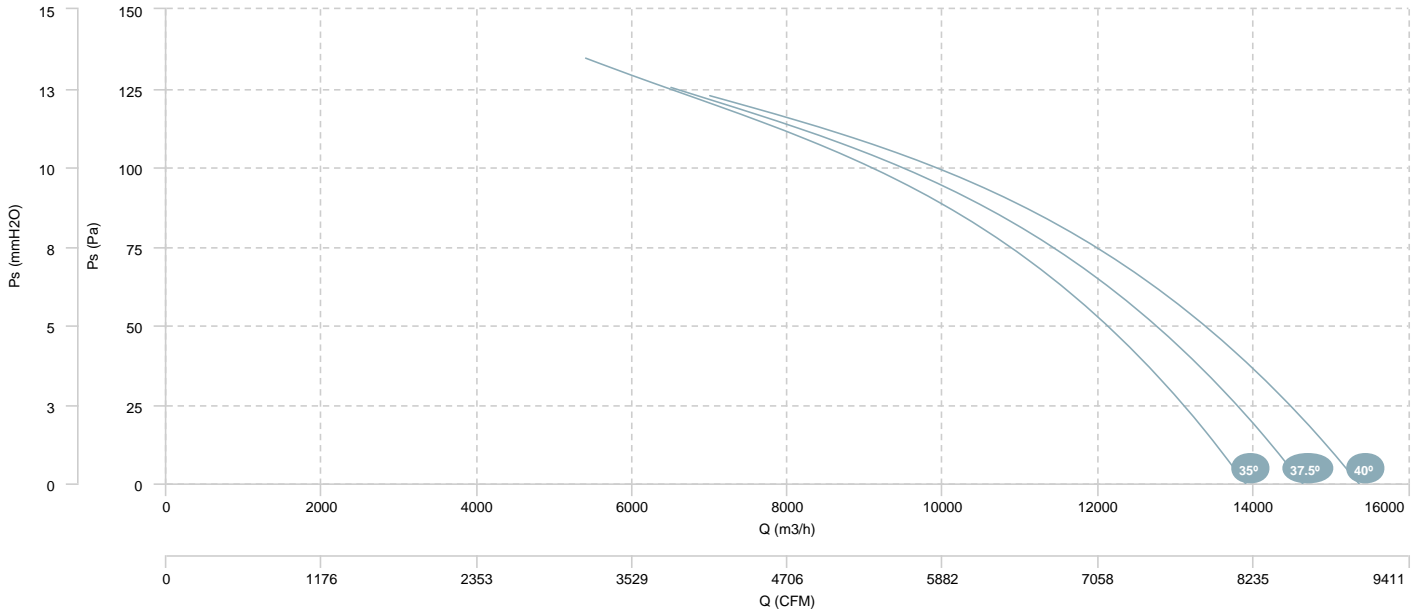

AIR FLOW - ABSORBED POWER

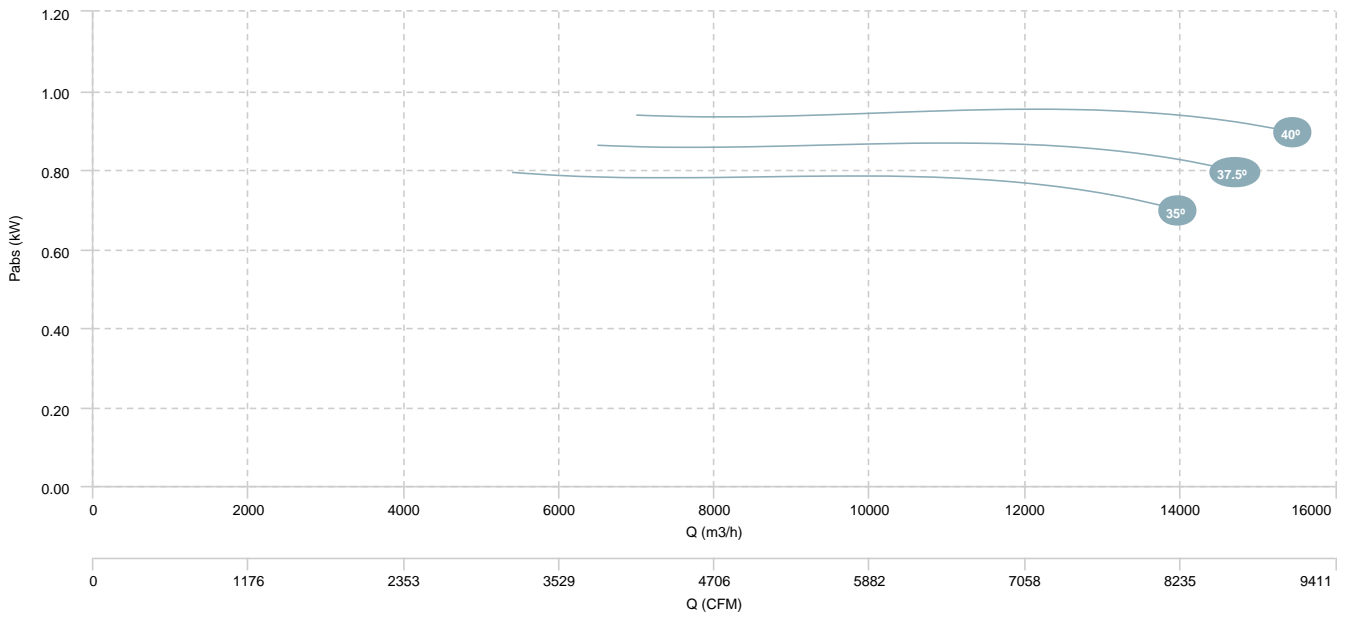

HCF 71 T4/T8 0,8/0,2kW (A5:6) F400	HCF 71 T4/T8 1,2/0,3kW (A5:6) F400	HCF 71 T4/T8 1,6/0,4kW (A5:6) F400
HCF 71 T4/T8 2,2/0,37kW (A5:6) F400	HCF 71 T4/T8 3/0,55kW (A5:6) F400	

AIR FLOW - PRESSURE (4 poles)

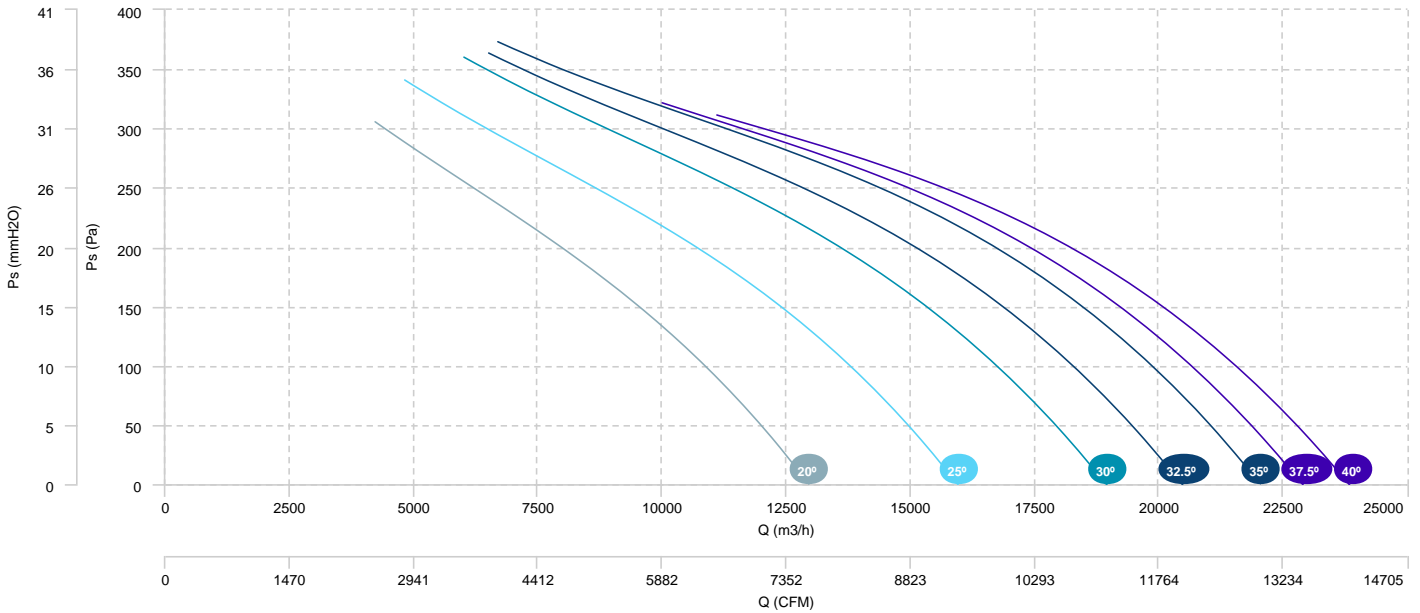

AIR FLOW - ABSORBED POWER (4 poles)

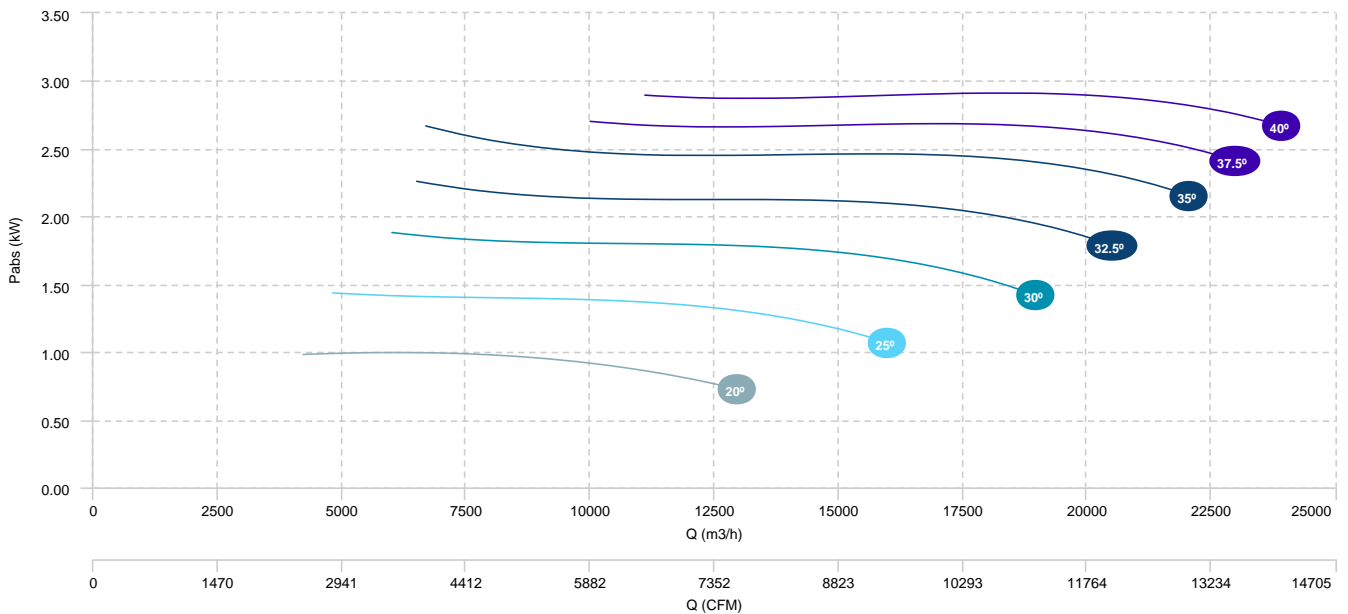

HCF 71 T4/T8 0,8/0,2kW (A5:6) F400	HCF 71 T4/T8 1,2/0,3kW (A5:6) F400	HCF 71 T4/T8 1,6/0,4kW (A5:6) F400
HCF 71 T4/T8 2,2/0,37kW (A5:6) F400	HCF 71 T4/T8 3/0,55kW (A5:6) F400	

AIR FLOW - PRESSURE (8 poles)

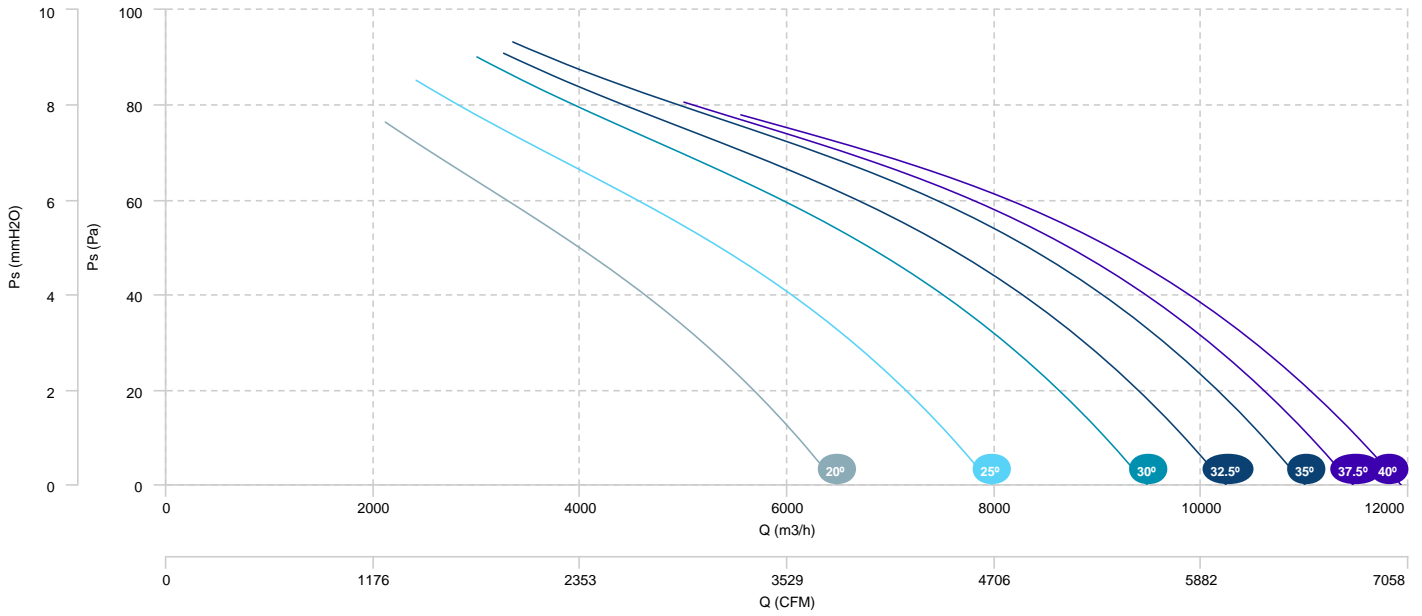

HCF 80 T4 3kW (A5:6) F400

HCF 80 T4 4kW (A5:6) F400

AIR FLOW - PRESSURE

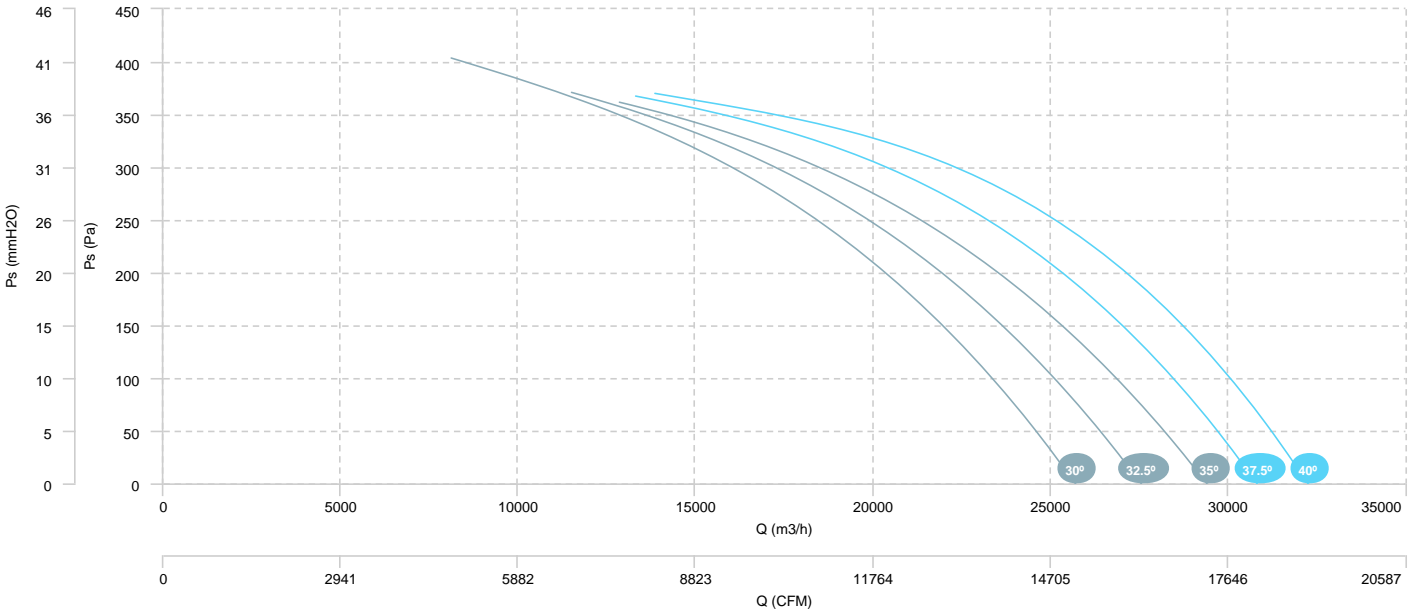

AIR FLOW - ABSORBED POWER

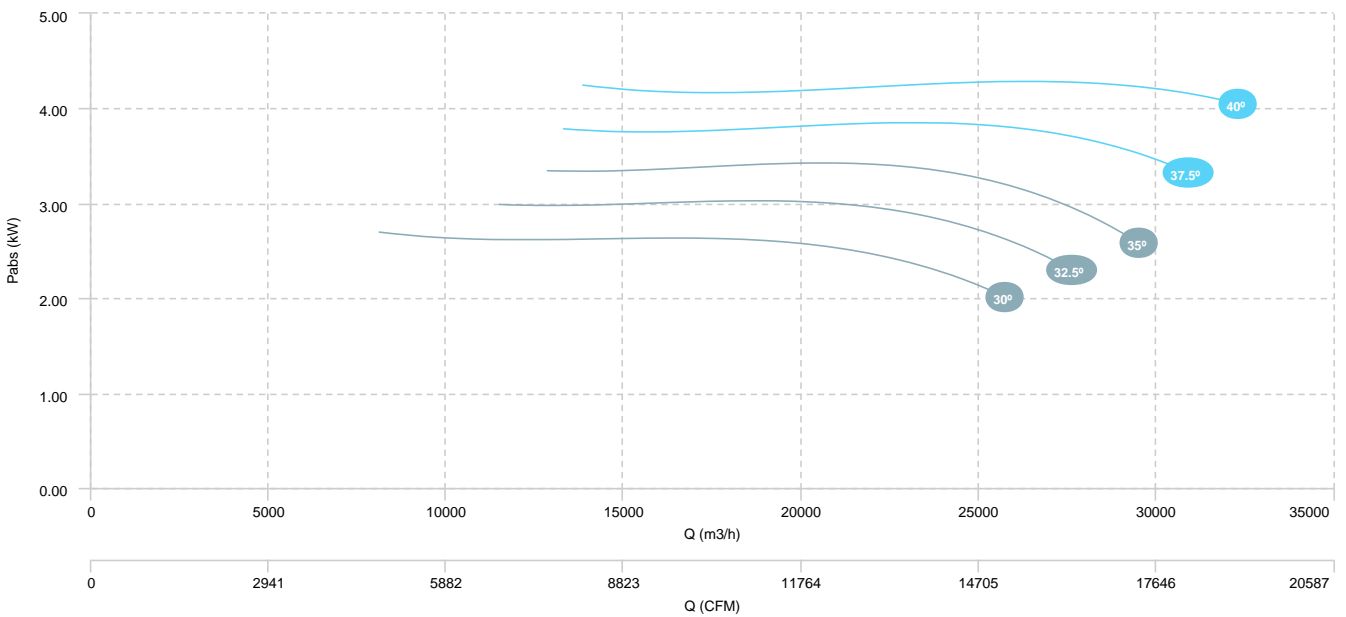

HCF 80 T6 0,75kW (A5:6) F400	HCF 80 T6 1,1kW (A5:6) F400	HCF 80 T6 1,5kW (A5:6) F400
HCF 80 T6 2,2kW (A5:6) F400		

AIR FLOW - PRESSURE

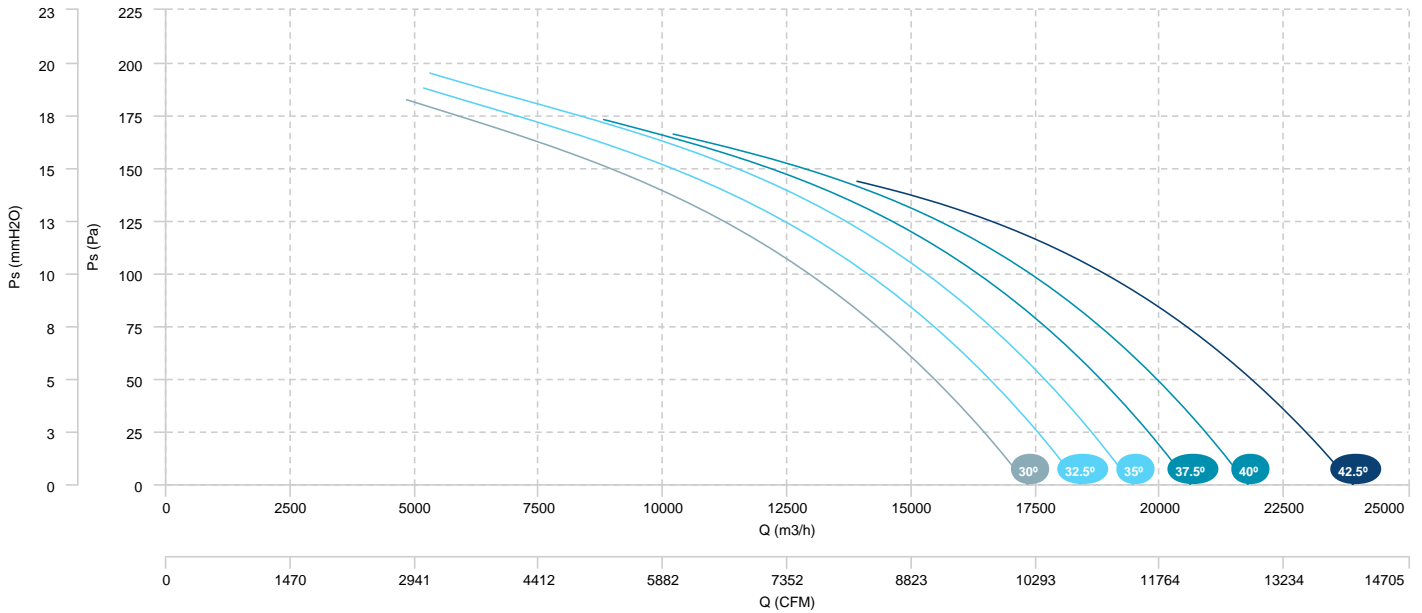

AIR FLOW - ABSORBED POWER

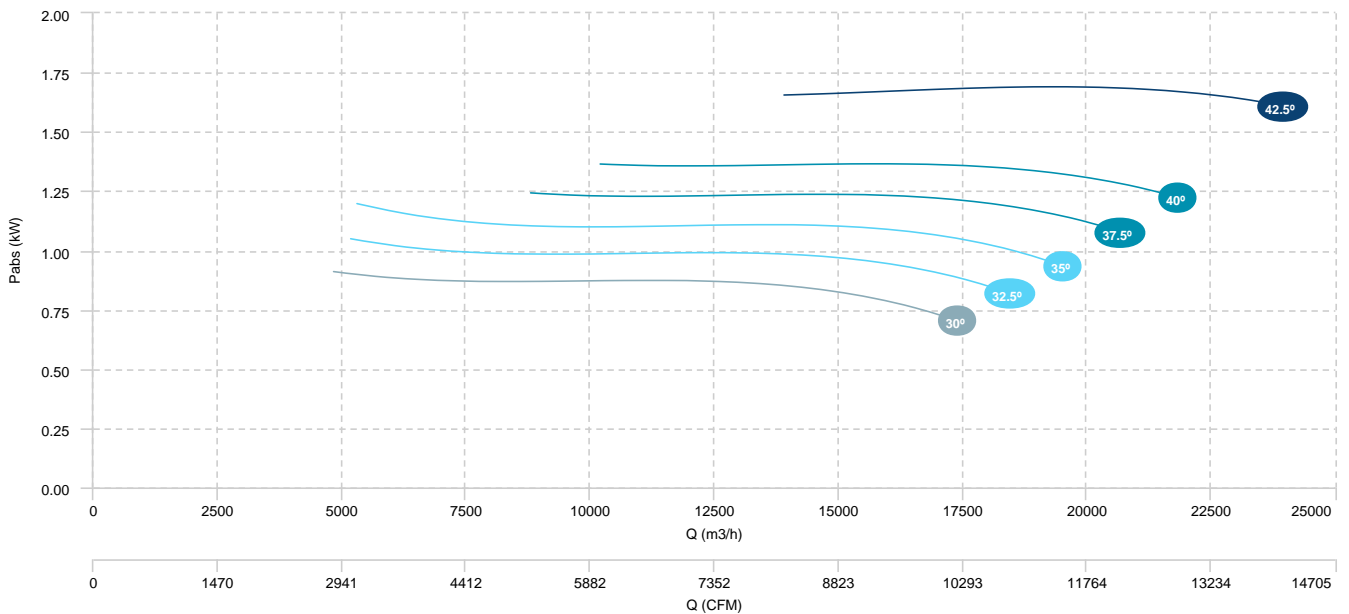

HCF 80 T4/T8 3/0,55kW (A5:6) F400

HCF 80 T4/T8 4/0,75kW (A5:6) F400

AIR FLOW - PRESSURE (4 poles)

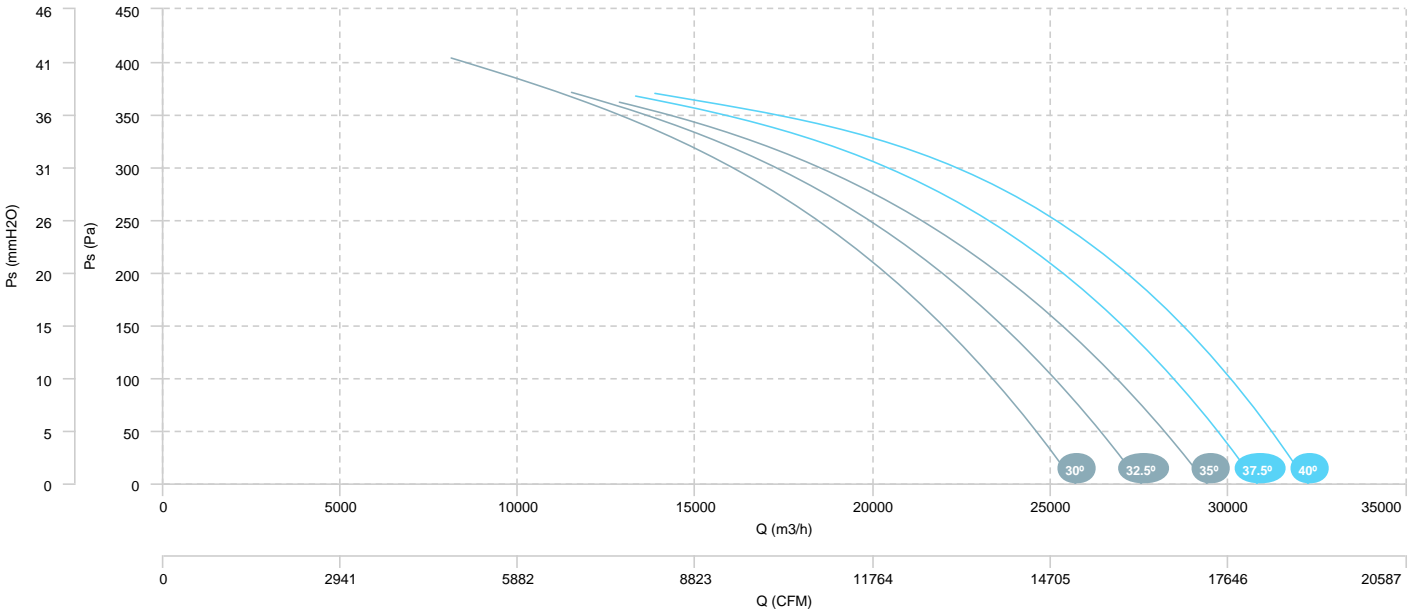

AIR FLOW - ABSORBED POWER (4 poles)

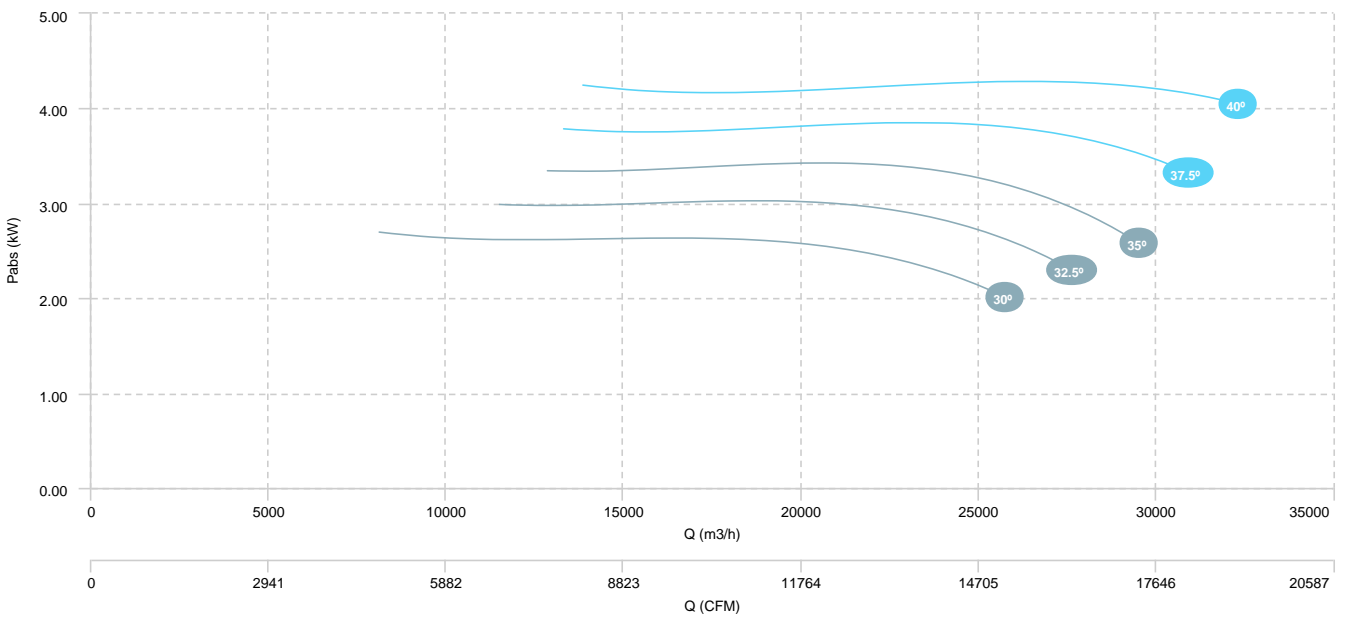

HCF 80 T4/T8 3/0,55kW (A5:6) F400

HCF 80 T4/T8 4/0,75kW (A5:6) F400

AIR FLOW - PRESSURE (8 poles)

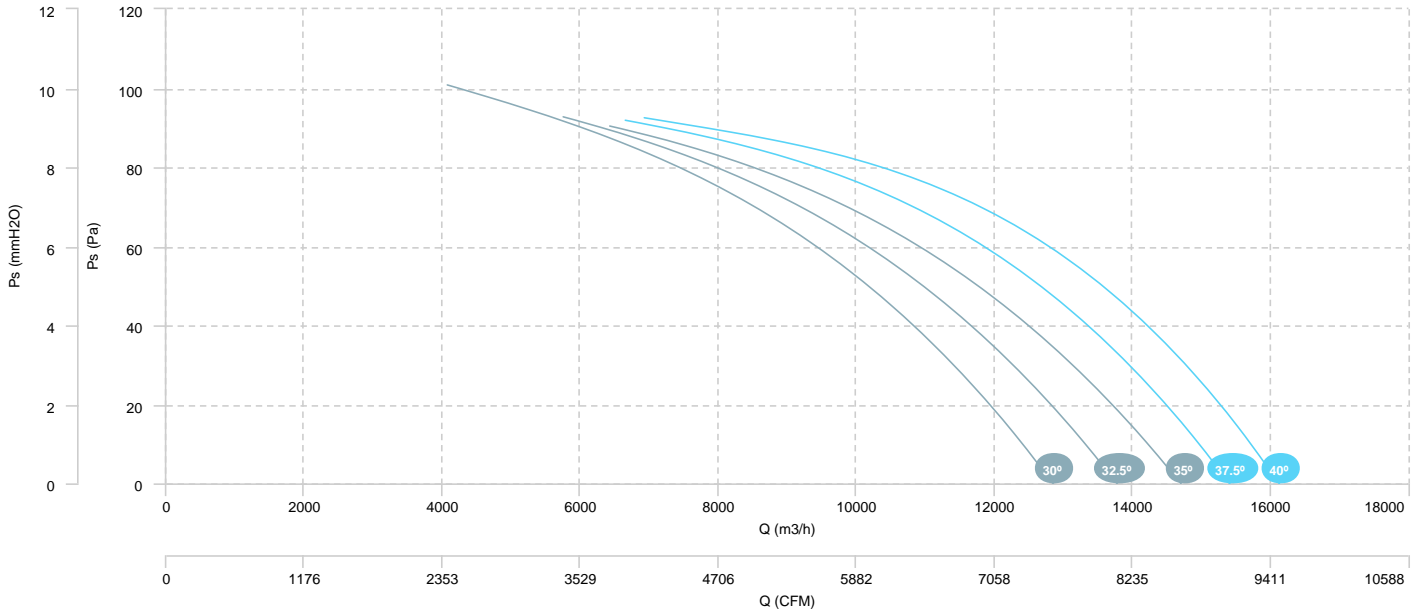

HCF 90 T4 5,5kW (A3:8) F400	HCF 90 T4 7,5kW (A3:8) F400	HCF 90 T4 11kW (A3:8) F400
HCF 90 T4 15kW (A3:8) F400		

AIR FLOW - PRESSURE

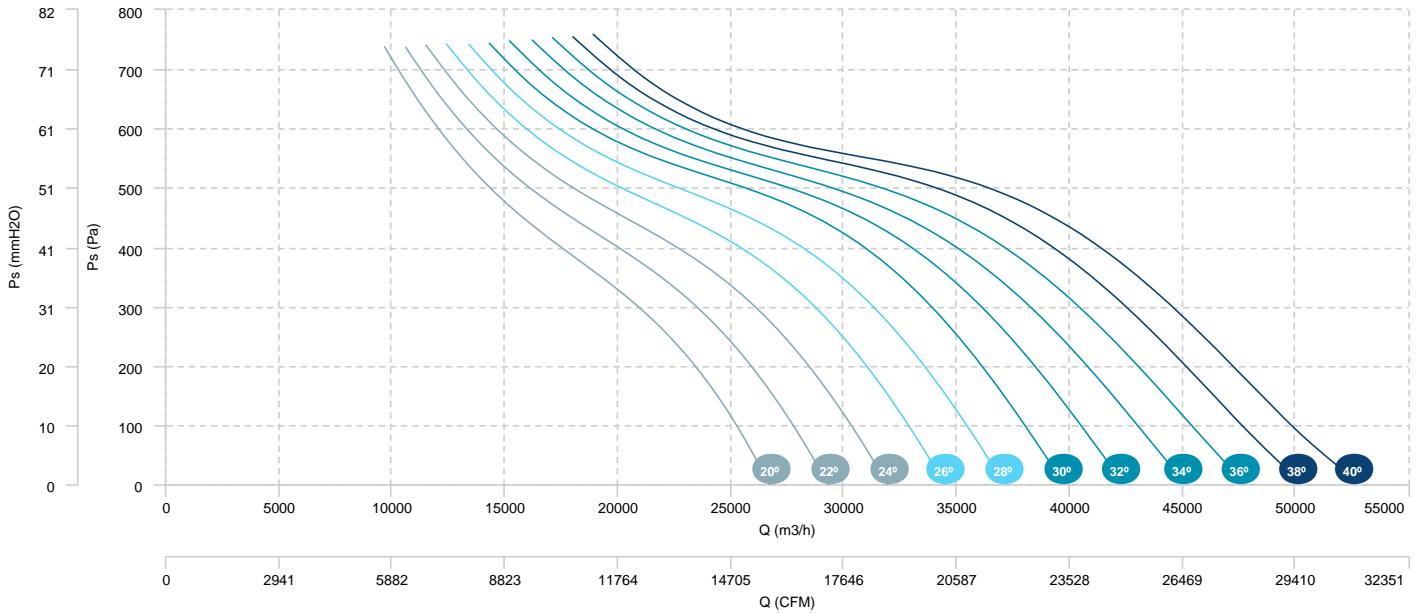

AIR FLOW - ABSORBED POWER

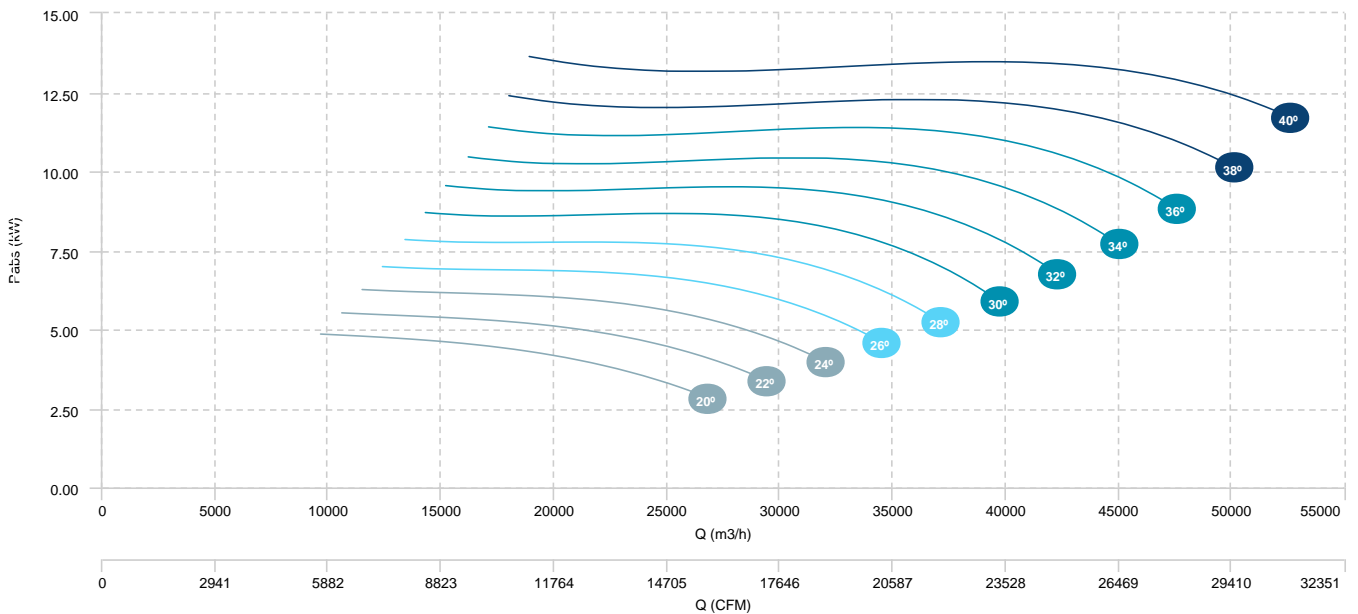

HCF 90 T4 3kW (A3:4) F400	HCF 90 T4 4kW (A3:4) F400	HCF 90 T4 5,5kW (A3:4) F400
HCF 90 T4 7,5kW (A3:4) F400	HCF 90 T4 11kW (A3:4) F400	

AIR FLOW - PRESSURE

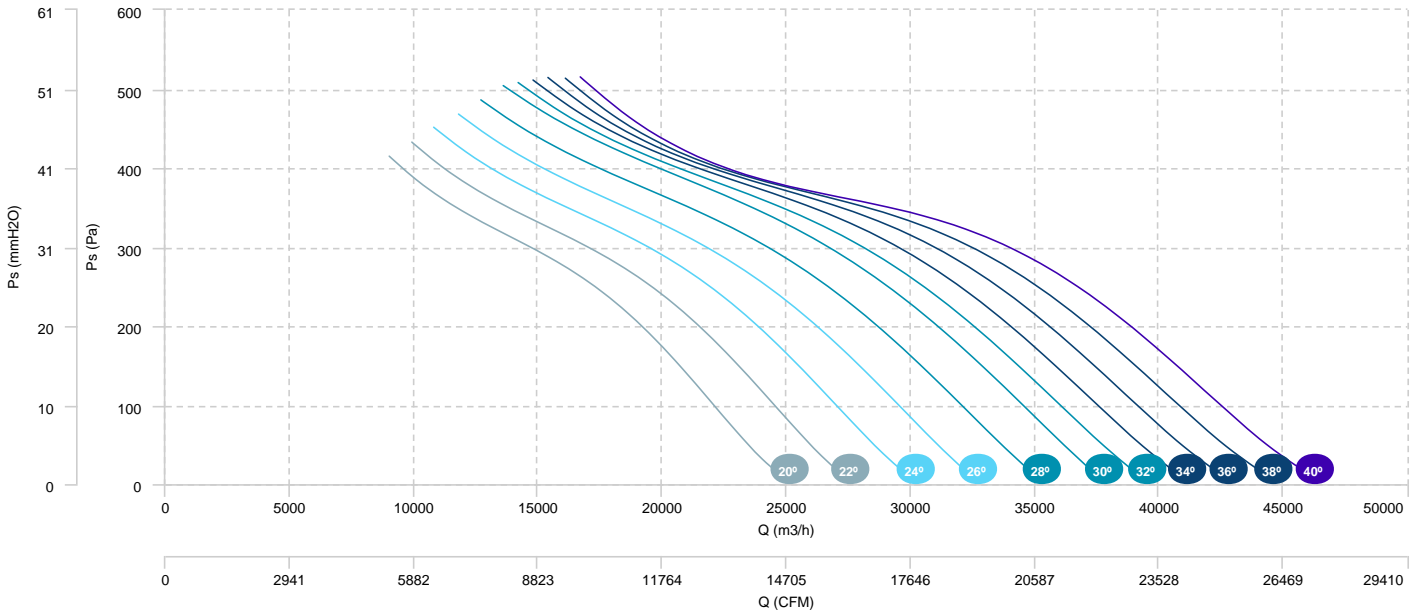

AIR FLOW - ABSORBED POWER

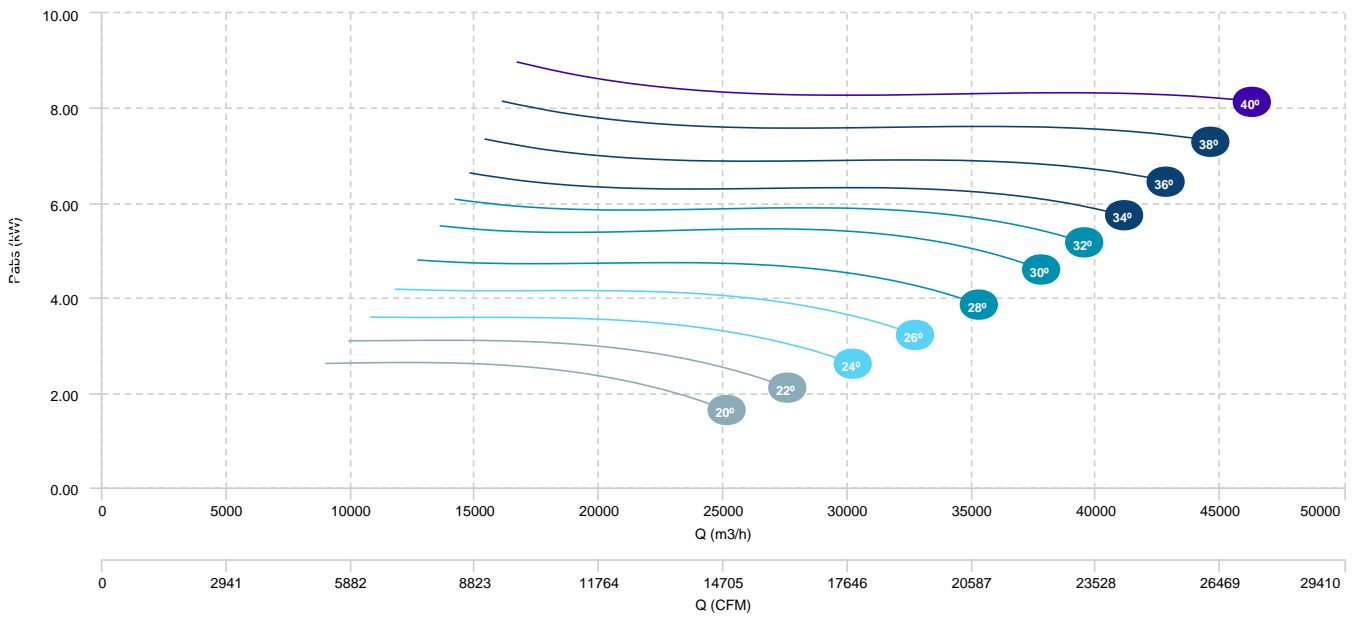

HCF 90 T6 1,5kW (A3:8) F400	HCF 90 T6 2,2kW (A3:8) F400	HCF 90 T6 3kW (A3:8) F400
HCF 90 T6 4kW (A3:8) F400		

AIR FLOW - PRESSURE

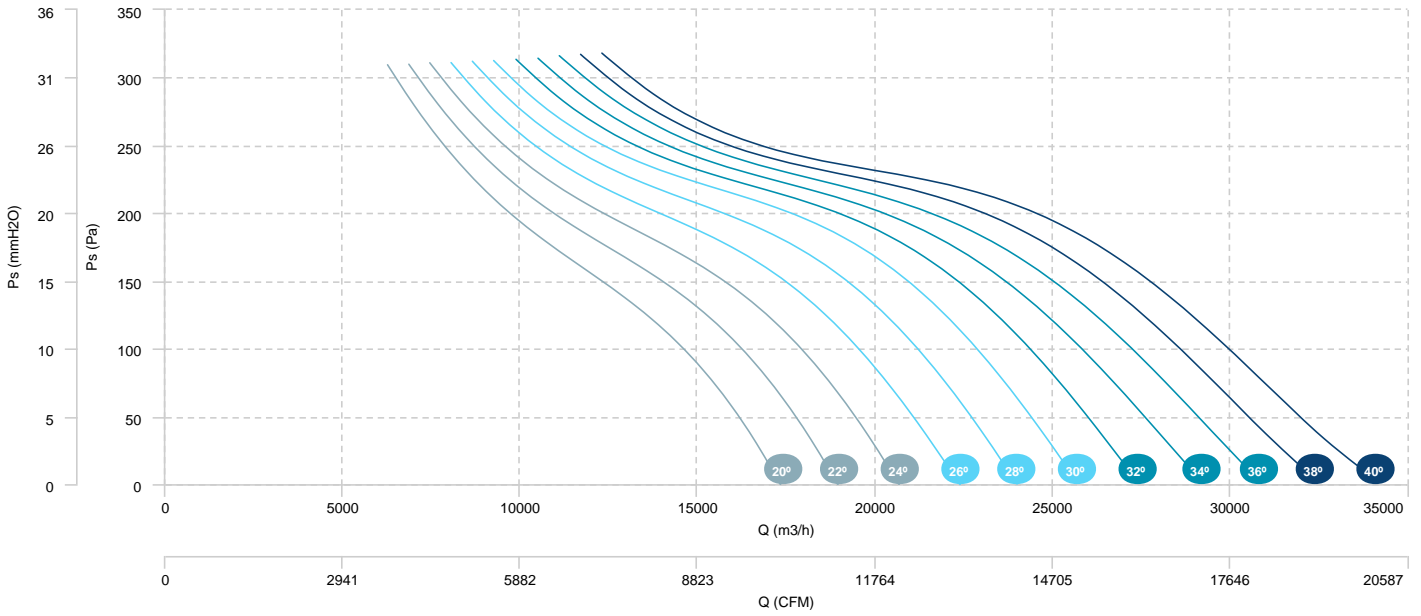

AIR FLOW - ABSORBED POWER

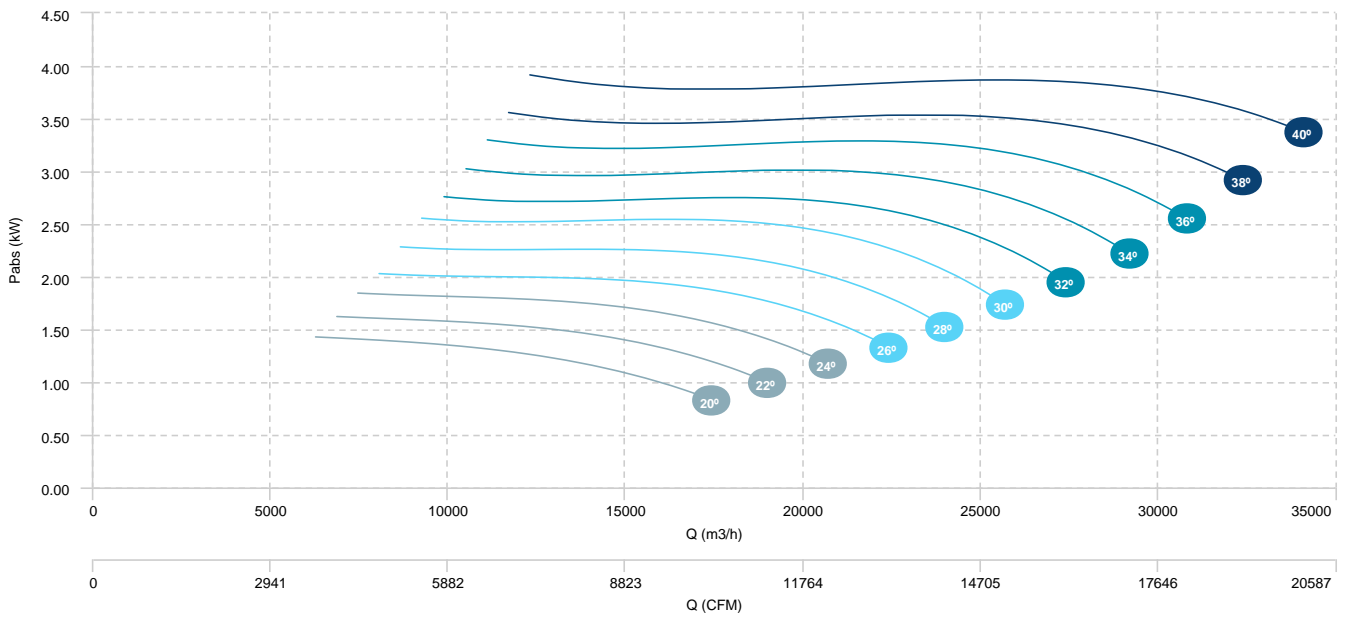

HCF 90 T6 1,5kW (A3:4) F400

HCF 90 T6 2,2kW (A3:4) F400

AIR FLOW - PRESSURE

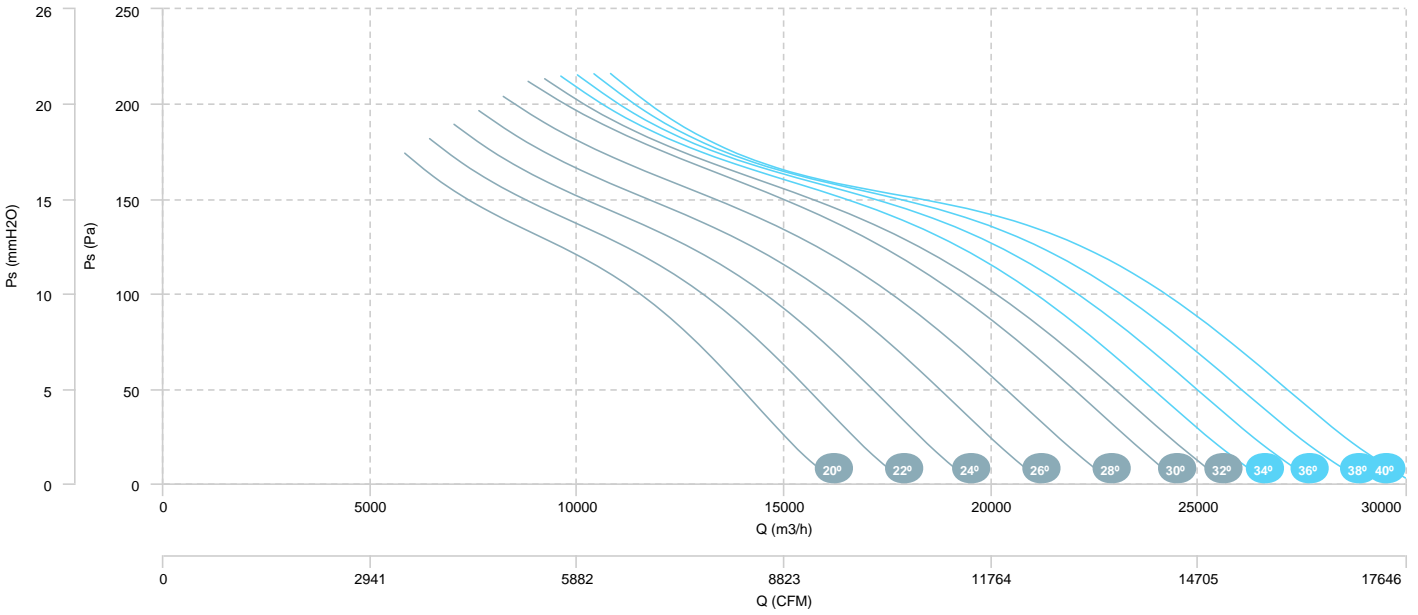

AIR FLOW - ABSORBED POWER

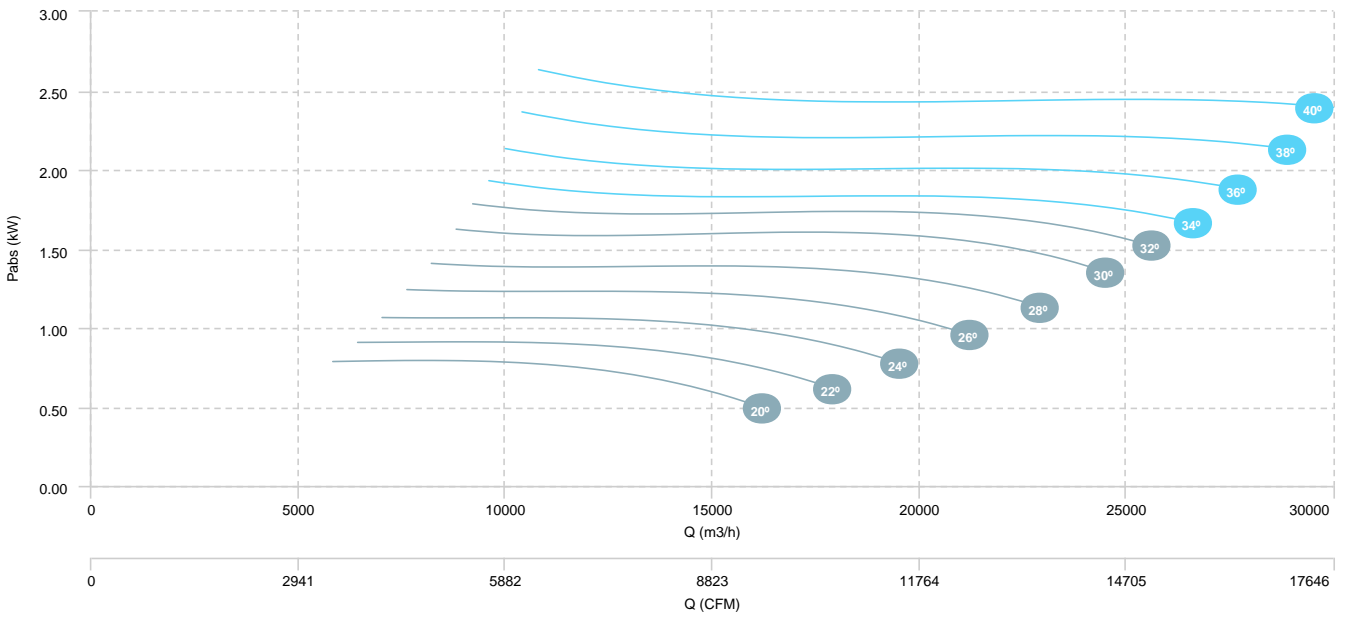

HCF 90 T4/T8 5,5/1,1kW (A3:8) F400	HCF 90 T4/T8 7,5/1,5kW (A3:8) F400	HCF 90 T4/T8 11/3kW (A3:8) F400
HCF 90 T4/T8 14/3,5kW (A3:8) F400		

AIR FLOW - PRESSURE (4 poles)

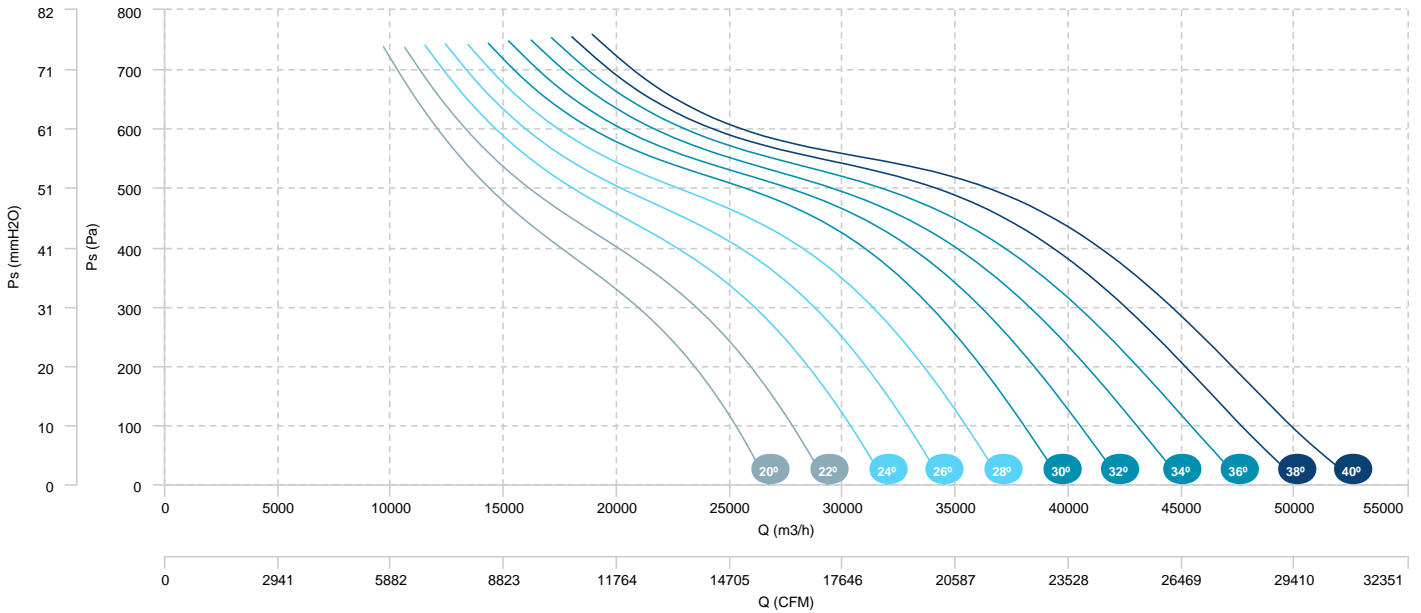

AIR FLOW - ABSORBED POWER (4 poles)

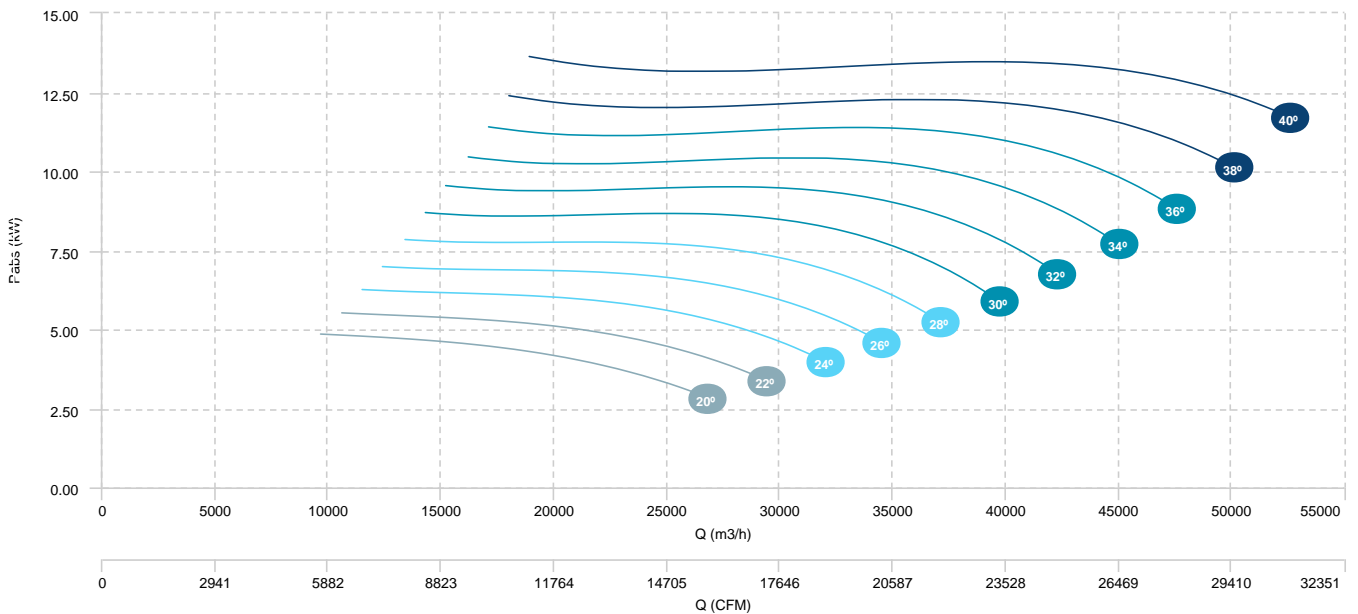

- HCF 90 T4/T8 5,5/1,1kW (A3:8) F400
 - HCF 90 T4/T8 7,5/1,5kW (A3:8) F400
 - HCF 90 T4/T8 11/3kW (A3:8) F400
- HCF 90 T4/T8 14/3,5kW (A3:8) F400

AIR FLOW - PRESSURE (8 poles)

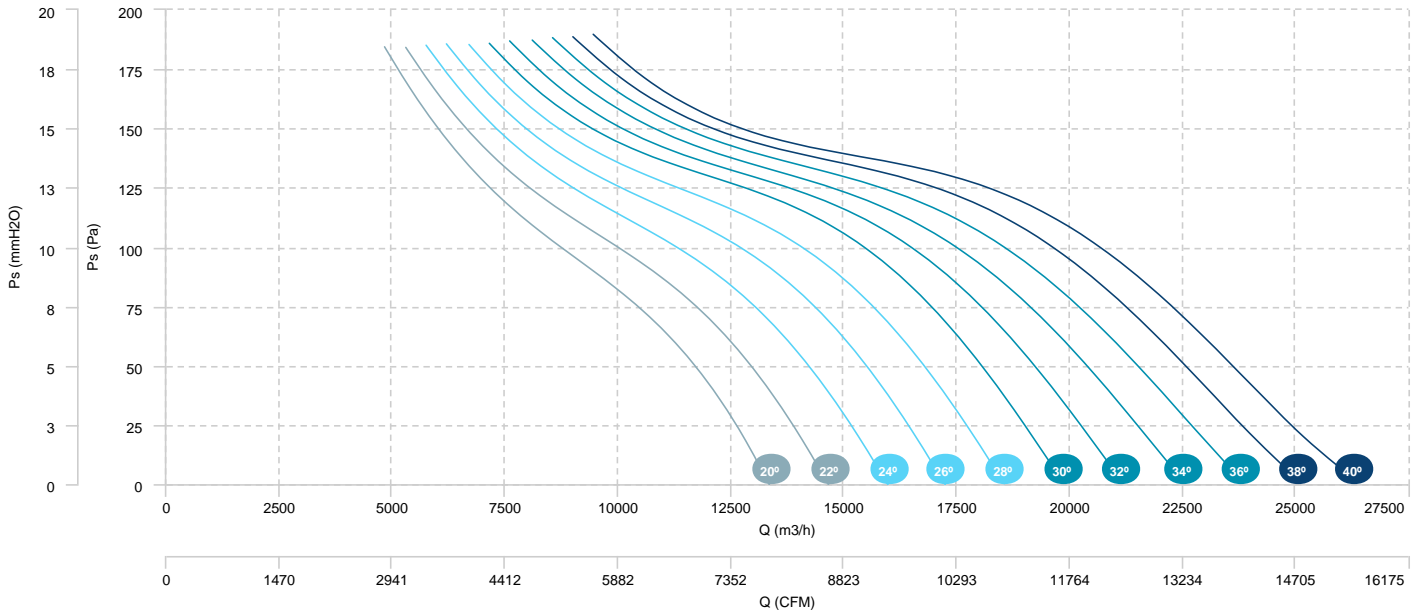

HCF 90 T4/T8 2,8/0,7kW (A3:4) F400	HCF 90 T4/T8 4/0,75kW (A3:4) F400	HCF 90 T4/T8 5,5/1,1kW (A3:4) F400
HCF 90 T4/T8 7,5/1,5kW (A3:4) F400	HCF 90 T4/T8 11/3kW (A3:4) F400	

AIR FLOW - PRESSURE (4 poles)

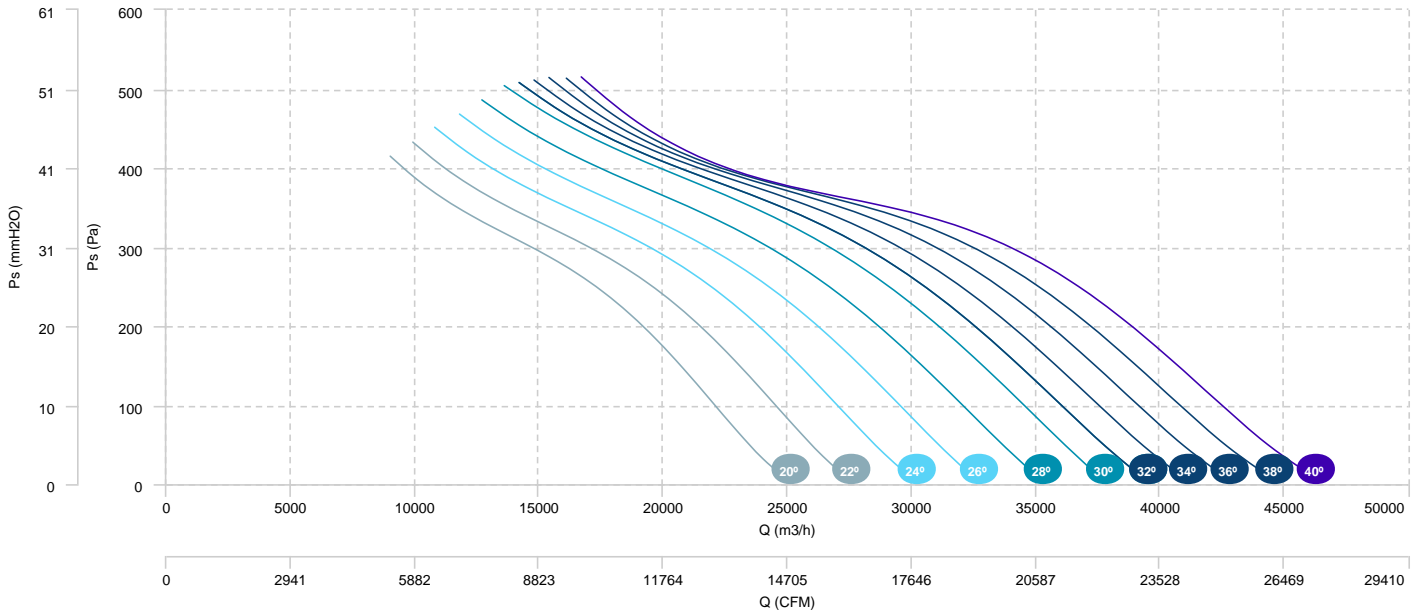

AIR FLOW - ABSORBED POWER (4 poles)

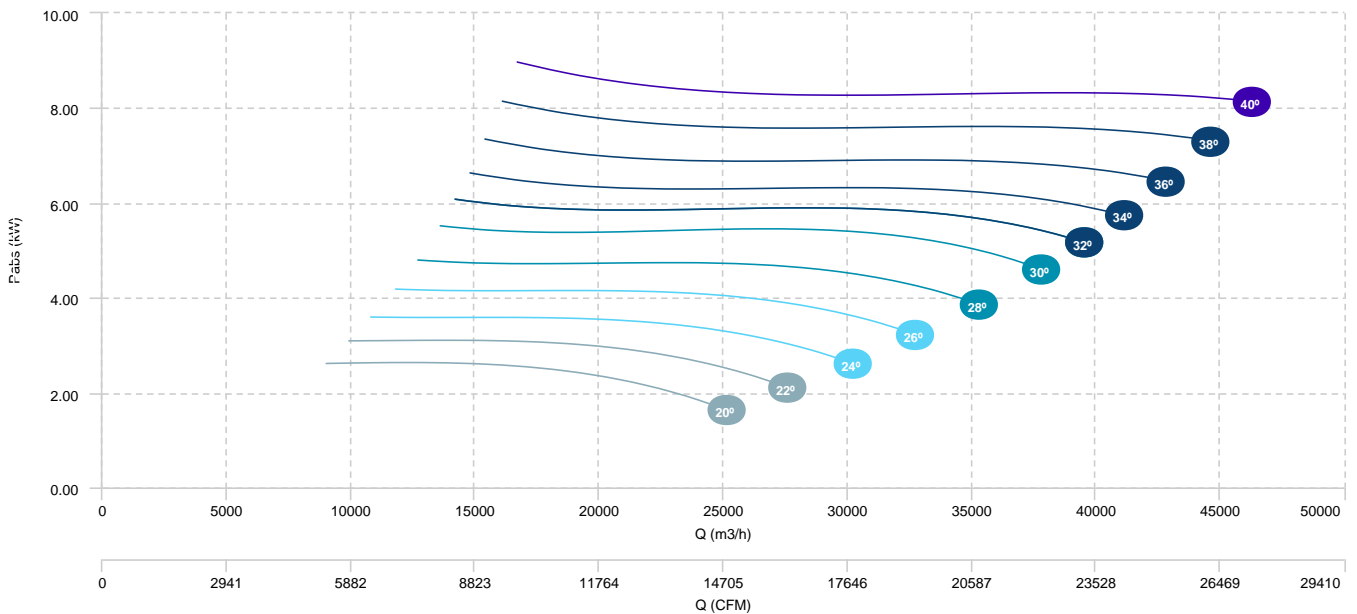

HCF 90 T4/T8 2,8/0,7kW (A3:4) F400	HCF 90 T4/T8 4/0,75kW (A3:4) F400	HCF 90 T4/T8 5,5/1,1kW (A3:4) F400
HCF 90 T4/T8 7,5/1,5kW (A3:4) F400	HCF 90 T4/T8 11/3kW (A3:4) F400	

AIR FLOW - PRESSURE (8 poles)

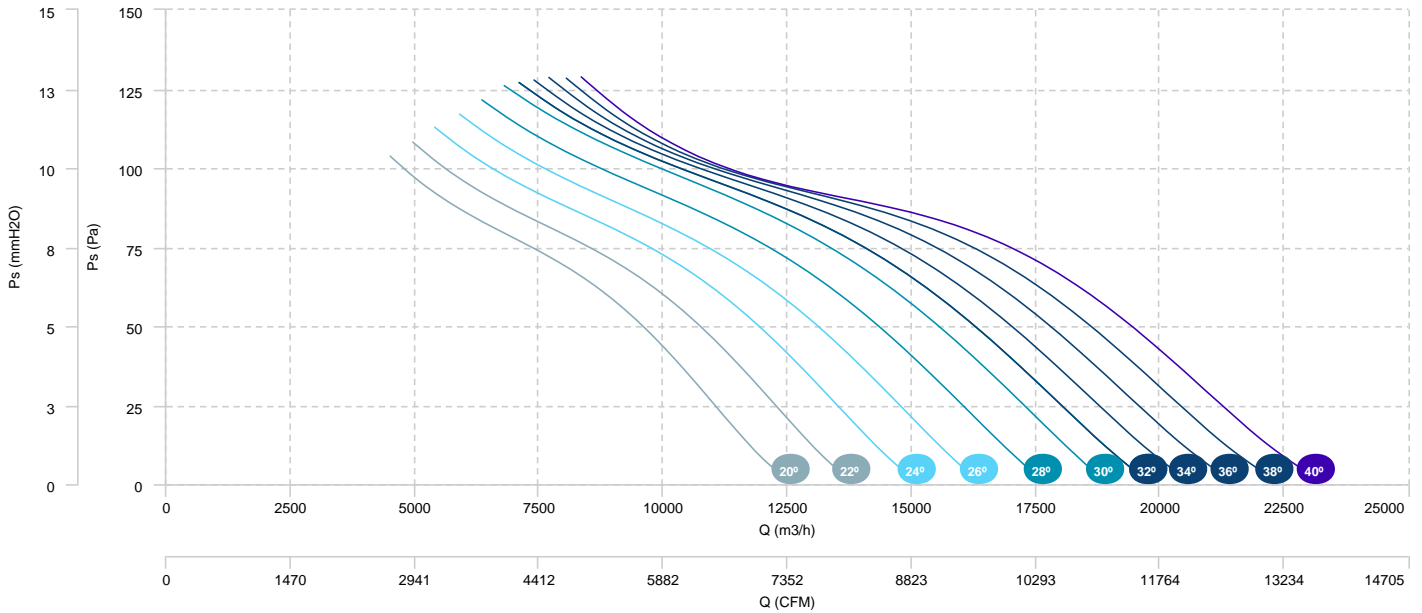

HCF 100 T4 7,5kW (A3:8) F400	HCF 100 T4 11kW (A3:8) F400	HCF 100 T4 15kW (A3:8) F400
HCF 100 T4 18,5kW (A3:8) F400	HCF 100 T4 22kW (A3:8) F400	

AIR FLOW - PRESSURE

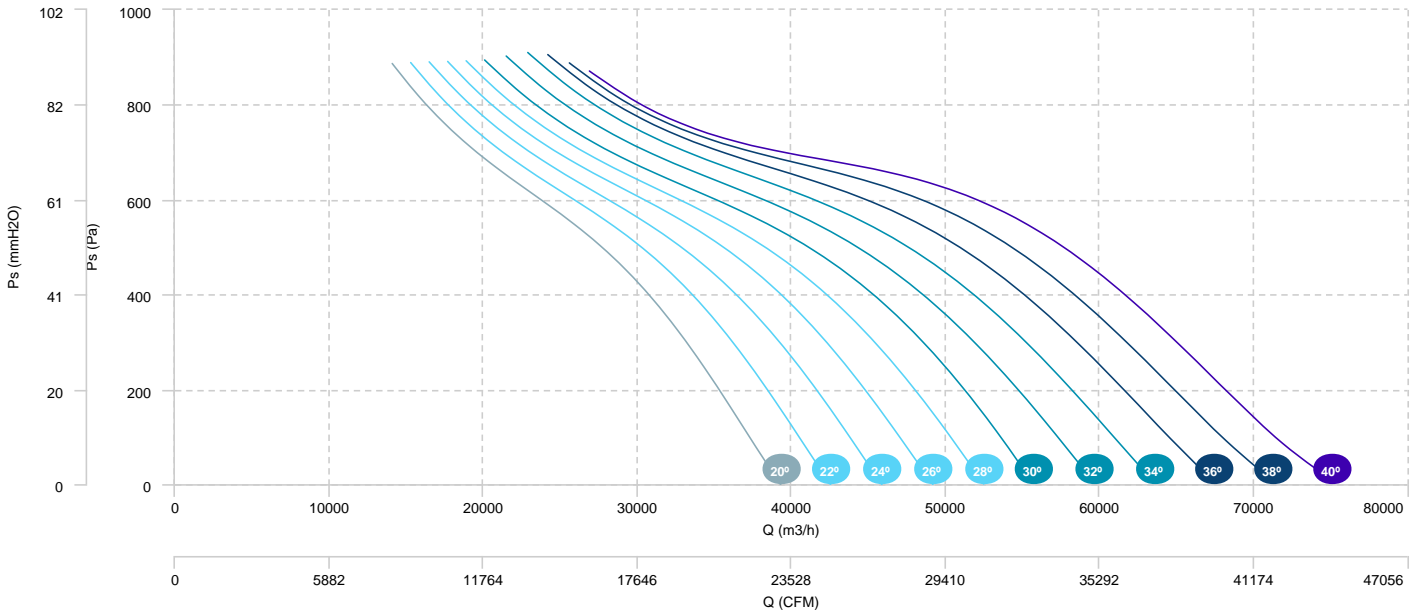

AIR FLOW - ABSORBED POWER

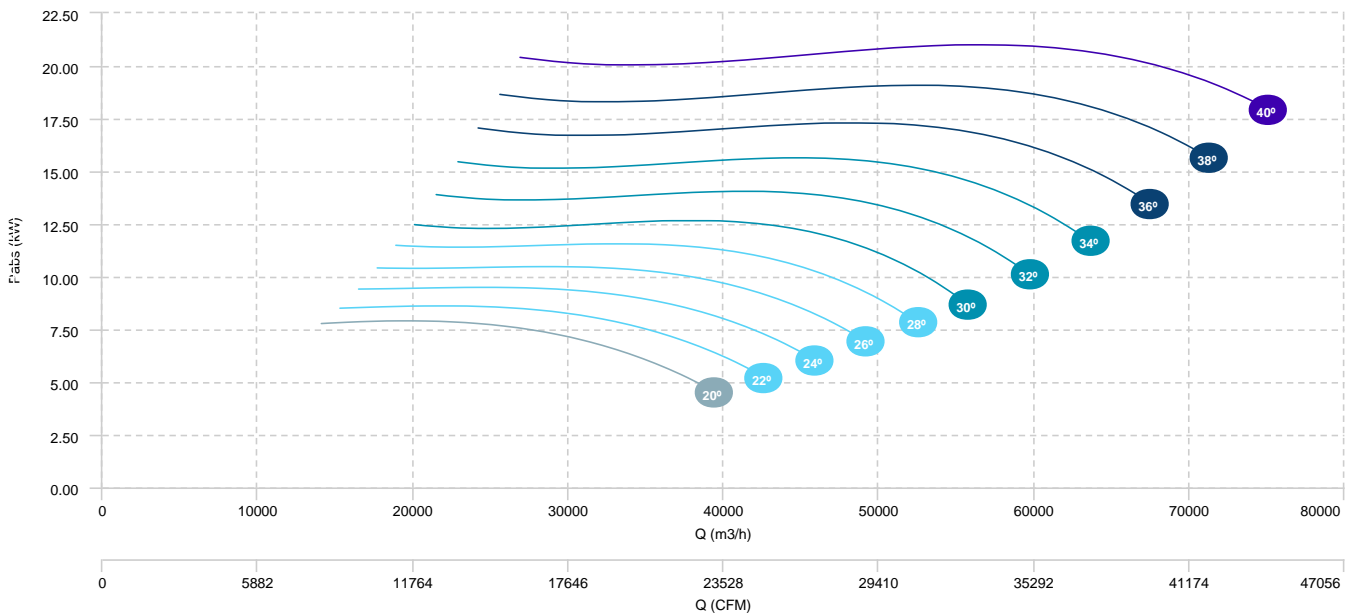

HCF 100 T4 5,5kW (A3:4) F400	HCF 100 T4 7,5kW (A3:4) F400	HCF 100 T4 11kW (A3:4) F400
HCF 100 T4 15kW (A3:4) F400		

AIR FLOW - PRESSURE

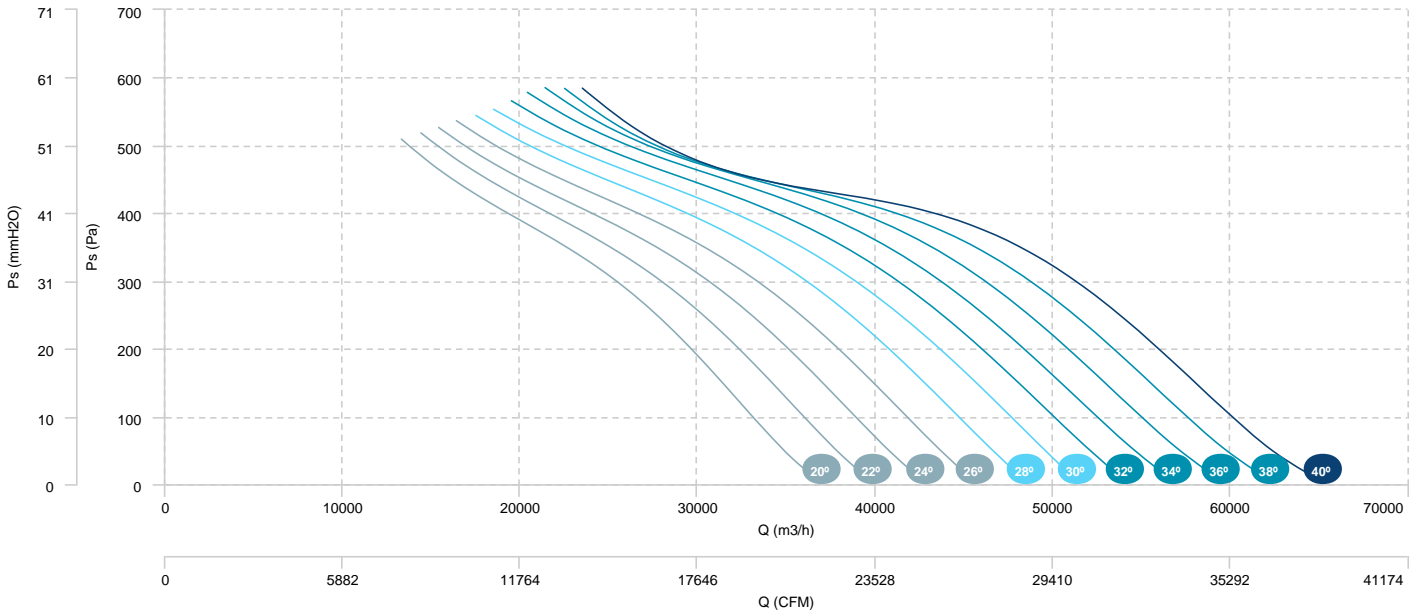

AIR FLOW - ABSORBED POWER

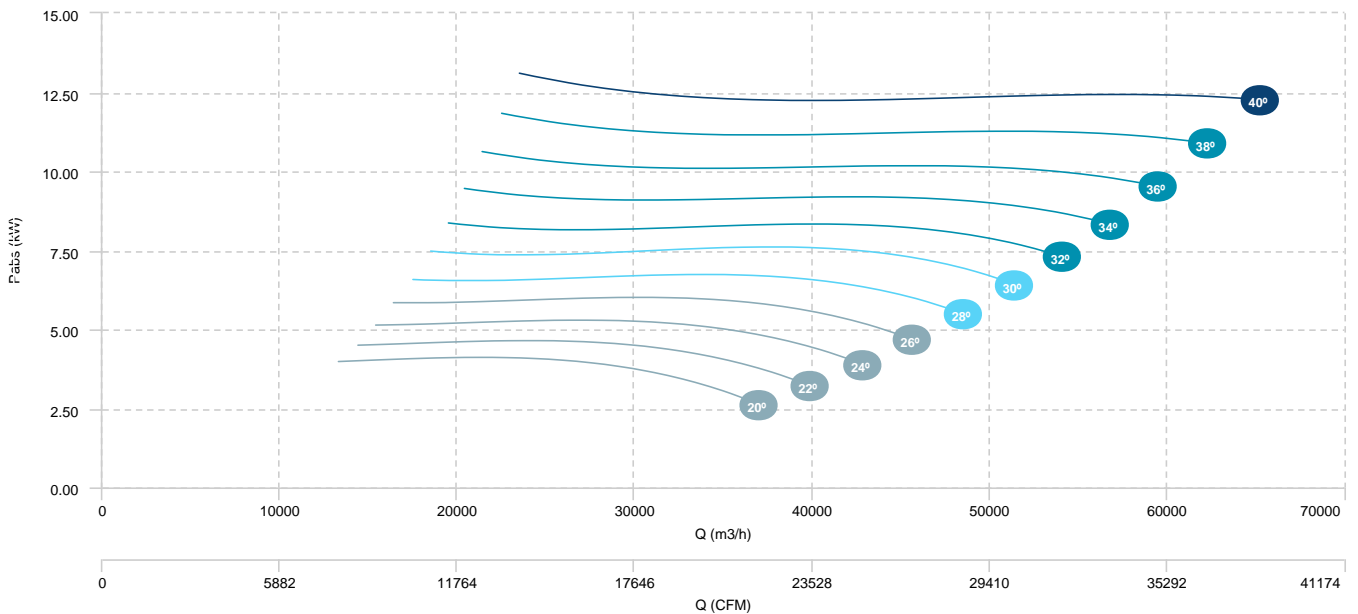

HCF 100 T6 2,2kW (A3:8) F400	HCF 100 T6 3kW (A3:8) F400	HCF 100 T6 4kW (A3:8) F400
HCF 100 T6 5,5kW (A3:8) F400		

AIR FLOW - PRESSURE

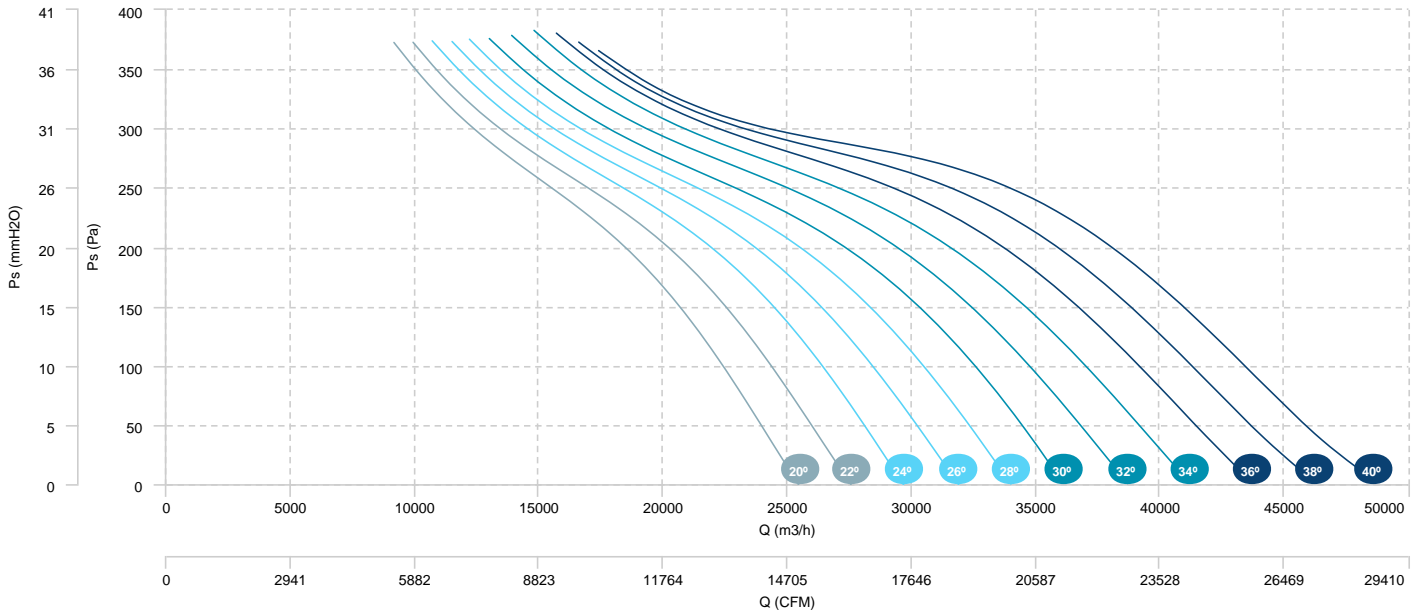

AIR FLOW - ABSORBED POWER

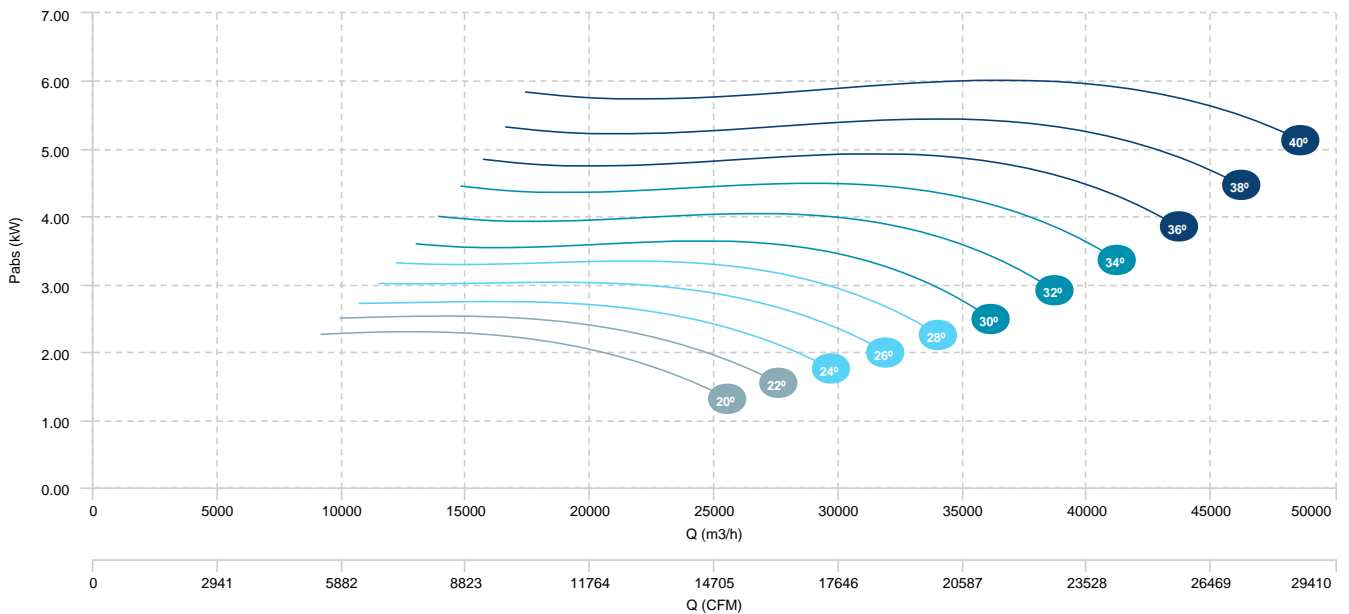

- HCF 100 T6 1,5kW (A3:4) F400
 - HCF 100 T6 2,2kW (A3:4) F400
 - HCF 100 T6 3kW (A3:4) F400
- HCF 100 T6 4kW (A3:4) F400

AIR FLOW - PRESSURE

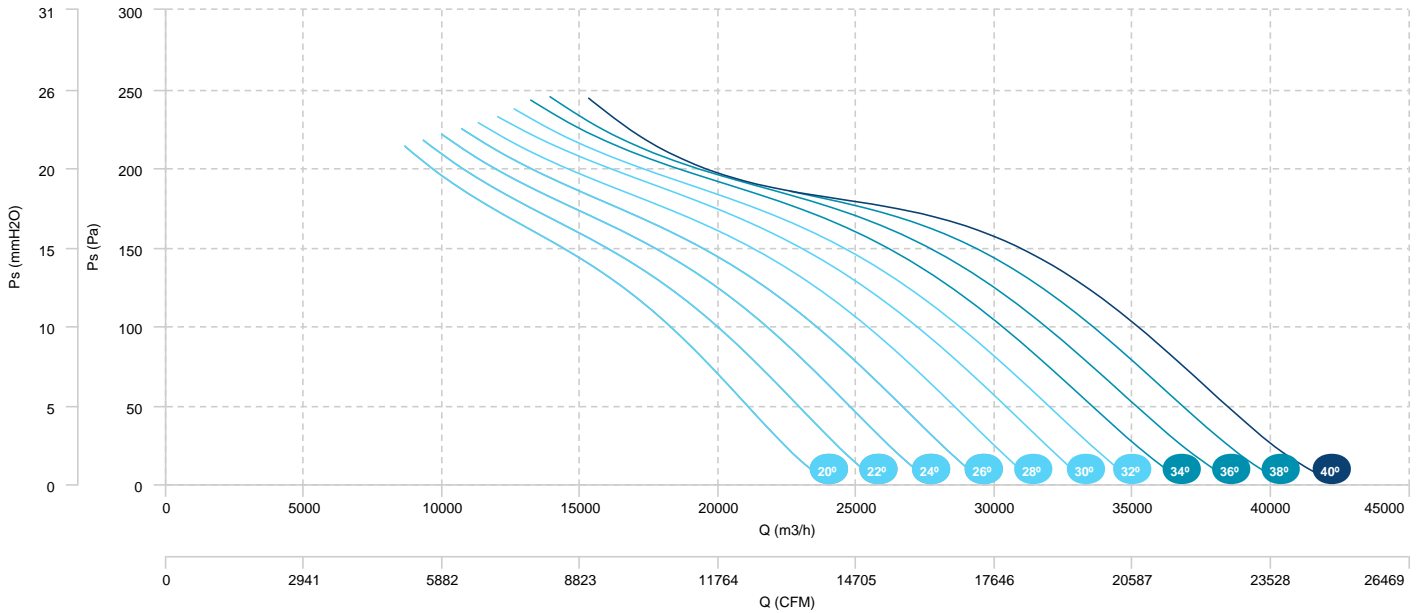

AIR FLOW - ABSORBED POWER

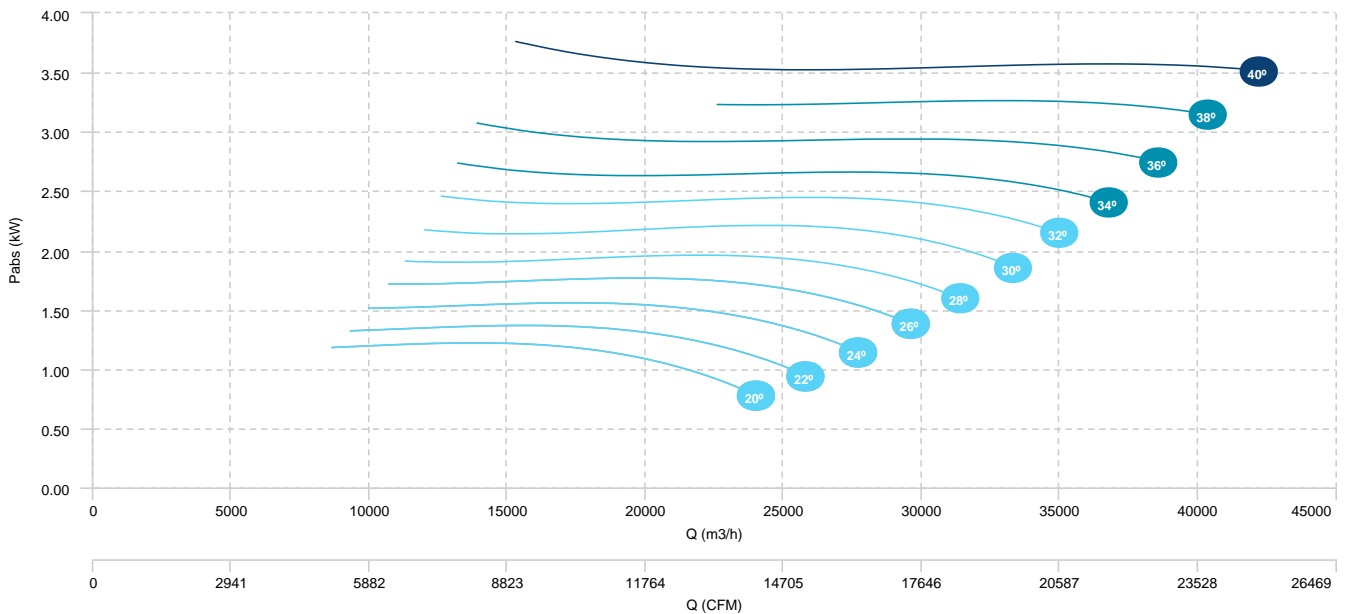

HCF 100 T4/T8 7,5/1,5kW (A3:8) F400	HCF 100 T4/T8 11/3kW (A3:8) F400	HCF 100 T4/T8 14/3,5kW (A3:8) F400
HCF 100 T4/T8 17/4,3kW (A3:8) F400	HCF 100 T4/T8 20/5kW (A3:8) F400	

AIR FLOW - PRESSURE (4 poles)

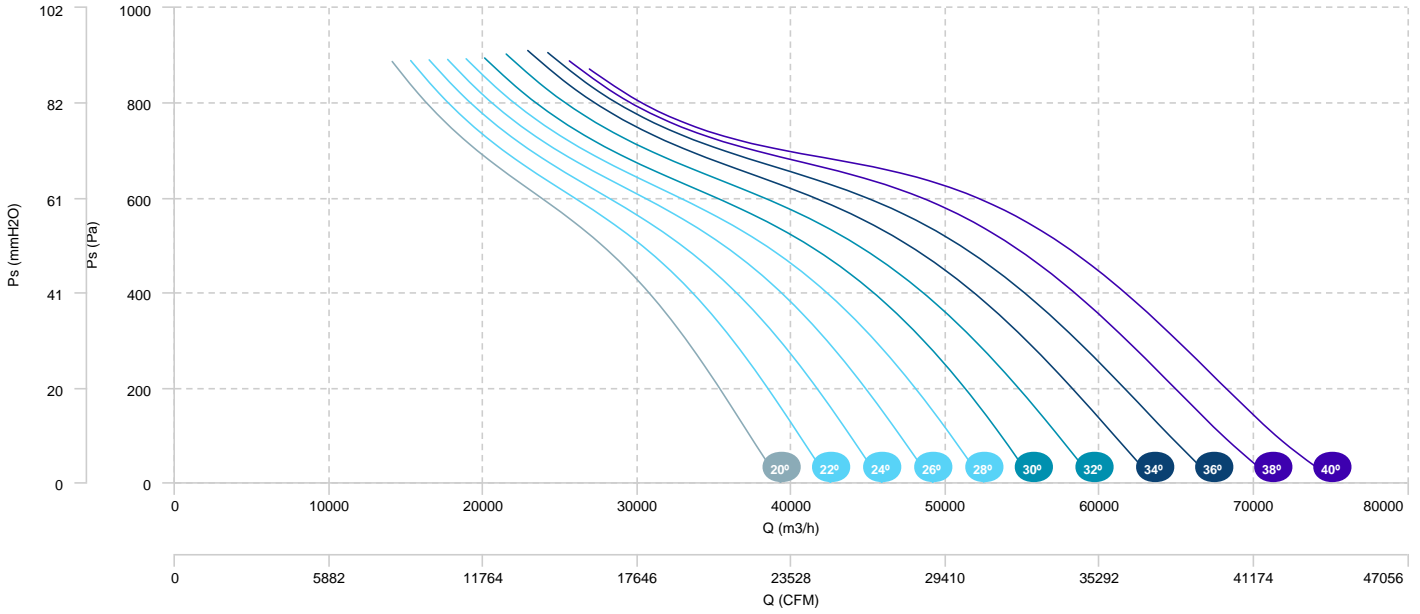

AIR FLOW - ABSORBED POWER (4 poles)

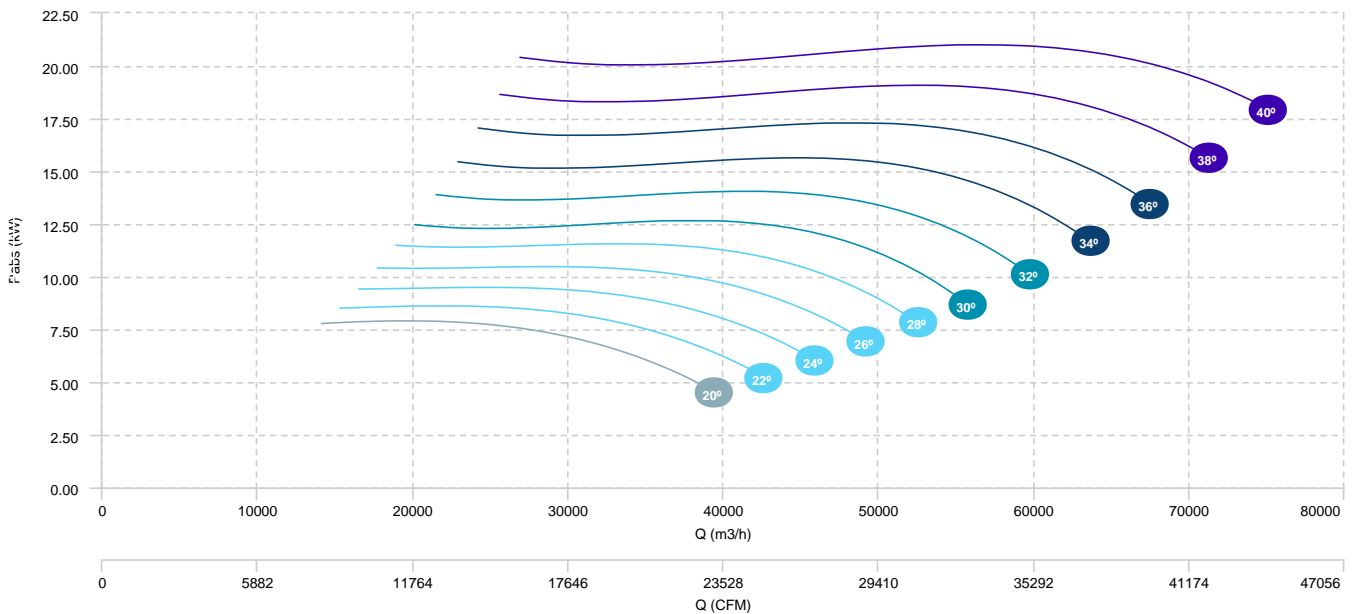

HCF 100 T4/T8 7,5/1,5kW (A3:8) F400	HCF 100 T4/T8 11/3kW (A3:8) F400	HCF 100 T4/T8 14/3,5kW (A3:8) F400
HCF 100 T4/T8 17/4,3kW (A3:8) F400	HCF 100 T4/T8 20/5kW (A3:8) F400	

AIR FLOW - PRESSURE (8 poles)

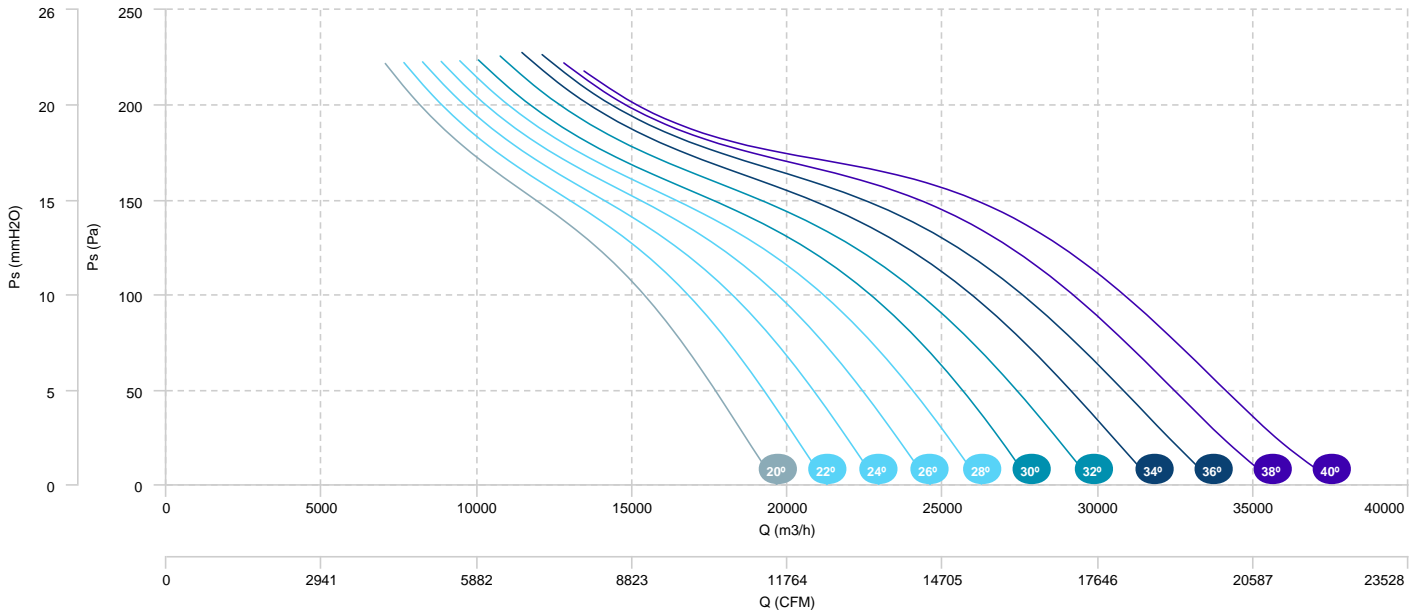

HCF 100 T4/T8 5,5/1,1kW (A3:4) F400	HCF 100 T4/T8 7,5/1,5kW (A3:4) F400	HCF 100 T4/T8 11/3kW (A3:4) F400
HCF 100 T4/T8 14/3,5kW (A3:4) F400		

AIR FLOW - PRESSURE (4 poles)

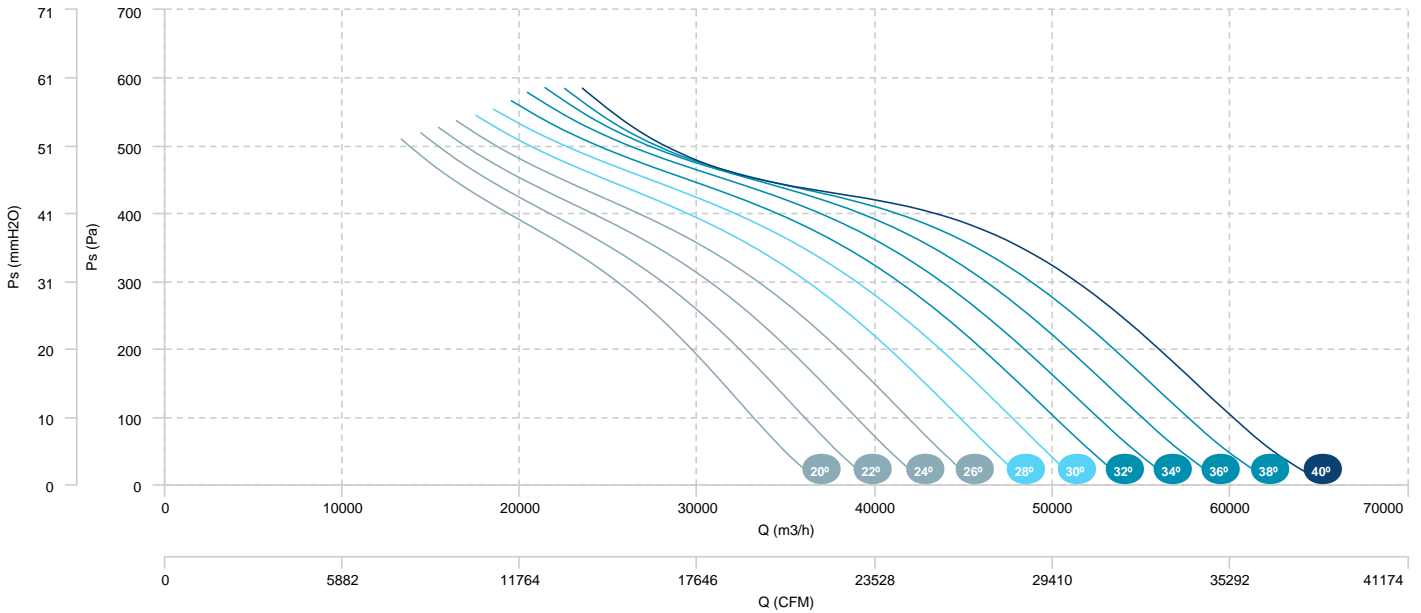

AIR FLOW - ABSORBED POWER (4 poles)

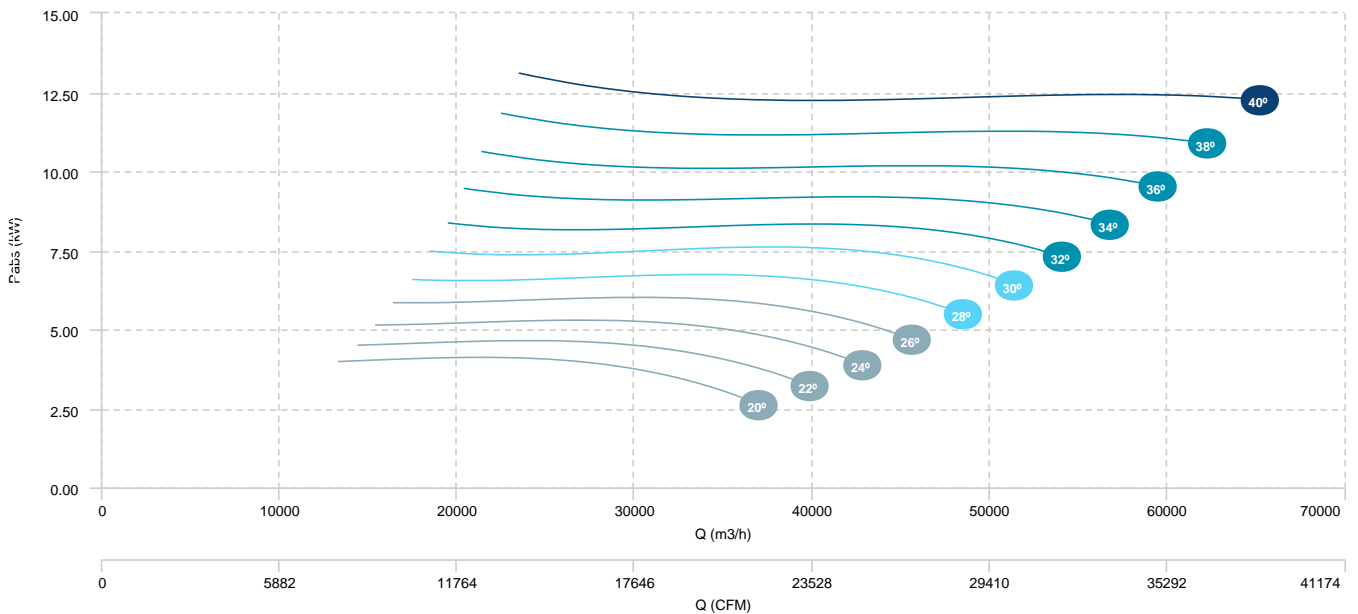

HCF 100 T4/T8 5,5/1,1kW (A3:4) F400	HCF 100 T4/T8 7,5/1,5kW (A3:4) F400	HCF 100 T4/T8 11/3kW (A3:4) F400
HCF 100 T4/T8 14/3,5kW (A3:4) F400		

AIR FLOW - PRESSURE (8 poles)

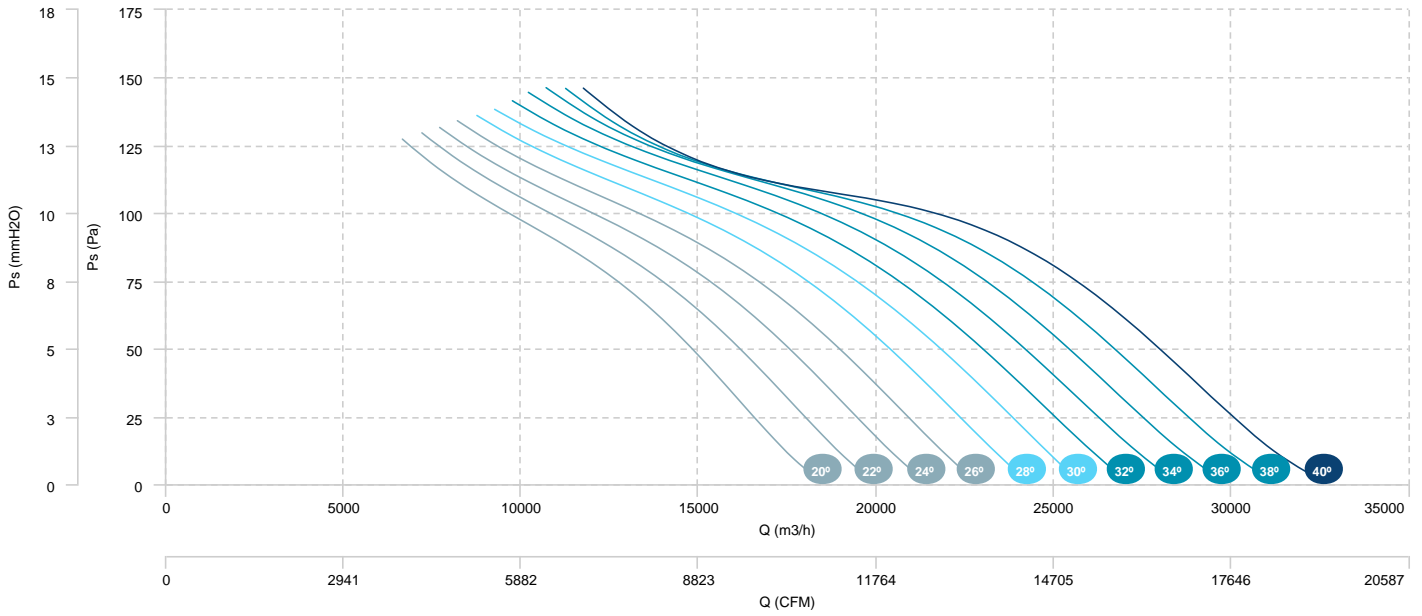

HCF 112 T4 11kW (A3:8) F400	HCF 112 T4 15kW (A3:8) F400	HCF 112 T4 18,5kW (A3:8) F400
HCF 112 T4 22kW (A3:8) F400	HCF 112 T4 30kW (A3:8) F400	

AIR FLOW - PRESSURE

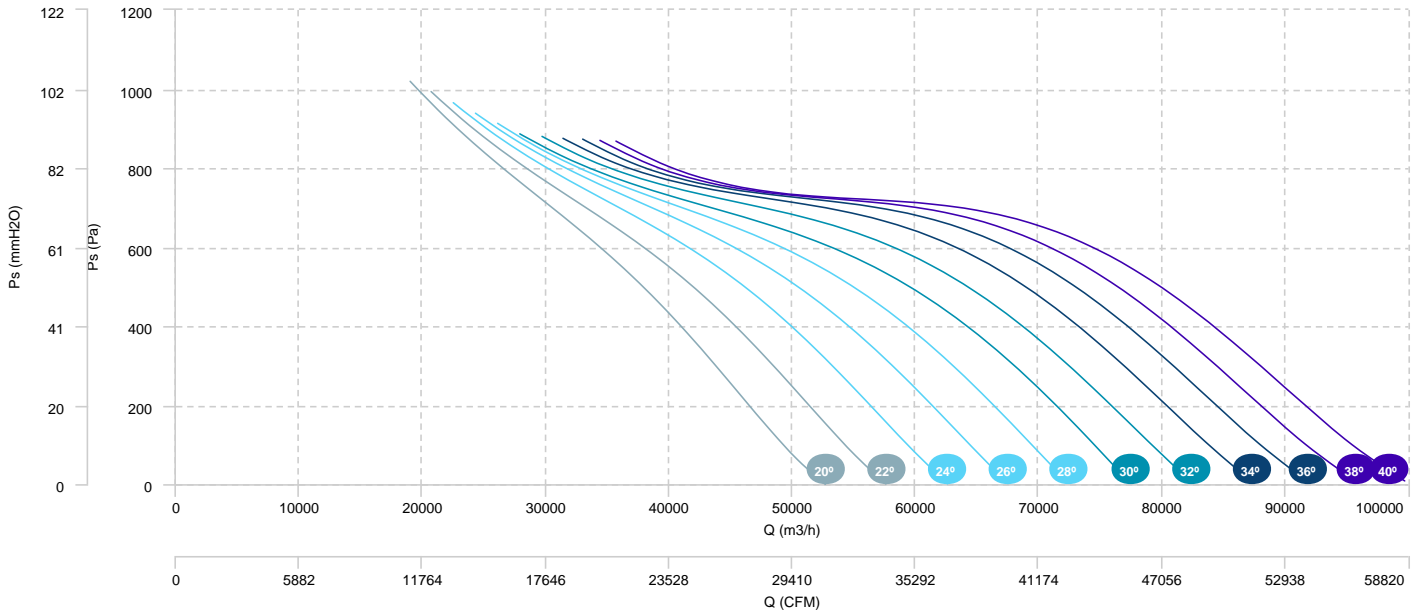

AIR FLOW - ABSORBED POWER

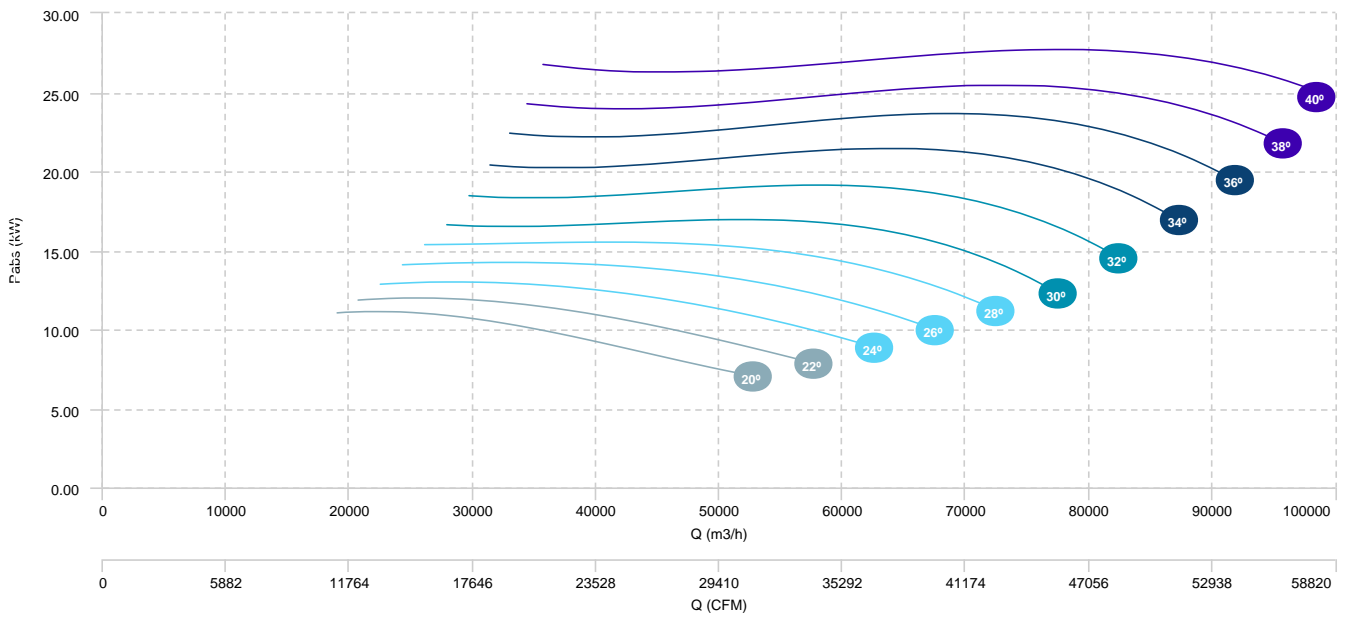

HCF 112 T4 5,5kW (A3:4) F400	HCF 112 T4 7,5kW (A3:4) F400	HCF 112 T4 11kW (A3:4) F400
HCF 112 T4 15kW (A3:4) F400	HCF 112 T4 18,5kW (A3:4) F400	

AIR FLOW - PRESSURE

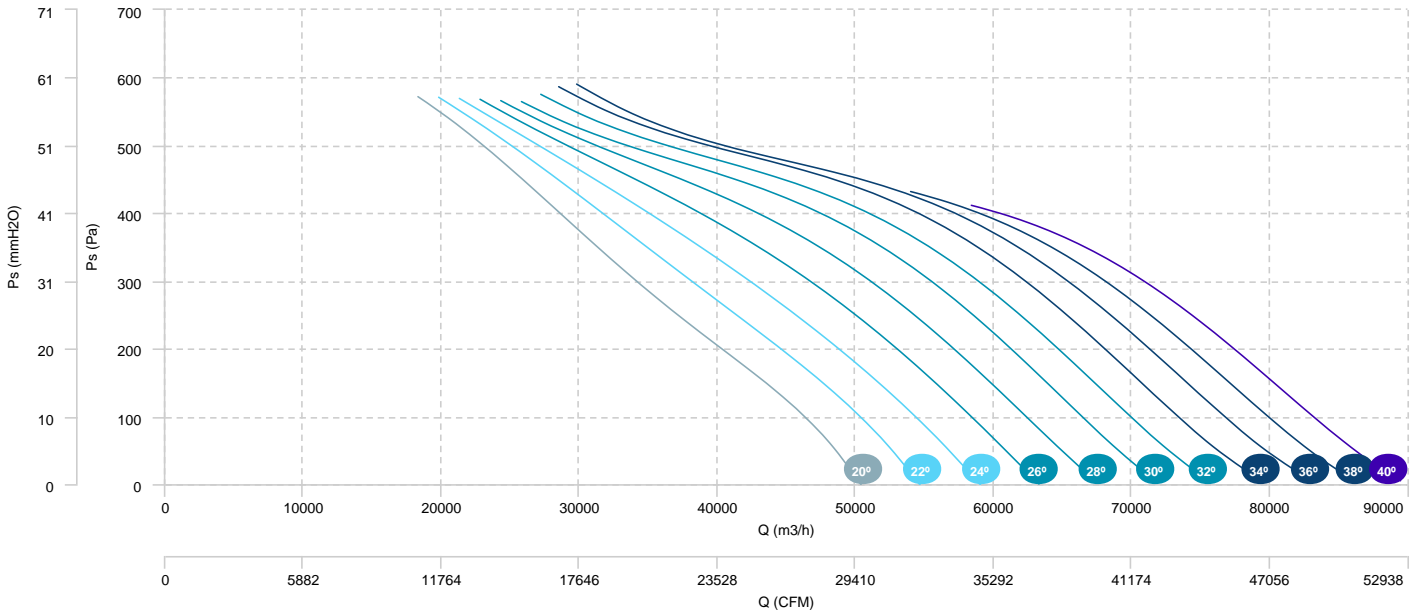

AIR FLOW - ABSORBED POWER

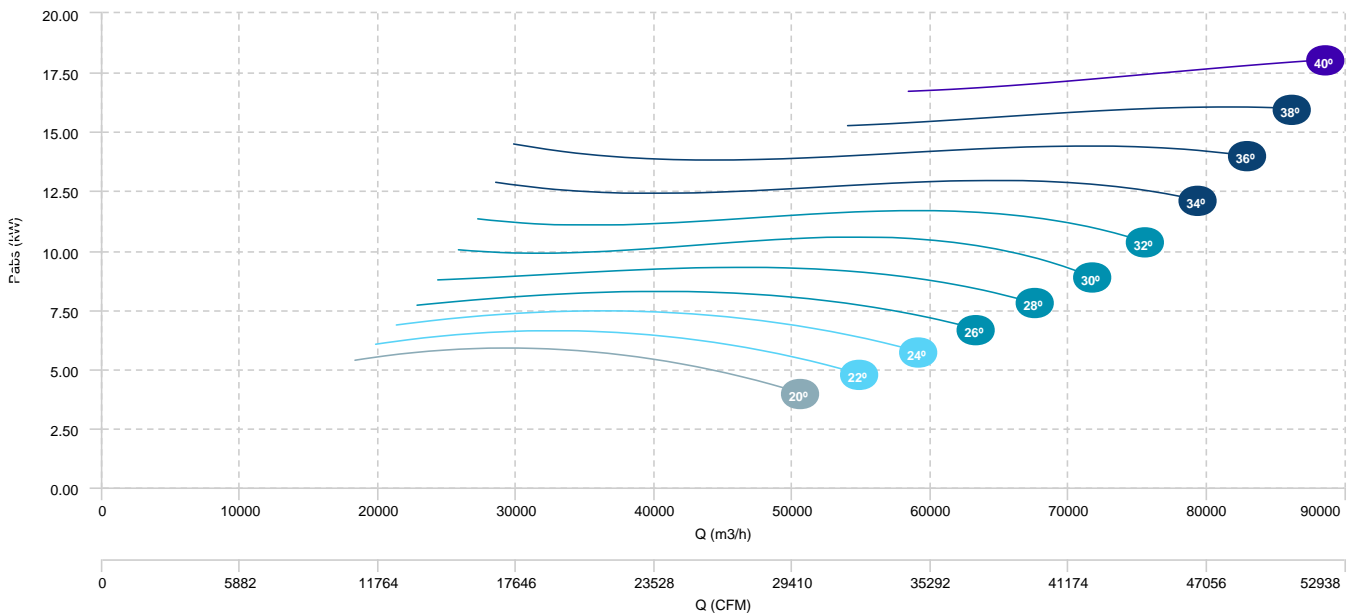

HCF 112 T6 3kW (A3:8) F400	HCF 112 T6 4kW (A3:8) F400	HCF 112 T6 5,5kW (A3:8) F400
HCF 112 T6 7,5kW (A3:8) F400		

AIR FLOW - PRESSURE

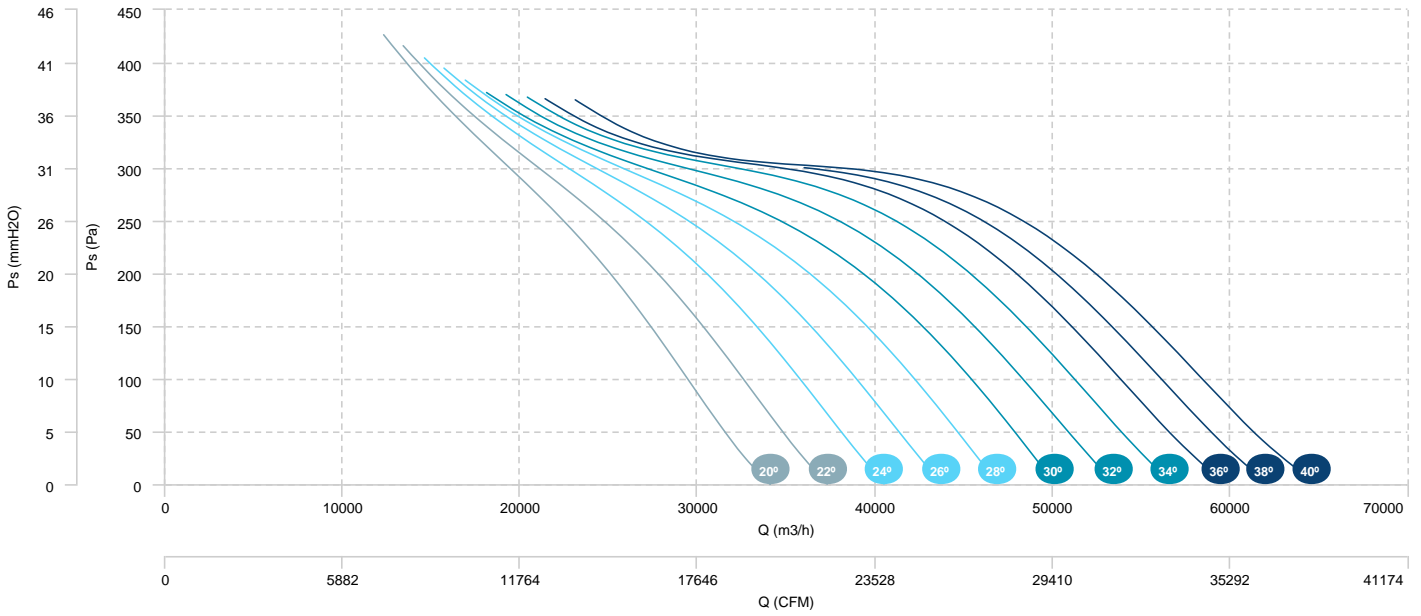

AIR FLOW - ABSORBED POWER

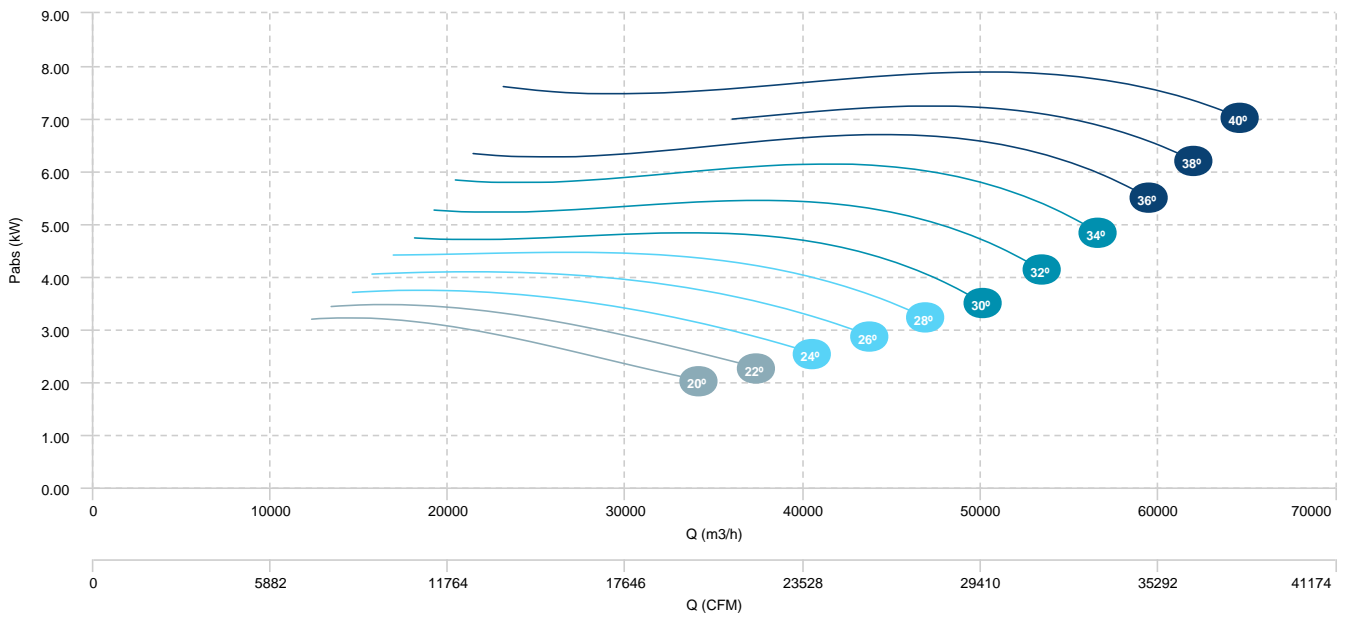

HCF 112 T6 2,2kW (A3:4) F400	HCF 112 T6 3kW (A3:4) F400	HCF 112 T6 4kW (A3:4) F400
HCF 112 T6 5,5kW (A3:4) F400		

AIR FLOW - PRESSURE

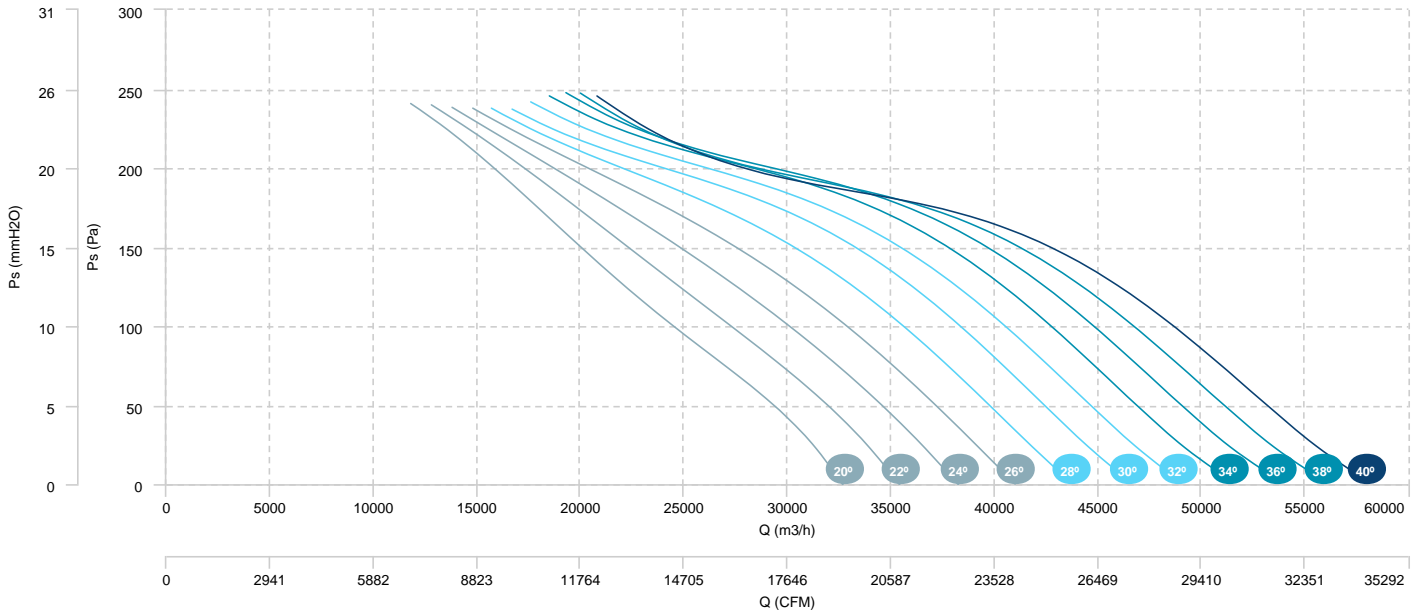

AIR FLOW - ABSORBED POWER

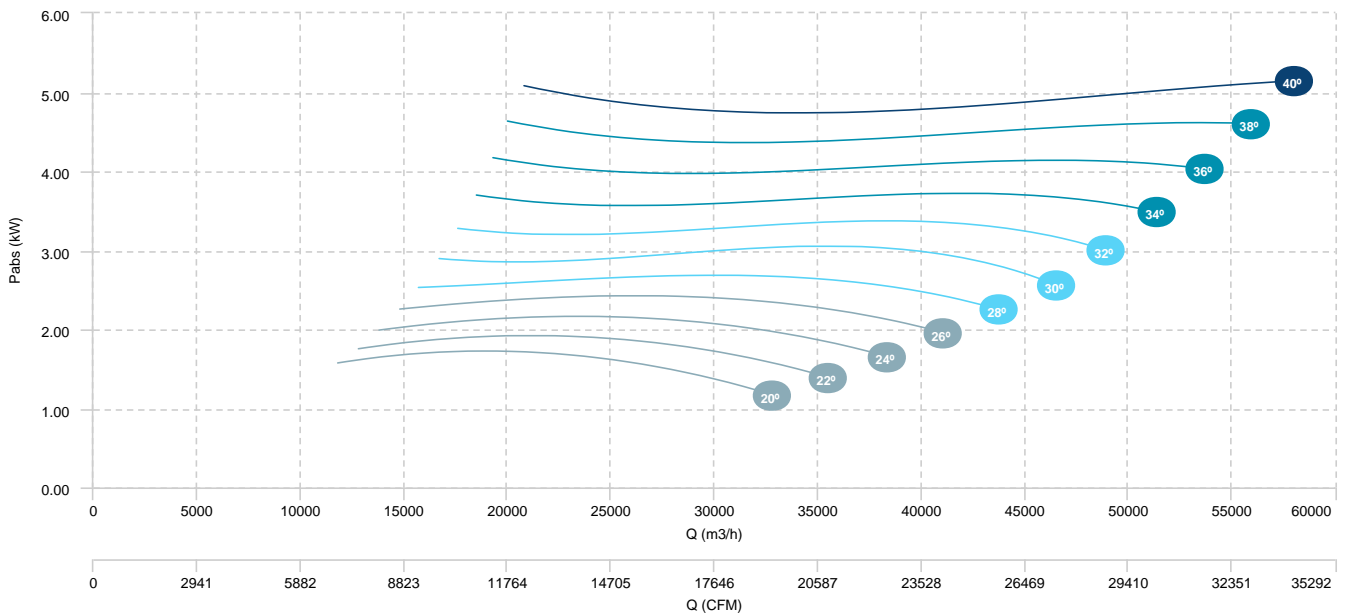

HCF 112 T4/T8 11/3kW (A3:8) F400	HCF 112 T4/T8 14/3,5kW (A3:8) F400	HCF 112 T4/T8 17/4,3kW (A3:8) F400
HCF 112 T4/T8 20/5kW (A3:8) F400	HCF 112 T4/T8 28/6,5kW (A3:8) F400	

AIR FLOW - PRESSURE (4 poles)

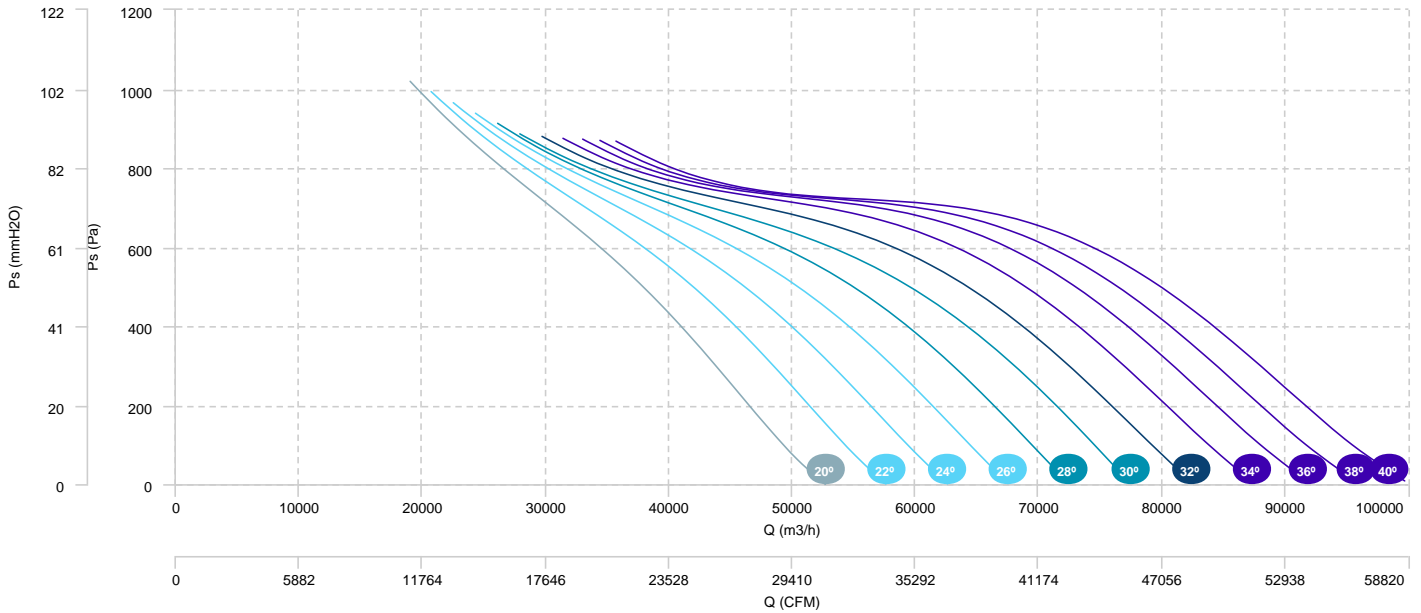

AIR FLOW - ABSORBED POWER (4 poles)

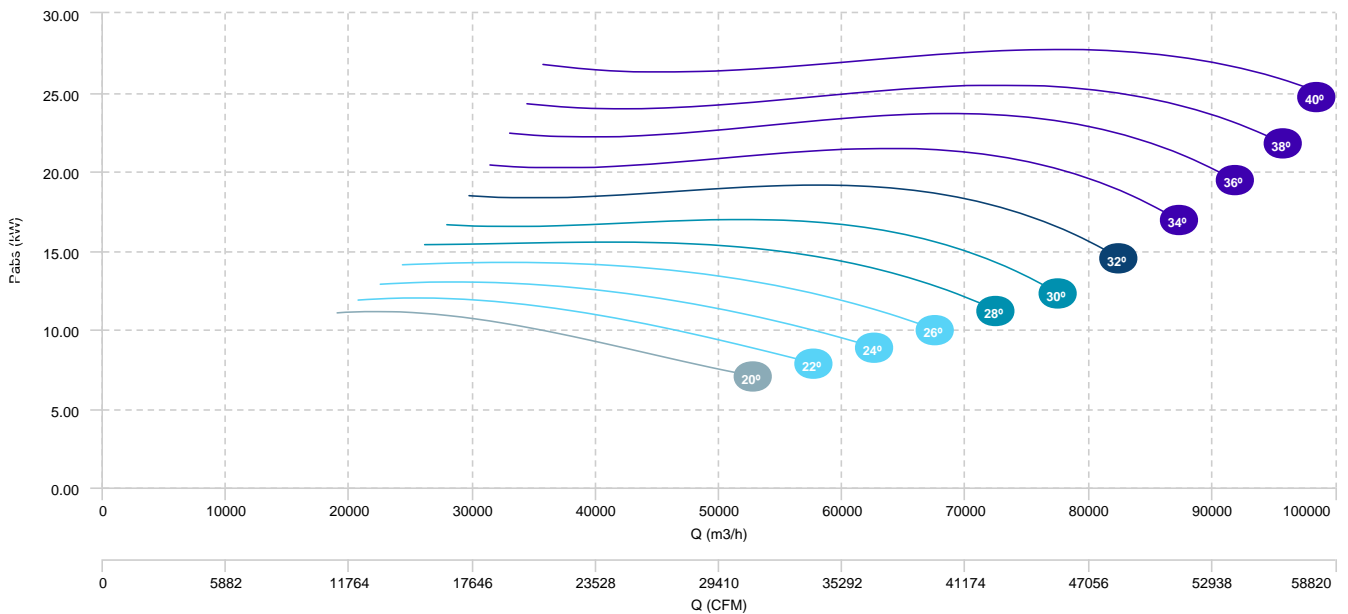

HCF 112 T4/T8 11/3kW (A3:8) F400	HCF 112 T4/T8 14/3,5kW (A3:8) F400	HCF 112 T4/T8 17/4,3kW (A3:8) F400
HCF 112 T4/T8 20/5kW (A3:8) F400	HCF 112 T4/T8 28/6,5kW (A3:8) F400	

AIR FLOW - PRESSURE (8 poles)

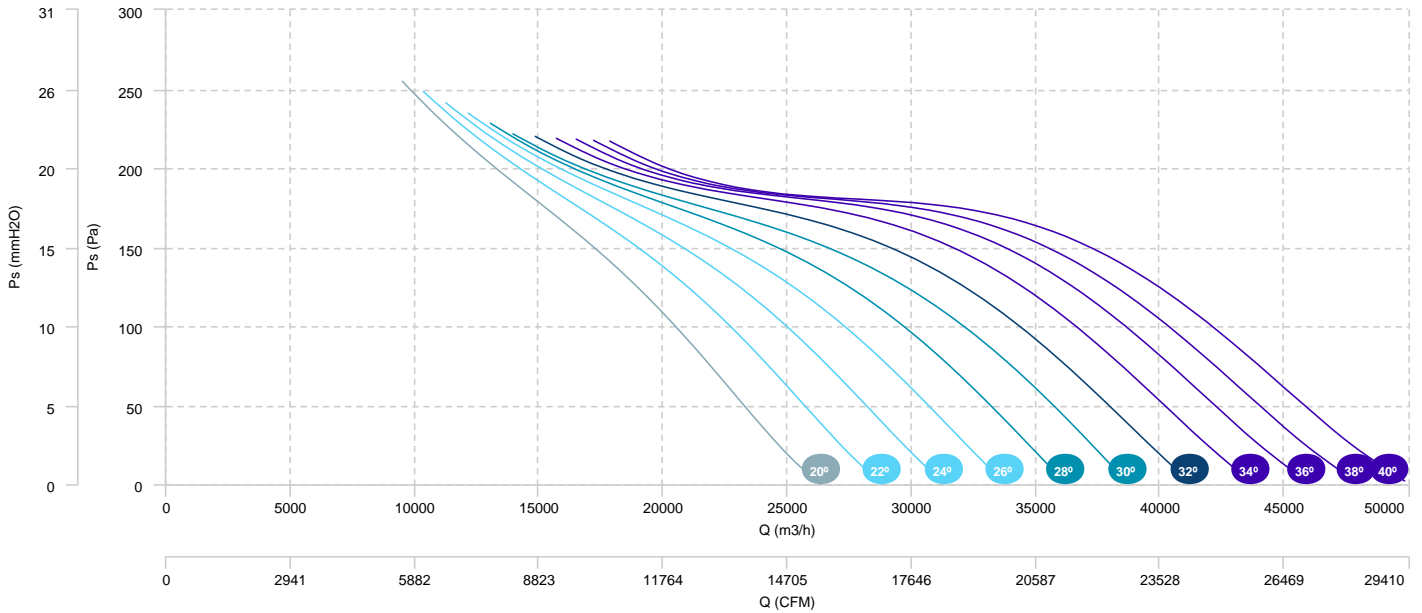

HCF 112 T4/T8 5,5/1,1kW (A3:4) F400	HCF 112 T4/T8 7,5/1,5kW (A3:4) F400	HCF 112 T4/T8 11/3kW (A3:4) F400
HCF 112 T4/T8 14/3,5kW (A3:4) F400	HCF 112 T4/T8 17/4,3kW (A3:4) F400	

AIR FLOW - PRESSURE (4 poles)

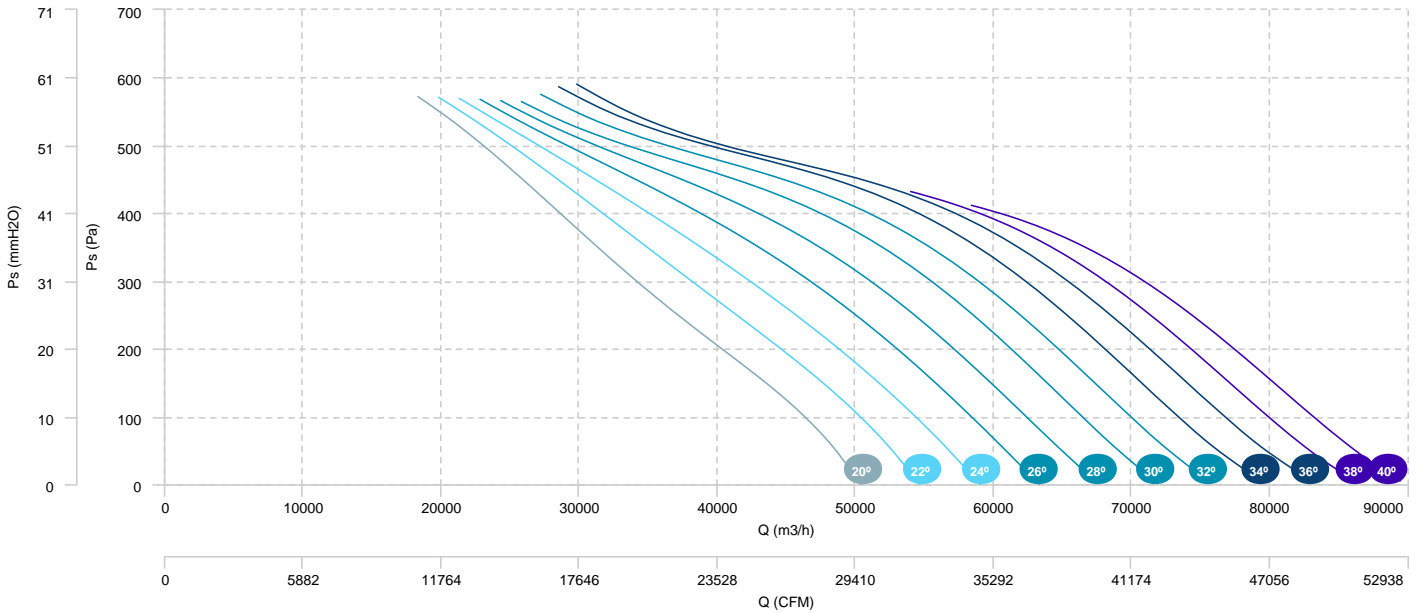

AIR FLOW - ABSORBED POWER (4 poles)

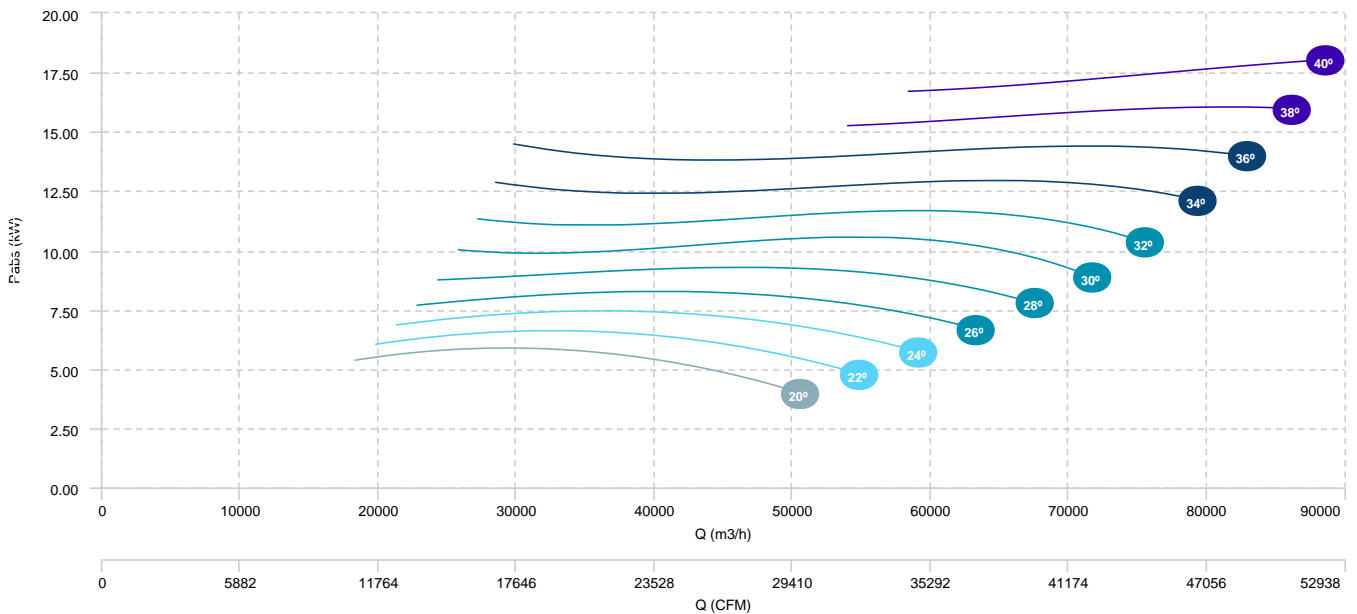

HCF 112 T4/T8 5,5/1,1kW (A3:4) F400	HCF 112 T4/T8 7,5/1,5kW (A3:4) F400	HCF 112 T4/T8 11/3kW (A3:4) F400
HCF 112 T4/T8 14/3,5kW (A3:4) F400	HCF 112 T4/T8 17/4,3kW (A3:4) F400	

AIR FLOW - PRESSURE (8 poles)

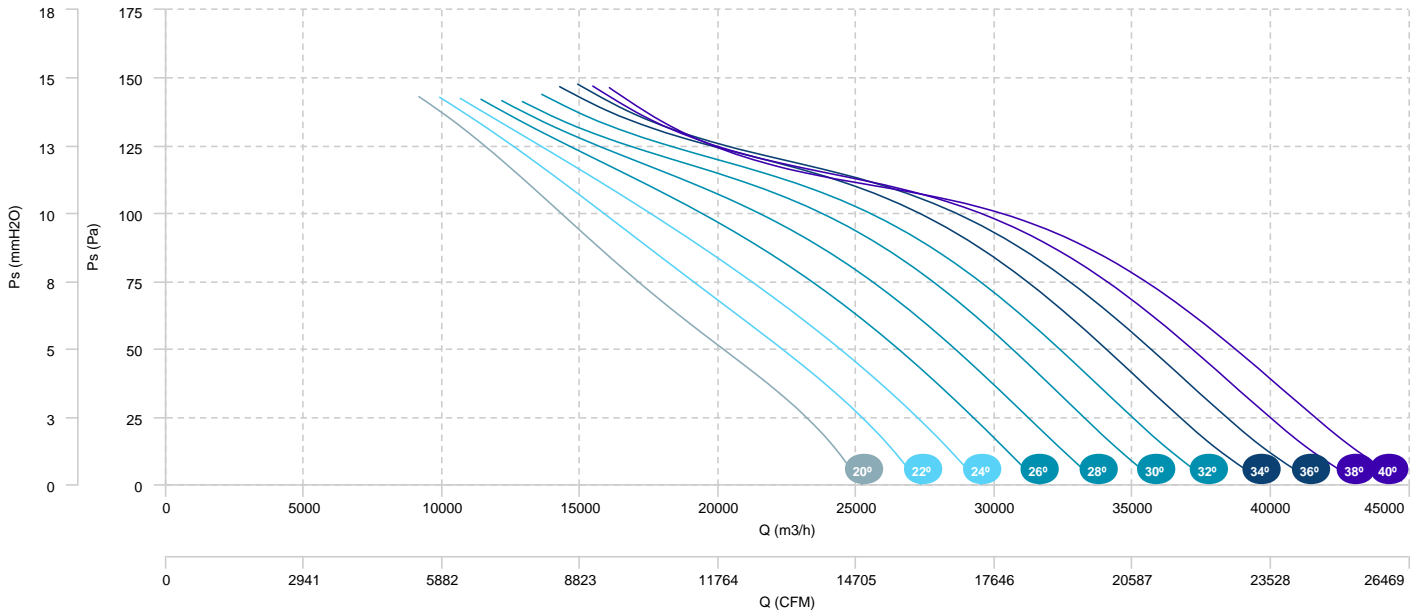

HCF 125 T4 18,5kW (A3:8) F400	HCF 125 T4 22kW (A3:8) F400	HCF 125 T4 30kW (A3:8) F400
HCF 125 T4 37kW (A3:8) F400	HCF 125 T4 45kW (A3:8) F400	

AIR FLOW - PRESSURE

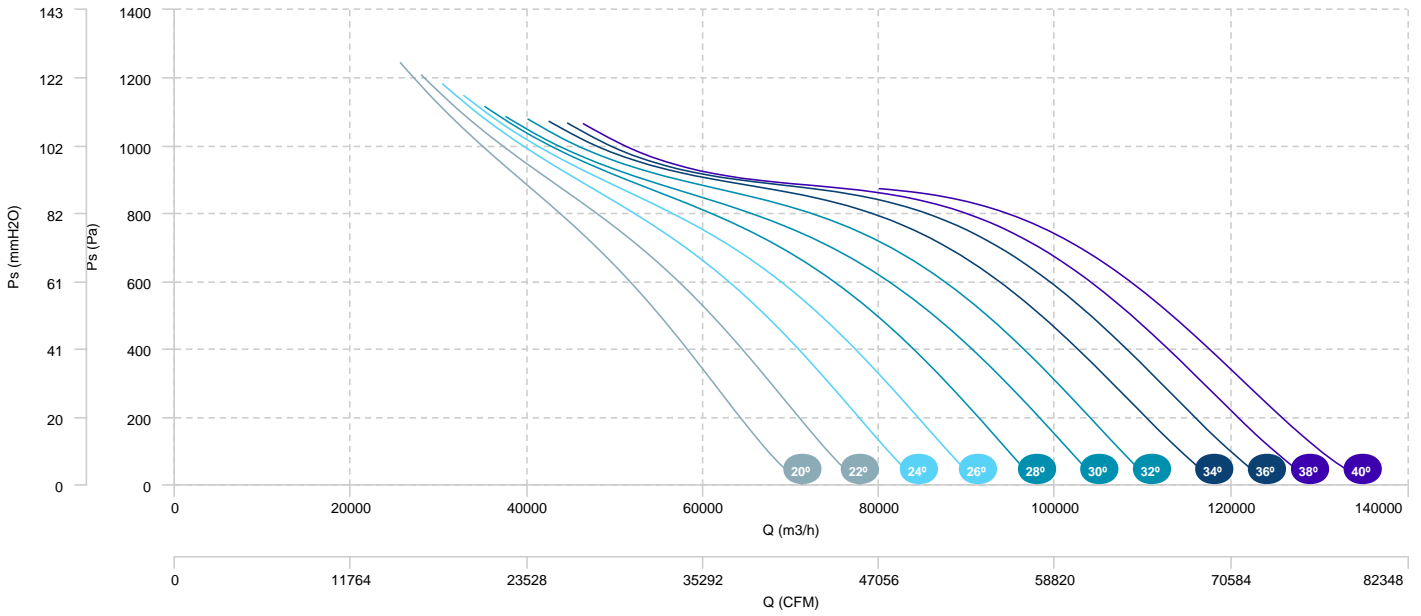

AIR FLOW - ABSORBED POWER

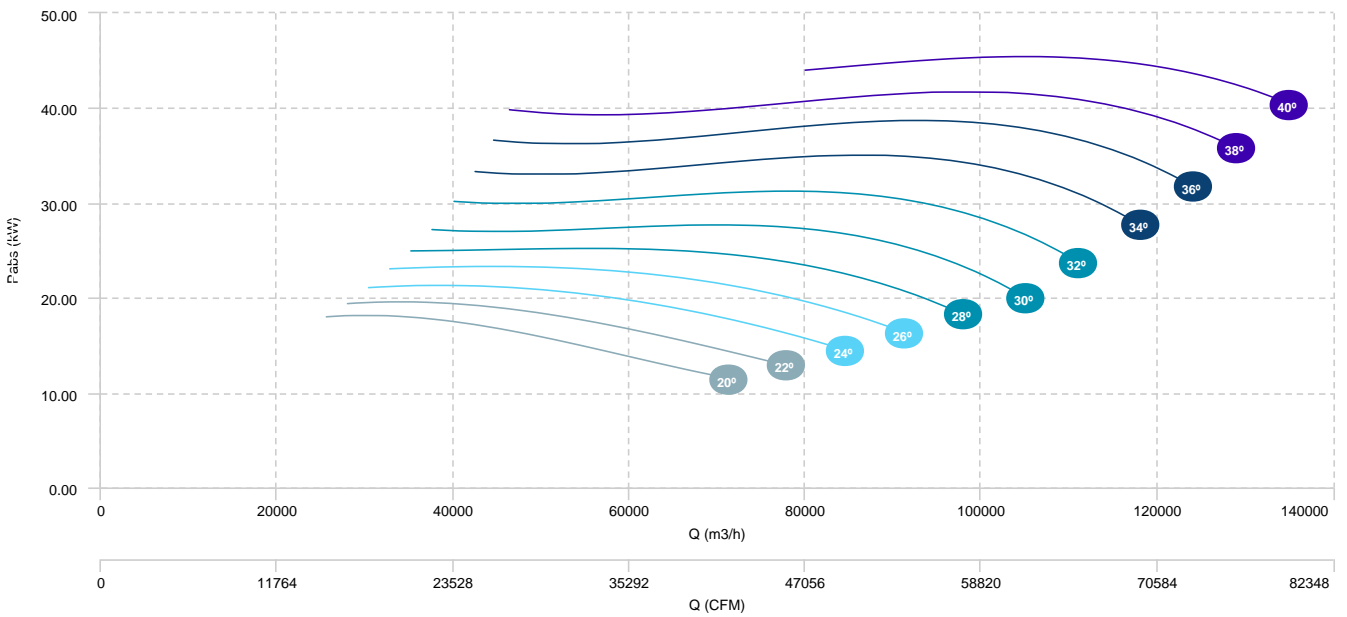

HCF 125 T4 11kW (A3:4) F400	HCF 125 T4 15kW (A3:4) F400	HCF 125 T4 18,5kW (A3:4) F400
HCF 125 T4 22kW (A3:4) F400	HCF 125 T4 30kW (A3:4) F400	

AIR FLOW - PRESSURE

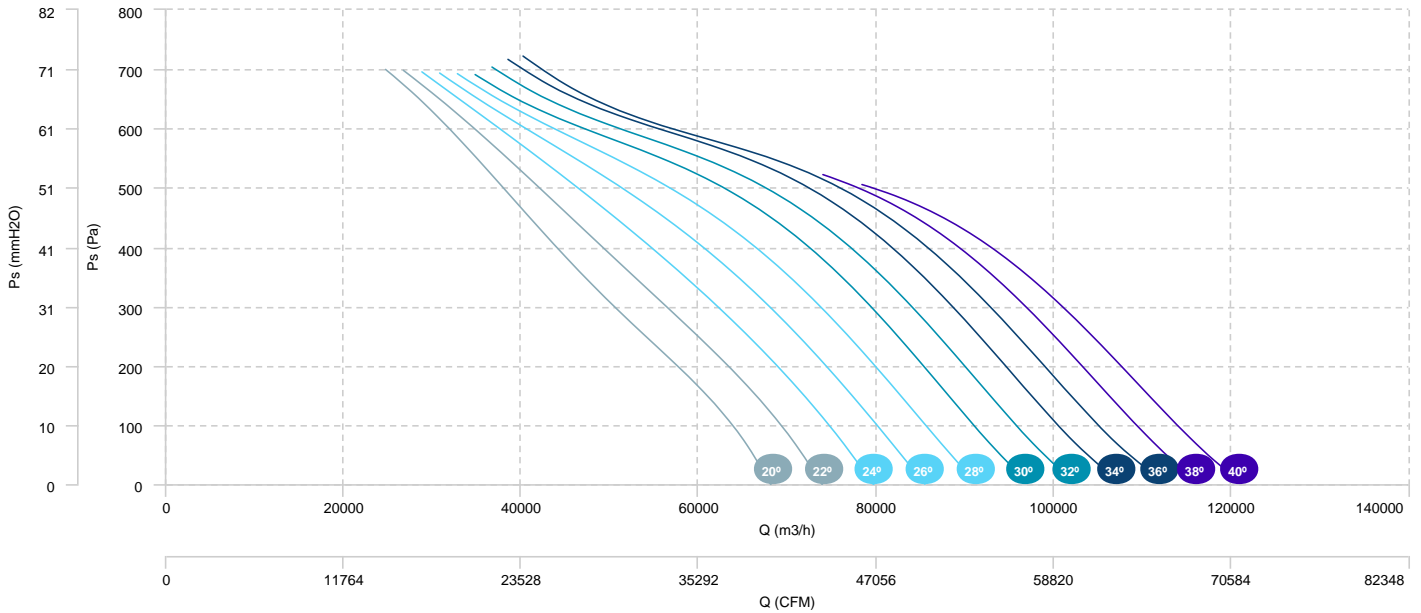

AIR FLOW - ABSORBED POWER

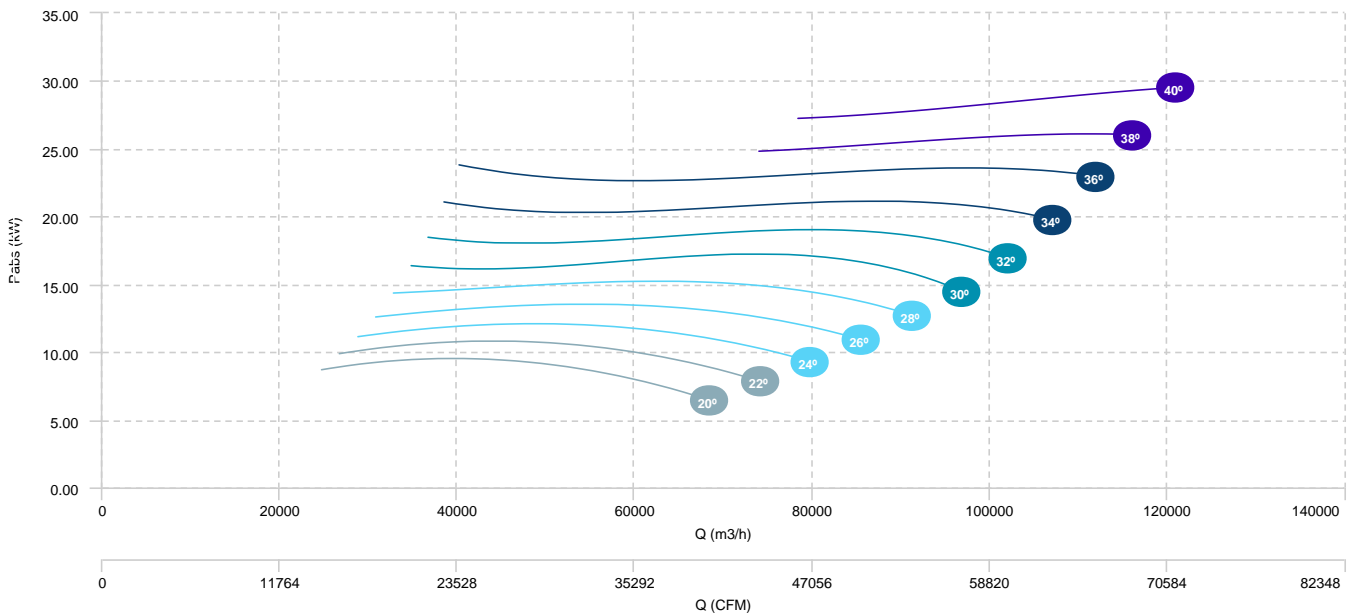

HCF 125 T6 3kW (A3:4) F400
 HCF 125 T6 7,5kW (A3:4) F400

HCF 125 T6 4kW (A3:4) F400

HCF 125 T6 5,5kW (A3:4) F400

AIR FLOW - PRESSURE

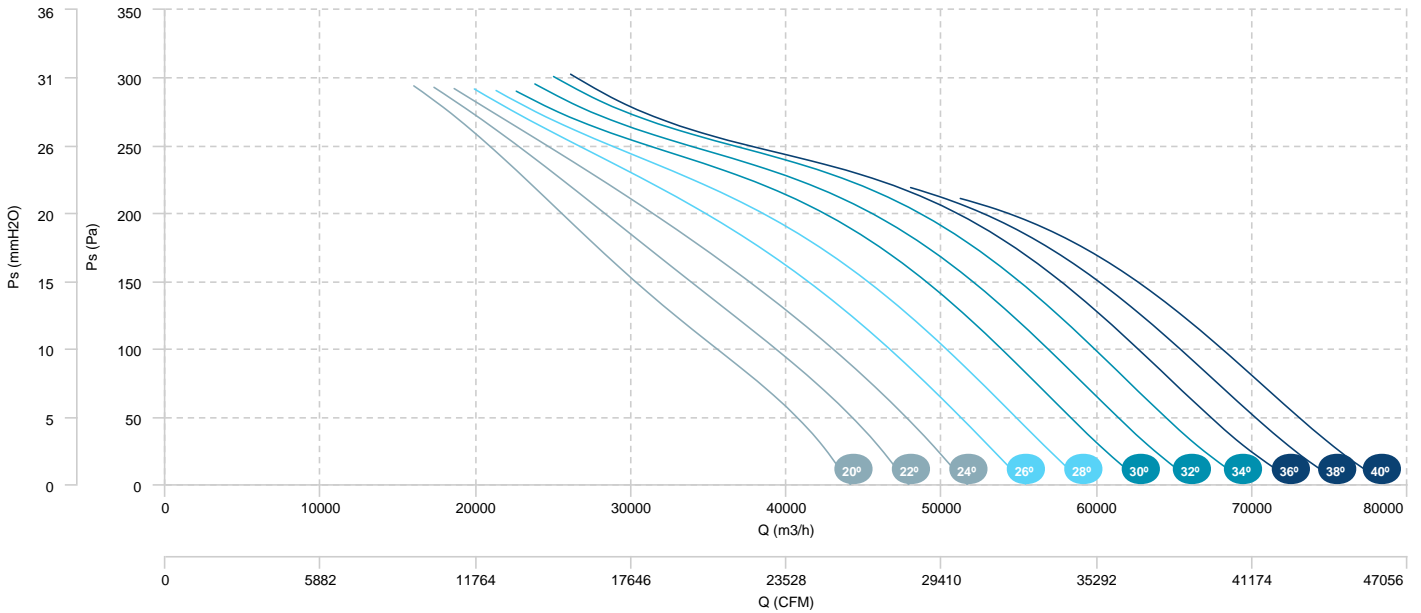

AIR FLOW - ABSORBED POWER

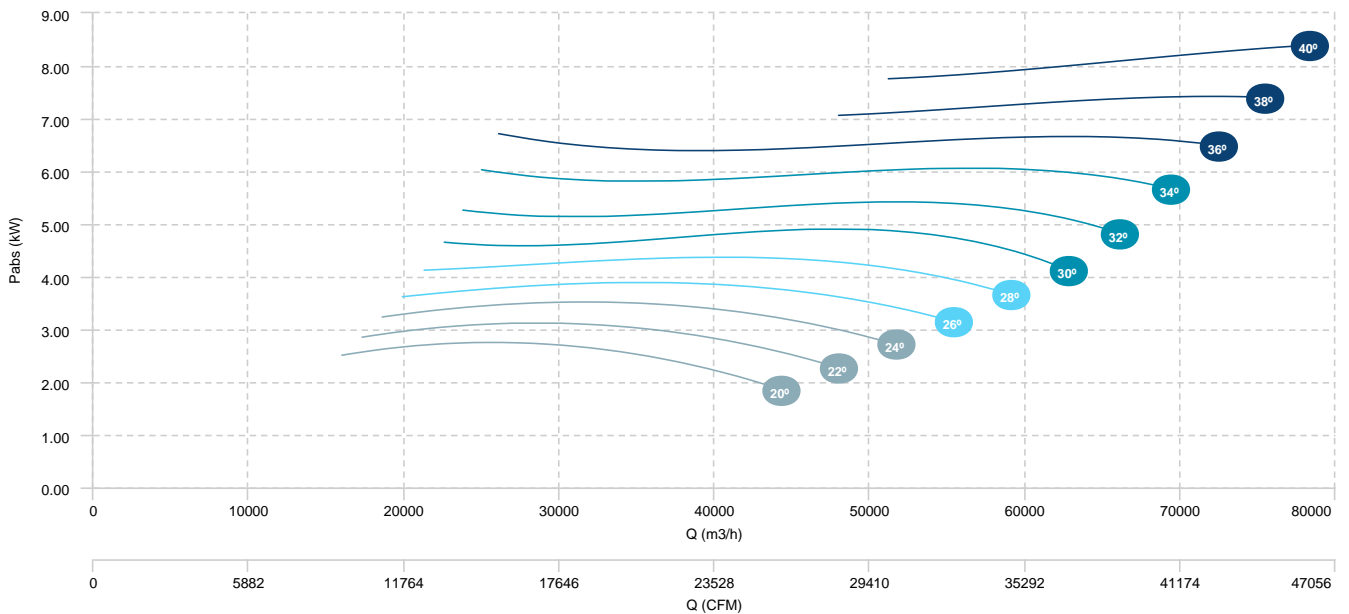

HCF 125 T6 5,5kW (A3:8) F400	HCF 125 T6 7,5kW (A3:8) F400	HCF 125 T6 11kW (A3:8) F400
HCF 125 T6 15kW (A3:8) F400		

AIR FLOW - PRESSURE

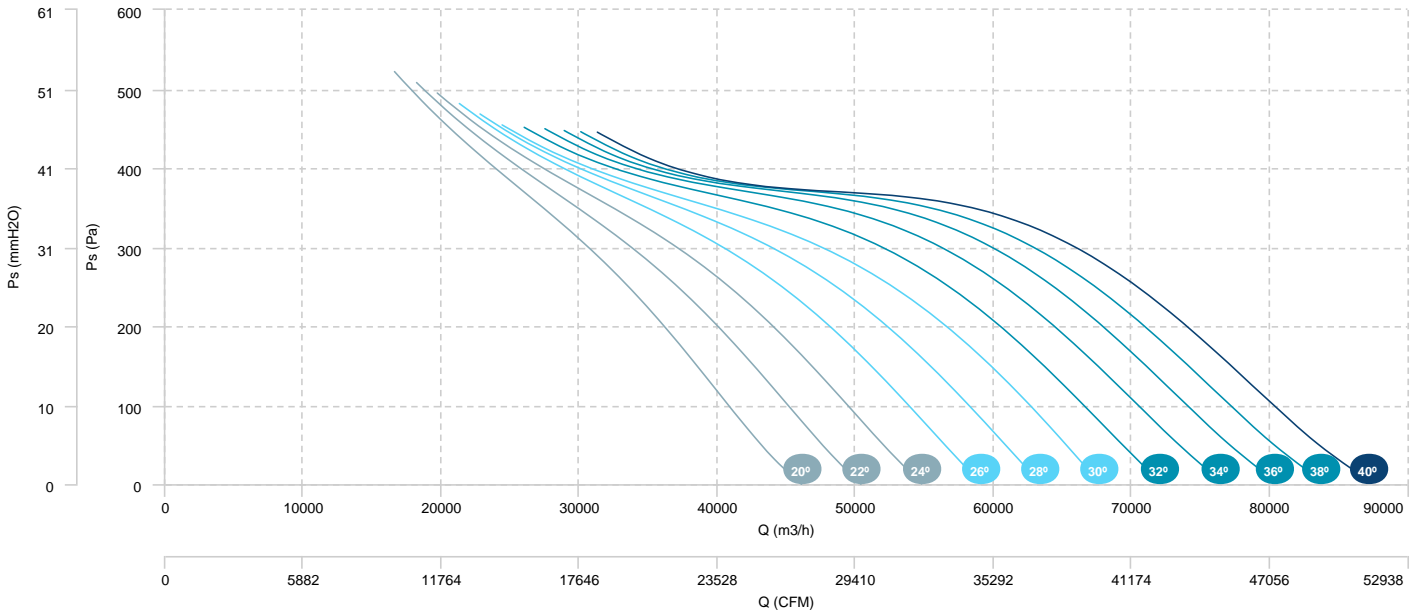

AIR FLOW - ABSORBED POWER

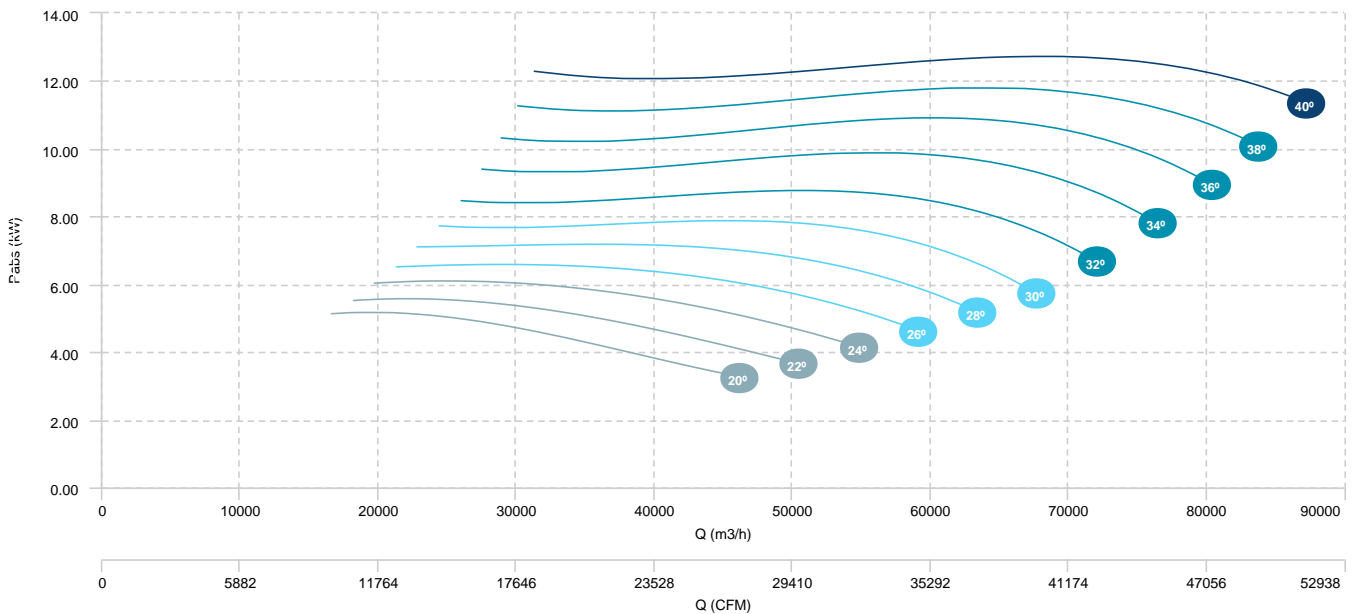

HCF 125 T4/T8 20/5kW (A3:8) F400	HCF 125 T4/T8 28/6,5kW (A3:8) F400	HCF 125 T4/T8 37/9,2kW (A3:8) F400
HCF 125 T4/T8 44/11kW (A3:8) F400		

AIR FLOW - PRESSURE (4 poles)

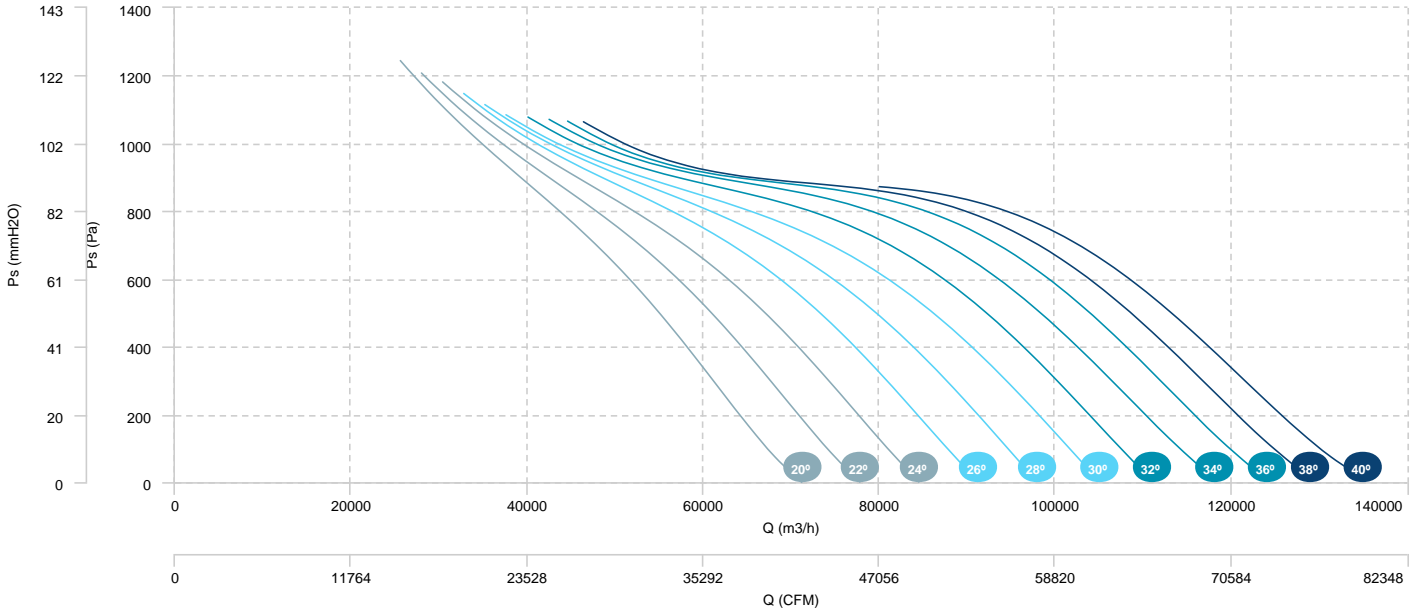

AIR FLOW - ABSORBED POWER (4 poles)

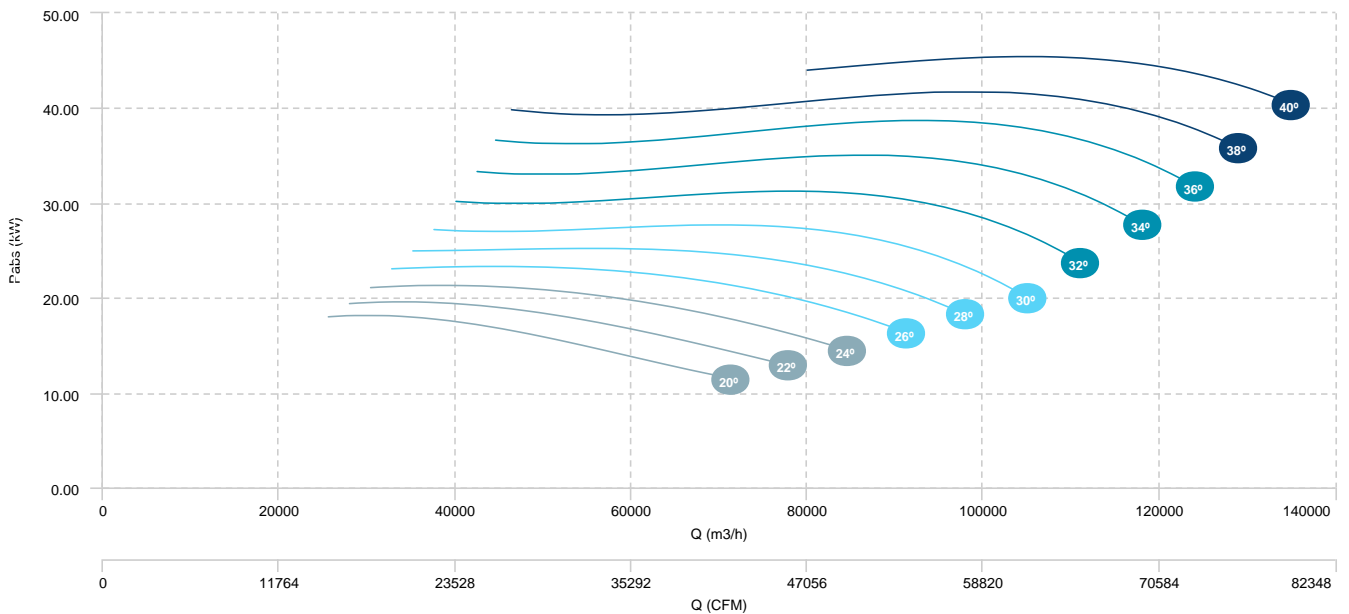

HCF 125 T4/T8 20/5kW (A3:8) F400	HCF 125 T4/T8 28/6,5kW (A3:8) F400	HCF 125 T4/T8 37/9,2kW (A3:8) F400
HCF 125 T4/T8 44/11kW (A3:8) F400		

AIR FLOW - PRESSURE (8 poles)

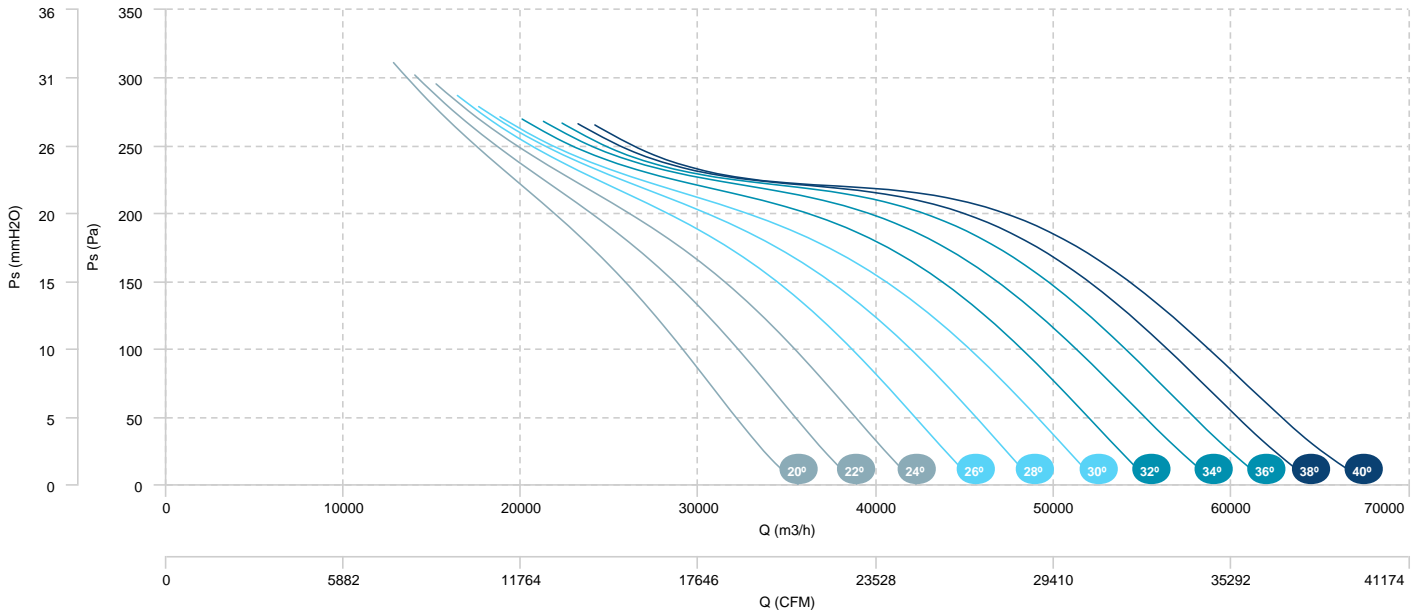

HCF 125 T4/T8 11/3kW (A3:4) F400	HCF 125 T4/T8 14/3,5kW (A3:4) F400	HCF 125 T4/T8 17/4,3kW (A3:4) F400
HCF 125 T4/T8 20/5kW (A3:4) F400	HCF 125 T4/T8 28/6,5kW (A3:4) F400	

AIR FLOW - PRESSURE (4 poles)

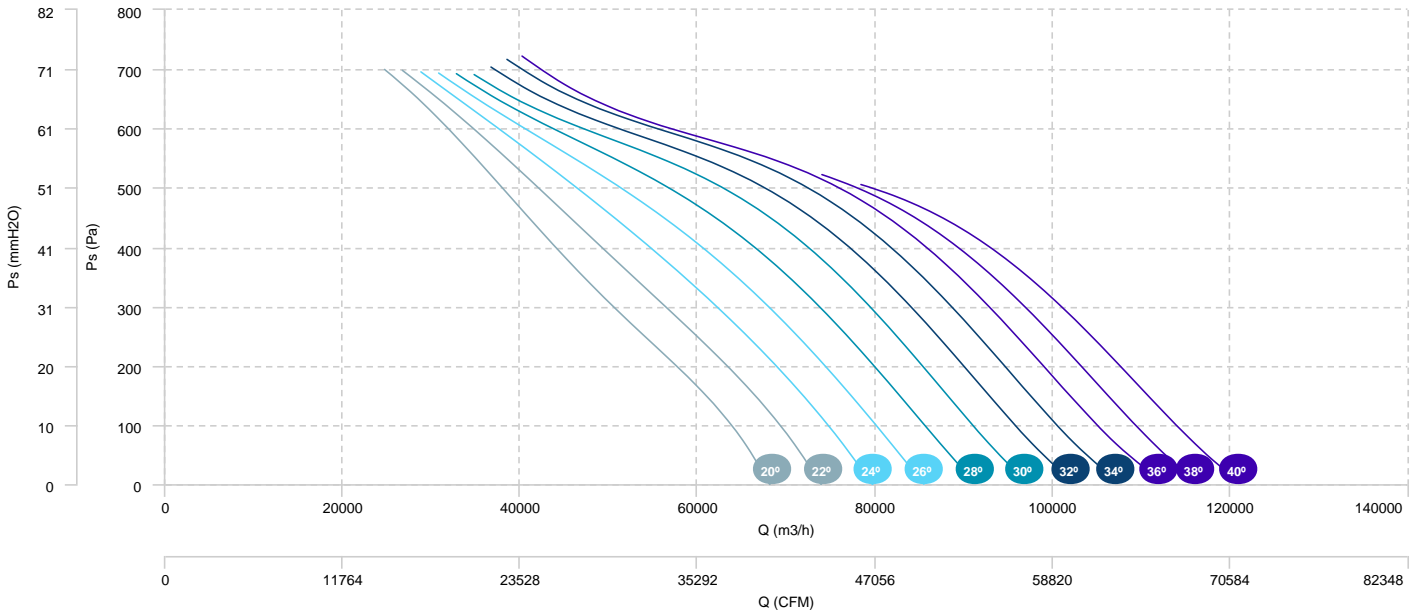

AIR FLOW - ABSORBED POWER (4 poles)

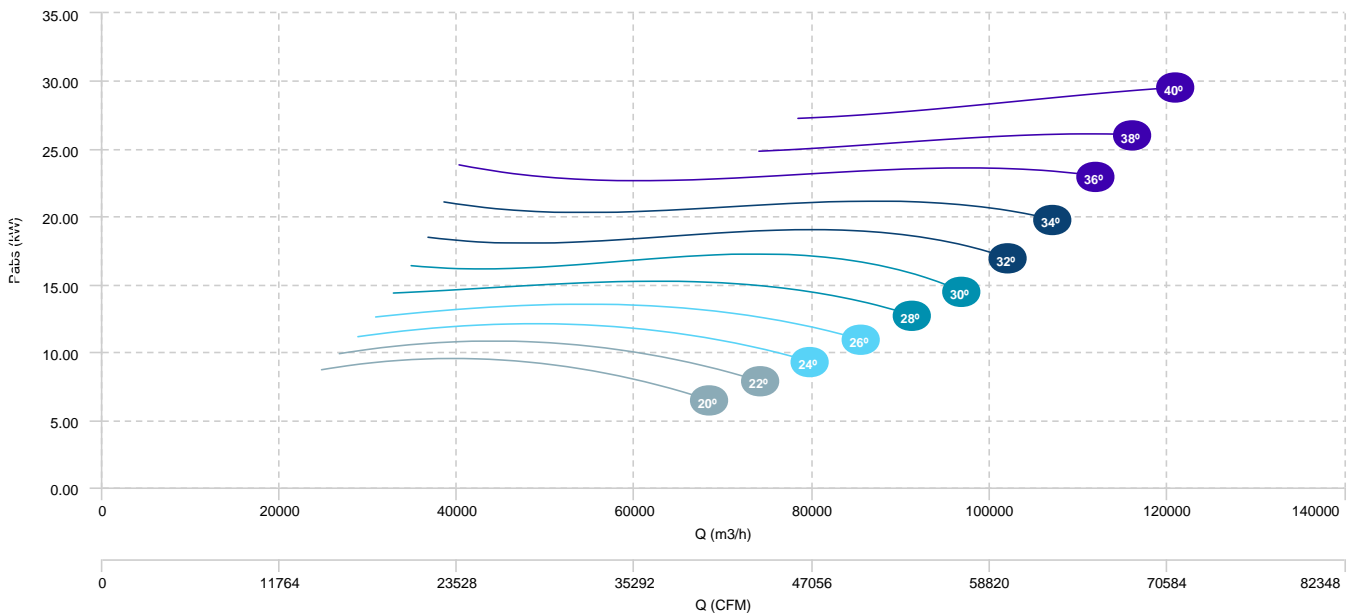

HCF 125 T4/T8 11/3kW (A3:4) F400	HCF 125 T4/T8 14/3,5kW (A3:4) F400	HCF 125 T4/T8 17/4,3kW (A3:4) F400
HCF 125 T4/T8 20/5kW (A3:4) F400	HCF 125 T4/T8 28/6,5kW (A3:4) F400	

AIR FLOW - PRESSURE (8 poles)

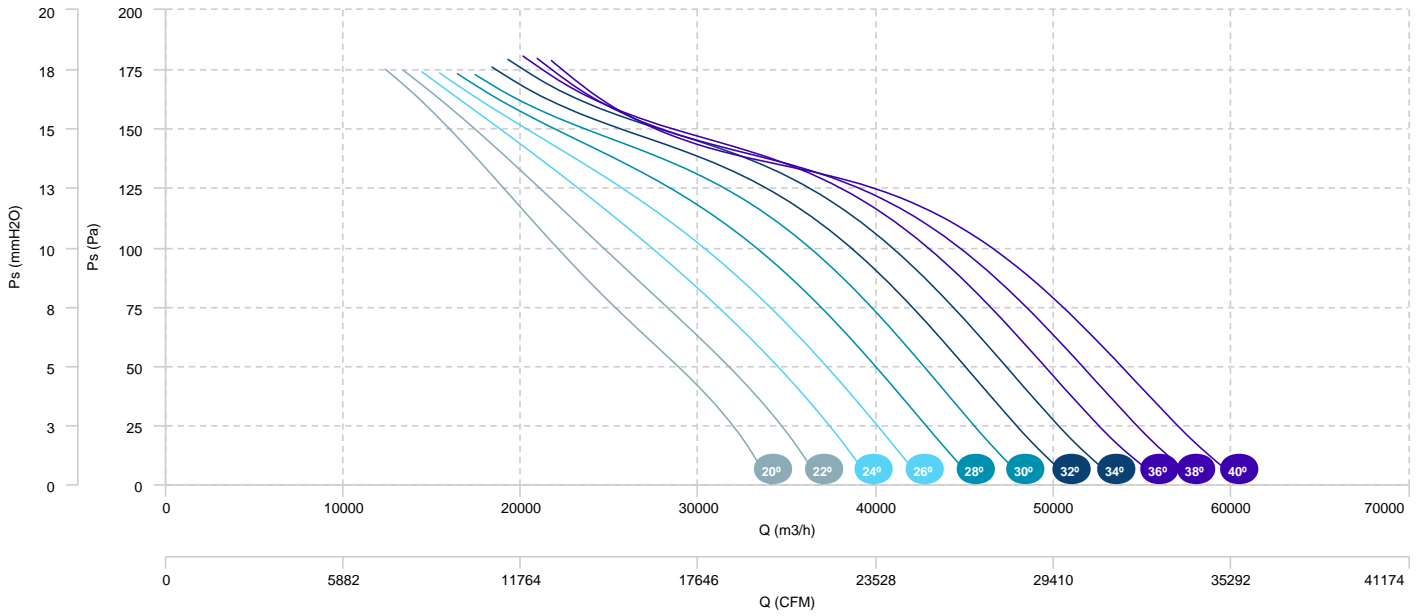

Sound data

Sound / 4 poles

		Sound power Lw dB (A)								
Model		63 Hz	125 Hz	250 Hz	500 Hz	1000 Hz	2000 Hz	4000 Hz	8000 Hz	Total
HCF 45 T4 0,75kW (A5:6) F400 (40°)	Inlet	50	57	62	67	70	70	71	64	76
HCF 50 T4 0,75kW (A5:6) F400 (40°)	Inlet	53	60	65	69	72	71	72	66	78
HCF 56 T4 0,75kW (A5:6) F400 (25°)	Inlet	54	62	67	75	79	76	78	70	84
HCF 56 T4 0,75kW (A5:6) F400 (32.5°)	Inlet	54	61	66	75	75	76	79	70	83
HCF 56 T4 0,75kW (A5:6) F400 (30°)	Inlet	56	63	68	77	78	78	80	72	85
HCF 56 T4 1,1kW (A5:6) F400 (37.5°)	Inlet	54	61	66	75	74	76	78	69	82
HCF 56 T4 1,1kW (A5:6) F400 (35°)	Inlet	53	60	65	74	73	75	78	69	82
HCF 56 T4 1,5kW (A5:6) F400 (40°)	Inlet	56	63	68	76	75	76	79	70	83
HCF 56 T4 1,5kW (A5:6) F400 (42.5°)	Inlet	58	65	70	76	76	77	79	70	84
HCF 63 T4 0,75kW (A5:6) F400 (25°)	Inlet	57	66	71	80	80	79	80	75	86
HCF 63 T4 1,1kW (A5:6) F400 (30°)	Inlet	60	68	74	80	80	79	82	77	87
HCF 63 T4 1,5kW (A5:6) F400 (35°)	Inlet	59	67	72	75	76	76	79	73	83
HCF 63 T4 1,5kW (A5:6) F400 (32.5°)	Inlet	59	68	73	77	78	77	80	75	85
HCF 63 T4 2,2kW (A5:6) F400 (40°)	Inlet	60	67	72	77	78	78	80	73	85
HCF 63 T4 2,2kW (A5:6) F400 (37.5°)	Inlet	59	67	72	76	77	77	79	73	84
HCF 71 T4 0,75kW (A5:6) F400 (20°)	Inlet	55	66	71	86	85	82	84	76	91
HCF 71 T4 1,1kW (A5:6) F400 (25°)	Inlet	59	67	72	84	84	82	84	75	90
HCF 71 T4 1,5kW (A5:6) F400 (30°)	Inlet	61	68	73	82	82	83	84	73	89
HCF 71 T4 2,2kW (A5:6) F400 (35°)	Inlet	62	69	74	76	80	82	83	72	87
HCF 71 T4 2,2kW (A5:6) F400 (32.5°)	Inlet	62	69	74	79	81	83	84	73	88
HCF 71 T4 3kW (A5:6) F400 (40°)	Inlet	67	73	79	81	84	85	86	76	91
HCF 71 T4 3kW (A5:6) F400 (37.5°)	Inlet	65	71	77	79	82	84	85	74	89
HCF 80 T4 3kW (A5:6) F400 (35°)	Inlet	62	69	74	79	82	82	86	76	89
HCF 80 T4 3kW (A5:6) F400 (32.5°)	Inlet	63	70	75	81	85	84	88	80	91
HCF 80 T4 3kW (A5:6) F400 (30°)	Inlet	64	71	76	83	87	86	90	83	94
HCF 80 T4 4kW (A5:6) F400 (37.5°)	Inlet	64	71	76	80	83	83	86	76	90
HCF 80 T4 4kW (A5:6) F400 (40°)	Inlet	66	73	78	82	84	84	86	76	91
HCF 90 T4 3kW (A3:4) F400 (22°)	Inlet	61	69	74	83	87	87	86	77	92
HCF 90 T4 3kW (A3:4) F400 (20°)	Inlet	57	68	73	84	88	88	86	78	93
HCF 90 T4 4kW (A3:4) F400 (26°)	Inlet	64	71	76	83	85	85	84	76	91
HCF 90 T4 4kW (A3:4) F400 (24°)	Inlet	63	70	75	83	86	86	85	77	91
HCF 90 T4 5,5kW (A3:4) F400 (30°)	Inlet	66	73	78	83	83	83	83	75	89
HCF 90 T4 5,5kW (A3:4) F400 (28°)	Inlet	65	72	77	83	84	84	84	76	90
HCF 90 T4 5,5kW (A3:4) F400 (32°)	Inlet	66	73	78	82	83	83	83	75	89
HCF 90 T4 5,5kW (A3:8) F400 (22°)	Inlet	69	80	88	90	92	87	88	78	97

Sound power Lw dB (A)										
Model		63 Hz	125 Hz	250 Hz	500 Hz	1000 Hz	2000 Hz	4000 Hz	8000 Hz	Total
HCF 90 T4 5,5kW (A3:8) F400 (20°)	Inlet	69	81	90	91	93	87	88	78	98
HCF 90 T4 5,5kW (A3:8) F400 (24°)	Inlet	69	79	86	89	91	88	88	78	96
HCF 90 T4 7,5kW (A3:4) F400 (34°)	Inlet	65	72	77	81	83	84	82	74	89
HCF 90 T4 7,5kW (A3:4) F400 (38°)	Inlet	67	74	79	82	85	84	83	76	91
HCF 90 T4 7,5kW (A3:4) F400 (36°)	Inlet	66	73	78	81	84	84	82	74	90
HCF 90 T4 7,5kW (A3:8) F400 (28°)	Inlet	70	76	82	87	89	88	87	79	94
HCF 90 T4 7,5kW (A3:8) F400 (26°)	Inlet	70	78	84	88	90	88	88	79	95
HCF 90 T4 11kW (A3:4) F400 (40°)	Inlet	68	75	80	83	87	85	84	77	91
HCF 90 T4 11kW (A3:8) F400 (36°)	Inlet	67	74	79	83	87	87	85	77	92
HCF 90 T4 11kW (A3:8) F400 (34°)	Inlet	67	74	79	84	87	87	85	77	92
HCF 90 T4 11kW (A3:8) F400 (32°)	Inlet	67	74	79	85	87	87	86	78	93
HCF 90 T4 11kW (A3:8) F400 (30°)	Inlet	68	75	80	86	88	88	87	79	94
HCF 90 T4 15kW (A3:8) F400 (40°)	Inlet	71	78	83	84	88	87	84	78	93
HCF 90 T4 15kW (A3:8) F400 (38°)	Inlet	69	76	81	84	87	87	84	77	92
HCF 100 T4 5,5kW (A3:4) F400 (26°)	Inlet	67	75	81	87	90	91	93	88	97
HCF 100 T4 5,5kW (A3:4) F400 (24°)	Inlet	67	76	81	87	91	92	93	89	98
HCF 100 T4 5,5kW (A3:4) F400 (22°)	Inlet	66	76	82	88	91	92	93	90	98
HCF 100 T4 5,5kW (A3:4) F400 (20°)	Inlet	66	76	81	88	91	92	93	90	98
HCF 100 T4 7,5kW (A3:4) F400 (30°)	Inlet	68	74	81	86	90	91	93	86	97
HCF 100 T4 7,5kW (A3:4) F400 (28°)	Inlet	67	75	81	86	90	91	93	87	97
HCF 100 T4 7,5kW (A3:8) F400 (20°)	Inlet	72	81	92	102	100	99	100	95	107
HCF 100 T4 11kW (A3:4) F400 (38°)	Inlet	68	74	81	86	89	90	92	85	96
HCF 100 T4 11kW (A3:4) F400 (36°)	Inlet	69	73	81	86	88	90	91	85	96
HCF 100 T4 11kW (A3:4) F400 (34°)	Inlet	69	73	81	85	88	90	91	85	96
HCF 100 T4 11kW (A3:4) F400 (32°)	Inlet	68	74	81	86	89	90	92	86	96
HCF 100 T4 11kW (A3:8) F400 (28°)	Inlet	72	79	87	93	96	95	96	91	102
HCF 100 T4 11kW (A3:8) F400 (24°)	Inlet	72	79	89	97	97	97	98	93	104
HCF 100 T4 11kW (A3:8) F400 (22°)	Inlet	72	80	91	100	99	98	99	94	106
HCF 100 T4 11kW (A3:8) F400 (26°)	Inlet	72	79	88	95	96	96	97	92	103
HCF 100 T4 15kW (A3:4) F400 (40°)	Inlet	68	75	81	87	90	91	92	86	97
HCF 100 T4 15kW (A3:8) F400 (34°)	Inlet	71	78	83	88	92	93	94	88	99
HCF 100 T4 15kW (A3:8) F400 (32°)	Inlet	71	79	84	90	93	94	95	89	100
HCF 100 T4 15kW (A3:8) F400 (30°)	Inlet	72	79	86	91	95	95	96	90	101
HCF 100 T4 18,5kW (A3:8) F400 (38°)	Inlet	71	78	83	88	92	94	94	88	99
HCF 100 T4 18,5kW (A3:8) F400 (36°)	Inlet	70	77	82	87	91	93	94	87	99
HCF 100 T4 22kW (A3:8) F400 (40°)	Inlet	71	79	84	89	92	94	95	89	100
HCF 112 T4 5,5kW (A3:4) F400 (20°)	Inlet	66	78	83	90	94	94	96	92	101
HCF 112 T4 7,5kW (A3:4) F400 (22°)	Inlet	68	79	84	90	94	95	96	92	102
HCF 112 T4 7,5kW (A3:4) F400 (24°)	Inlet	69	78	83	90	93	94	96	91	101

Sound power Lw dB (A)

Model		63 Hz	125 Hz	250 Hz	500 Hz	1000 Hz	2000 Hz	4000 Hz	8000 Hz	Total
HCF 112 T4 11kW (A3:4) F400 (32°)	Inlet	70	77	82	87	91	92	94	87	98
HCF 112 T4 11kW (A3:4) F400 (30°)	Inlet	71	78	83	88	92	93	94	88	99
HCF 112 T4 11kW (A3:4) F400 (28°)	Inlet	71	78	83	89	92	93	95	89	99
HCF 112 T4 11kW (A3:4) F400 (26°)	Inlet	70	78	83	89	93	94	95	90	100
HCF 112 T4 11kW (A3:8) F400 (22°)	Inlet	73	81	91	99	100	102	102	96	107
HCF 112 T4 11kW (A3:8) F400 (20°)	Inlet	73	82	92	101	101	103	103	97	109
HCF 112 T4 15kW (A3:4) F400 (38°)	Inlet	71	77	83	88	91	92	93	87	98
HCF 112 T4 15kW (A3:4) F400 (34°)	Inlet	70	76	82	87	90	92	93	86	98
HCF 112 T4 15kW (A3:4) F400 (36°)	Inlet	71	76	83	87	90	92	93	86	98
HCF 112 T4 15kW (A3:8) F400 (26°)	Inlet	74	81	89	96	98	100	100	94	106
HCF 112 T4 15kW (A3:8) F400 (24°)	Inlet	73	81	90	97	99	101	101	95	106
HCF 112 T4 15kW (A3:8) F400 (28°)	Inlet	74	81	88	94	98	99	99	94	105
HCF 112 T4 18,5kW (A3:4) F400 (40°)	Inlet	72	79	84	89	91	93	94	87	99
HCF 112 T4 18,5kW (A3:8) F400 (32°)	Inlet	74	81	86	91	96	97	97	91	103
HCF 112 T4 18,5kW (A3:8) F400 (30°)	Inlet	74	80	87	93	97	99	99	93	104
HCF 112 T4 22kW (A3:8) F400 (34°)	Inlet	73	80	85	90	94	96	96	89	101
HCF 112 T4 22kW (A3:8) F400 (36°)	Inlet	73	80	85	90	93	95	95	89	101
HCF 112 T4 30kW (A3:8) F400 (40°)	Inlet	74	81	86	90	94	96	95	90	101
HCF 112 T4 30kW (A3:8) F400 (38°)	Inlet	73	80	85	90	94	96	95	89	101
HCF 125 T4 11kW (A3:4) F400 (22°)	Inlet	75	86	91	98	102	103	105	101	109
HCF 125 T4 11kW (A3:4) F400 (20°)	Inlet	72	85	90	98	102	102	104	101	109
HCF 125 T4 15kW (A3:4) F400 (28°)	Inlet	75	82	87	93	96	98	99	93	104
HCF 125 T4 15kW (A3:4) F400 (26°)	Inlet	76	84	89	94	98	99	101	95	106
HCF 125 T4 15kW (A3:4) F400 (24°)	Inlet	75	85	90	96	100	101	103	98	107
HCF 125 T4 18,5kW (A3:4) F400 (32°)	Inlet	74	81	86	90	94	96	96	90	102
HCF 125 T4 18,5kW (A3:4) F400 (30°)	Inlet	74	81	86	91	95	96	97	91	102
HCF 125 T4 18,5kW (A3:8) F400 (22°)	Inlet	79	86	93	102	107	110	109	104	114
HCF 125 T4 18,5kW (A3:8) F400 (20°)	Inlet	78	86	93	103	108	111	110	105	115
HCF 125 T4 22kW (A3:4) F400 (36°)	Inlet	74	81	86	90	93	95	96	88	101
HCF 125 T4 22kW (A3:4) F400 (34°)	Inlet	73	80	85	90	93	95	96	88	101
HCF 125 T4 22kW (A3:8) F400 (24°)	Inlet	78	85	92	100	106	108	108	102	113
HCF 125 T4 22kW (A3:8) F400 (26°)	Inlet	78	85	91	98	104	106	106	100	111
HCF 125 T4 30kW (A3:4) F400 (40°)	Inlet	75	82	87	91	93	96	96	89	102
HCF 125 T4 30kW (A3:4) F400 (38°)	Inlet	74	81	86	91	93	95	96	89	101
HCF 125 T4 30kW (A3:8) F400 (30°)	Inlet	77	83	90	96	101	103	104	97	108
HCF 125 T4 30kW (A3:8) F400 (28°)	Inlet	78	84	91	97	102	105	105	98	110
HCF 125 T4 30kW (A3:8) F400 (32°)	Inlet	77	83	89	95	99	102	102	94	107
HCF 125 T4 37kW (A3:8) F400 (36°)	Inlet	77	83	89	93	96	98	98	91	104
HCF 125 T4 37kW (A3:8) F400 (34°)	Inlet	77	83	89	94	97	99	100	92	105

Sound power Lw dB (A)										
Model		63 Hz	125 Hz	250 Hz	500 Hz	1000 Hz	2000 Hz	4000 Hz	8000 Hz	Total
HCF 125 T4 45kW (A3:8) F400 (40°)	Inlet	76	83	88	93	96	98	97	90	103
HCF 125 T4 45kW (A3:8) F400 (38°)	Inlet	76	83	88	93	96	98	97	91	104

Sound / 6 poles

Sound power Lw dB (A)										
Model		63 Hz	125 Hz	250 Hz	500 Hz	1000 Hz	2000 Hz	4000 Hz	8000 Hz	Total
HCF 50 T6 0,75kW (A5:6) F400 (40°)	Inlet	44	51	56	60	63	62	64	57	69
HCF 56 T6 0,75kW (A5:6) F400 (40°)	Inlet	47	54	59	67	66	67	70	61	74
HCF 63 T6 0,75kW (A5:6) F400 (40°)	Inlet	51	58	63	68	69	69	71	64	76
HCF 71 T6 0,75kW (A5:6) F400 (40°)	Inlet	59	65	71	73	76	77	78	68	83
HCF 71 T6 0,75kW (A5:6) F400 (37.5°)	Inlet	56	63	68	70	73	75	76	65	81
HCF 71 T6 0,75kW (A5:6) F400 (35°)	Inlet	54	61	66	67	71	73	74	63	79
HCF 80 T6 0,75kW (A5:6) F400 (30°)	Inlet	55	62	67	74	78	77	81	74	85
HCF 80 T6 1,1kW (A5:6) F400 (32.5°)	Inlet	54	61	66	72	76	75	79	71	83
HCF 80 T6 1,1kW (A5:6) F400 (35°)	Inlet	53	60	65	70	73	74	77	67	81
HCF 80 T6 1,5kW (A5:6) F400 (37.5°)	Inlet	55	62	67	71	74	75	77	68	81
HCF 80 T6 1,5kW (A5:6) F400 (40°)	Inlet	57	64	69	73	75	76	77	68	82
HCF 80 T6 2,2kW (A5:6) F400 (42.5°)	Inlet	58	65	70	74	76	76	77	68	82
HCF 90 T6 1,5kW (A3:4) F400 (20°)	Inlet	47	58	63	74	78	78	77	69	83
HCF 90 T6 1,5kW (A3:4) F400 (26°)	Inlet	55	62	67	74	75	75	75	67	81
HCF 90 T6 1,5kW (A3:4) F400 (22°)	Inlet	51	60	65	74	77	77	76	68	83
HCF 90 T6 1,5kW (A3:4) F400 (30°)	Inlet	57	64	69	73	73	73	74	66	80
HCF 90 T6 1,5kW (A3:4) F400 (24°)	Inlet	54	61	66	74	76	76	76	67	82
HCF 90 T6 1,5kW (A3:4) F400 (32°)	Inlet	57	64	69	73	74	74	73	65	80
HCF 90 T6 1,5kW (A3:4) F400 (28°)	Inlet	56	63	68	73	74	74	74	66	81
HCF 90 T6 1,5kW (A3:8) F400 (24°)	Inlet	60	69	77	80	82	78	78	69	86
HCF 90 T6 1,5kW (A3:8) F400 (22°)	Inlet	60	71	79	81	83	78	78	69	87
HCF 90 T6 1,5kW (A3:8) F400 (20°)	Inlet	60	72	81	82	84	78	79	69	88
HCF 90 T6 2,2kW (A3:4) F400 (36°)	Inlet	56	63	68	72	75	75	73	65	80
HCF 90 T6 2,2kW (A3:4) F400 (40°)	Inlet	59	66	71	73	77	75	74	67	82
HCF 90 T6 2,2kW (A3:4) F400 (38°)	Inlet	58	65	70	73	76	75	74	66	81
HCF 90 T6 2,2kW (A3:4) F400 (34°)	Inlet	56	63	68	72	74	74	73	65	80
HCF 90 T6 2,2kW (A3:8) F400 (30°)	Inlet	59	66	71	77	79	79	78	70	84
HCF 90 T6 2,2kW (A3:8) F400 (28°)	Inlet	60	67	73	78	80	78	78	70	85
HCF 90 T6 2,2kW (A3:8) F400 (26°)	Inlet	60	68	75	79	81	78	78	69	86
HCF 90 T6 3kW (A3:8) F400 (36°)	Inlet	58	65	70	74	77	77	75	68	83
HCF 90 T6 3kW (A3:8) F400 (34°)	Inlet	57	64	69	74	77	78	76	68	83

Sound power Lw dB (A)										
Model		63 Hz	125 Hz	250 Hz	500 Hz	1000 Hz	2000 Hz	4000 Hz	8000 Hz	Total
HCF 90 T6 3kW (A3:8) F400 (32°)	Inlet	58	65	70	76	78	78	77	69	84
HCF 90 T6 4kW (A3:8) F400 (40°)	Inlet	61	68	73	75	79	78	75	68	84
HCF 90 T6 4kW (A3:8) F400 (38°)	Inlet	59	66	71	74	78	78	75	68	83
HCF 100 T6 1,5kW (A3:4) F400 (26°)	Inlet	57	66	71	77	81	82	83	78	88
HCF 100 T6 1,5kW (A3:4) F400 (20°)	Inlet	56	67	72	78	82	83	84	81	89
HCF 100 T6 1,5kW (A3:4) F400 (24°)	Inlet	57	66	72	78	82	82	84	79	89
HCF 100 T6 1,5kW (A3:4) F400 (22°)	Inlet	57	67	72	78	82	83	84	80	89
HCF 100 T6 2,2kW (A3:4) F400 (26°)	Inlet	57	66	71	77	81	82	83	78	88
HCF 100 T6 2,2kW (A3:4) F400 (20°)	Inlet	56	67	72	78	82	83	84	81	89
HCF 100 T6 2,2kW (A3:4) F400 (32°)	Inlet	59	64	71	76	79	81	83	76	87
HCF 100 T6 2,2kW (A3:4) F400 (30°)	Inlet	58	65	71	77	80	81	83	77	87
HCF 100 T6 2,2kW (A3:4) F400 (28°)	Inlet	58	65	71	77	81	81	83	78	88
HCF 100 T6 2,2kW (A3:4) F400 (24°)	Inlet	57	66	72	78	82	82	84	79	89
HCF 100 T6 2,2kW (A3:4) F400 (22°)	Inlet	57	67	72	78	82	83	84	80	89
HCF 100 T6 2,2kW (A3:8) F400 (22°)	Inlet	63	71	82	90	89	88	89	85	96
HCF 100 T6 2,2kW (A3:8) F400 (20°)	Inlet	63	71	83	92	91	89	90	86	97
HCF 100 T6 3kW (A3:4) F400 (38°)	Inlet	59	65	72	77	80	81	82	76	87
HCF 100 T6 3kW (A3:4) F400 (34°)	Inlet	59	63	71	76	79	80	82	76	86
HCF 100 T6 3kW (A3:4) F400 (36°)	Inlet	59	64	71	76	79	80	82	76	86
HCF 100 T6 3kW (A3:8) F400 (24°)	Inlet	62	70	80	88	88	87	88	83	94
HCF 100 T6 3kW (A3:8) F400 (28°)	Inlet	62	70	78	84	86	86	87	81	92
HCF 100 T6 3kW (A3:8) F400 (26°)	Inlet	62	70	79	86	87	87	87	82	93
HCF 100 T6 4kW (A3:4) F400 (40°)	Inlet	59	66	72	77	81	81	83	76	87
HCF 100 T6 4kW (A3:8) F400 (34°)	Inlet	61	68	73	78	82	84	85	78	89
HCF 100 T6 4kW (A3:8) F400 (32°)	Inlet	62	69	75	80	84	85	85	79	90
HCF 100 T6 4kW (A3:8) F400 (30°)	Inlet	62	69	77	82	85	86	86	80	92
HCF 100 T6 5,5kW (A3:8) F400 (36°)	Inlet	61	68	73	78	82	84	84	78	89
HCF 100 T6 5,5kW (A3:8) F400 (40°)	Inlet	62	69	74	79	83	85	85	79	90
HCF 100 T6 5,5kW (A3:8) F400 (38°)	Inlet	61	68	73	79	82	84	85	79	90
HCF 112 T6 2,2kW (A3:4) F400 (26°)	Inlet	60	69	74	80	83	84	86	80	90
HCF 112 T6 2,2kW (A3:4) F400 (24°)	Inlet	59	69	74	80	84	85	86	81	91
HCF 112 T6 2,2kW (A3:4) F400 (22°)	Inlet	58	69	74	81	85	85	87	82	92
HCF 112 T6 2,2kW (A3:4) F400 (20°)	Inlet	56	68	73	80	84	85	87	82	91
HCF 112 T6 3kW (A3:4) F400 (28°)	Inlet	61	68	73	79	83	84	85	79	90
HCF 112 T6 3kW (A3:4) F400 (32°)	Inlet	61	67	73	78	81	83	84	78	89
HCF 112 T6 3kW (A3:4) F400 (30°)	Inlet	61	68	73	79	82	83	85	78	89
HCF 112 T6 3kW (A3:8) F400 (22°)	Inlet	64	72	81	89	90	92	92	87	98
HCF 112 T6 3kW (A3:8) F400 (20°)	Inlet	64	72	82	91	91	93	93	88	99
HCF 112 T6 4kW (A3:4) F400 (38°)	Inlet	62	68	74	78	81	83	84	77	89

Sound power Lw dB (A)										
Model		63 Hz	125 Hz	250 Hz	500 Hz	1000 Hz	2000 Hz	4000 Hz	8000 Hz	Total
HCF 112 T6 4kW (A3:4) F400 (36°)	Inlet	61	67	73	78	81	82	84	77	88
HCF 112 T6 4kW (A3:4) F400 (34°)	Inlet	61	66	73	78	81	82	84	77	88
HCF 112 T6 4kW (A3:8) F400 (28°)	Inlet	64	71	79	85	89	90	90	84	95
HCF 112 T6 4kW (A3:8) F400 (26°)	Inlet	64	71	79	86	89	90	90	85	96
HCF 112 T6 4kW (A3:8) F400 (24°)	Inlet	64	71	80	88	90	91	91	86	96
HCF 112 T6 5,5kW (A3:4) F400 (40°)	Inlet	63	69	75	79	82	84	84	78	89
HCF 112 T6 5,5kW (A3:8) F400 (30°)	Inlet	65	71	78	83	88	89	89	84	94
HCF 112 T6 5,5kW (A3:8) F400 (34°)	Inlet	64	71	76	81	84	86	87	80	92
HCF 112 T6 5,5kW (A3:8) F400 (32°)	Inlet	64	71	77	82	86	88	88	82	93
HCF 112 T6 7,5kW (A3:8) F400 (38°)	Inlet	64	71	76	81	84	86	86	80	91
HCF 112 T6 7,5kW (A3:8) F400 (36°)	Inlet	63	70	75	80	84	86	86	79	91
HCF 112 T6 7,5kW (A3:8) F400 (40°)	Inlet	64	71	76	81	85	87	86	80	92
HCF 125 T6 3kW (A3:4) F400 (24°)	Inlet	66	75	80	87	90	91	93	88	98
HCF 125 T6 3kW (A3:4) F400 (22°)	Inlet	65	77	82	89	92	93	95	91	99
HCF 125 T6 3kW (A3:4) F400 (20°)	Inlet	63	76	81	89	92	92	94	91	99
HCF 125 T6 4kW (A3:4) F400 (26°)	Inlet	66	74	79	85	89	90	91	86	96
HCF 125 T6 4kW (A3:4) F400 (28°)	Inlet	66	73	78	83	87	88	89	84	94
HCF 125 T6 5,5kW (A3:4) F400 (34°)	Inlet	64	71	76	81	84	85	86	79	91
HCF 125 T6 5,5kW (A3:4) F400 (32°)	Inlet	64	71	76	81	84	86	87	80	92
HCF 125 T6 5,5kW (A3:4) F400 (30°)	Inlet	65	72	77	81	85	87	88	81	92
HCF 125 T6 5,5kW (A3:8) F400 (24°)	Inlet	69	76	83	90	96	98	98	92	103
HCF 125 T6 5,5kW (A3:8) F400 (22°)	Inlet	69	77	84	92	97	100	99	94	105
HCF 125 T6 5,5kW (A3:8) F400 (20°)	Inlet	69	77	84	93	98	101	101	95	106
HCF 125 T6 7,5kW (A3:4) F400 (40°)	Inlet	65	72	77	82	84	86	87	80	92
HCF 125 T6 7,5kW (A3:4) F400 (38°)	Inlet	65	72	77	81	84	86	86	79	91
HCF 125 T6 7,5kW (A3:4) F400 (36°)	Inlet	64	71	76	81	83	85	86	79	91
HCF 125 T6 7,5kW (A3:8) F400 (30°)	Inlet	68	74	80	86	91	93	94	87	98
HCF 125 T6 7,5kW (A3:8) F400 (28°)	Inlet	68	74	81	87	93	95	95	89	100
HCF 125 T6 7,5kW (A3:8) F400 (26°)	Inlet	69	75	82	89	94	97	96	90	102
HCF 125 T6 11kW (A3:8) F400 (38°)	Inlet	67	74	79	84	87	89	88	81	94
HCF 125 T6 11kW (A3:8) F400 (36°)	Inlet	67	74	79	84	87	89	89	82	94
HCF 125 T6 11kW (A3:8) F400 (34°)	Inlet	68	74	80	84	88	90	90	83	95
HCF 125 T6 11kW (A3:8) F400 (32°)	Inlet	68	74	80	85	90	92	92	85	97
HCF 125 T6 15kW (A3:8) F400 (40°)	Inlet	67	74	79	83	87	89	87	81	93

Sound / 4/8 poles

Sound power Lw dB (A)										
Model		63 Hz	125 Hz	250 Hz	500 Hz	1000 Hz	2000 Hz	4000 Hz	8000 Hz	Total



Sound power Lw dB (A)										
Model		63 Hz	125 Hz	250 Hz	500 Hz	1000 Hz	2000 Hz	4000 Hz	8000 Hz	Total
HCF 45 T4/T8 0,8/0,2kW (A5:6) F400 (1500 RPM - 40°)	Inlet	50	57	62	67	70	70	71	64	76
HCF 45 T4/T8 0,8/0,2kW (A5:6) F400 (750 RPM - 40°)	Inlet	35	42	47	52	55	55	56	49	61
HCF 50 T4/T8 0,8/0,2kW (A5:6) F400 (750 RPM - 40°)	Inlet	38	45	50	54	57	56	57	51	63
HCF 50 T4/T8 0,8/0,2kW (A5:6) F400 (1500 RPM - 40°)	Inlet	53	60	65	69	72	71	72	66	78
HCF 56 T4/T8 0,8/0,2kW (A5:6) F400 (750 RPM - 32.5°)	Inlet	39	46	51	60	60	61	64	55	68
HCF 56 T4/T8 0,8/0,2kW (A5:6) F400 (750 RPM - 25°)	Inlet	39	47	52	60	64	61	63	55	69
HCF 56 T4/T8 0,8/0,2kW (A5:6) F400 (750 RPM - 30°)	Inlet	41	48	53	62	63	62	65	57	69
HCF 56 T4/T8 0,8/0,2kW (A5:6) F400 (1500 RPM - 25°)	Inlet	54	62	67	75	79	76	78	70	84
HCF 56 T4/T8 0,8/0,2kW (A5:6) F400 (1500 RPM - 32.5°)	Inlet	54	61	66	75	75	76	79	70	83
HCF 56 T4/T8 0,8/0,2kW (A5:6) F400 (1500 RPM - 30°)	Inlet	56	63	68	77	78	78	80	72	85
HCF 56 T4/T8 1,2/0,3kW (A5:6) F400 (750 RPM - 37.5°)	Inlet	39	46	51	59	59	60	63	54	67
HCF 56 T4/T8 1,2/0,3kW (A5:6) F400 (750 RPM - 35°)	Inlet	38	45	50	58	58	60	62	54	66
HCF 56 T4/T8 1,2/0,3kW (A5:6) F400 (1500 RPM - 37.5°)	Inlet	54	61	66	75	74	76	78	69	82
HCF 56 T4/T8 1,2/0,3kW (A5:6) F400 (1500 RPM - 35°)	Inlet	53	60	65	74	73	75	78	69	82
HCF 56 T4/T8 1,6/0,4kW (A5:6) F400 (750 RPM - 40°)	Inlet	41	48	53	60	60	61	63	55	68
HCF 56 T4/T8 1,6/0,4kW (A5:6) F400 (750 RPM - 42.5°)	Inlet	43	50	55	61	61	62	64	55	69
HCF 56 T4/T8 1,6/0,4kW (A5:6) F400 (1500 RPM - 40°)	Inlet	56	63	68	76	75	76	79	70	83
HCF 56 T4/T8 1,6/0,4kW (A5:6) F400 (1500 RPM - 42.5°)	Inlet	58	65	70	76	76	77	79	70	84
HCF 63 T4/T8 0,8/0,2kW (A5:6) F400 (750 RPM - 25°)	Inlet	42	51	56	65	65	64	65	60	71
HCF 63 T4/T8 0,8/0,2kW (A5:6) F400 (1500 RPM - 25°)	Inlet	57	66	71	80	80	79	80	75	86
HCF 63 T4/T8 1,2/0,3kW (A5:6) F400 (750 RPM - 30°)	Inlet	45	53	59	65	65	64	67	62	72
HCF 63 T4/T8 1,2/0,3kW (A5:6) F400 (1500 RPM - 30°)	Inlet	60	68	74	80	80	79	82	77	87
HCF 63 T4/T8 1,6/0,4kW (A5:6) F400 (750 RPM - 35°)	Inlet	43	52	57	60	61	60	64	58	68

Sound power Lw dB (A)										
Model		63 Hz	125 Hz	250 Hz	500 Hz	1000 Hz	2000 Hz	4000 Hz	8000 Hz	Total
HCF 63 T4/T8 1,6/0,4kW (A5:6) F400 (1500 RPM - 35°)	Inlet	59	67	72	75	76	76	79	73	83
HCF 63 T4/T8 1,6/0,4kW (A5:6) F400 (750 RPM - 32.5°)	Inlet	44	52	58	62	63	62	65	60	70
HCF 63 T4/T8 1,6/0,4kW (A5:6) F400 (1500 RPM - 32.5°)	Inlet	59	68	73	77	78	77	80	75	85
HCF 63 T4/T8 2,2/0,37kW (A5:6) F400 (750 RPM - 37.5°)	Inlet	44	52	57	61	62	62	64	58	69
HCF 63 T4/T8 2,2/0,37kW (A5:6) F400 (750 RPM - 40°)	Inlet	45	52	57	62	62	63	65	58	70
HCF 63 T4/T8 2,2/0,37kW (A5:6) F400 (1500 RPM - 40°)	Inlet	60	67	72	77	78	78	80	73	85
HCF 63 T4/T8 2,2/0,37kW (A5:6) F400 (1500 RPM - 37.5°)	Inlet	59	67	72	76	77	77	79	73	84
HCF 71 T4/T8 0,8/0,2kW (A5:6) F400 (750 RPM - 20°)	Inlet	40	51	56	71	70	67	69	61	76
HCF 71 T4/T8 0,8/0,2kW (A5:6) F400 (1500 RPM - 20°)	Inlet	55	66	71	86	85	82	84	76	91
HCF 71 T4/T8 1,2/0,3kW (A5:6) F400 (750 RPM - 25°)	Inlet	44	51	56	69	68	67	69	60	75
HCF 71 T4/T8 1,2/0,3kW (A5:6) F400 (1500 RPM - 25°)	Inlet	59	67	72	84	84	82	84	75	90
HCF 71 T4/T8 1,6/0,4kW (A5:6) F400 (750 RPM - 30°)	Inlet	46	53	58	67	67	68	69	58	74
HCF 71 T4/T8 1,6/0,4kW (A5:6) F400 (1500 RPM - 30°)	Inlet	61	68	73	82	82	83	84	73	89
HCF 71 T4/T8 2,2/0,37kW (A5:6) F400 (750 RPM - 35°)	Inlet	47	54	59	61	65	67	68	57	72
HCF 71 T4/T8 2,2/0,37kW (A5:6) F400 (750 RPM - 32.5°)	Inlet	46	53	58	64	66	68	68	58	73
HCF 71 T4/T8 2,2/0,37kW (A5:6) F400 (1500 RPM - 35°)	Inlet	62	69	74	76	80	82	83	72	87
HCF 71 T4/T8 2,2/0,37kW (A5:6) F400 (1500 RPM - 32.5°)	Inlet	62	69	74	79	81	83	84	73	88
HCF 71 T4/T8 3/0,55kW (A5:6) F400 (750 RPM - 40°)	Inlet	52	58	64	66	69	70	71	61	76
HCF 71 T4/T8 3/0,55kW (A5:6) F400 (750 RPM - 37.5°)	Inlet	50	56	62	64	67	69	70	59	74
HCF 71 T4/T8 3/0,55kW (A5:6) F400 (1500 RPM - 40°)	Inlet	67	73	79	81	84	85	86	76	91
HCF 71 T4/T8 3/0,55kW (A5:6) F400 (1500 RPM - 37.5°)	Inlet	65	71	77	79	82	84	85	74	89
HCF 80 T4/T8 3/0,55kW (A5:6) F400 (750 RPM - 35°)	Inlet	47	54	59	64	67	67	71	61	74
HCF 80 T4/T8 3/0,55kW (A5:6) F400 (1500 RPM - 35°)	Inlet	62	69	74	79	82	82	86	76	89

		Sound power Lw dB (A)								
Model		63 Hz	125 Hz	250 Hz	500 Hz	1000 Hz	2000 Hz	4000 Hz	8000 Hz	Total
HCF 80 T4/T8 3/0,55kW (A5:6) F400 (750 RPM - 32.5°)	Inlet	48	55	60	66	69	69	73	64	76
HCF 80 T4/T8 3/0,55kW (A5:6) F400 (1500 RPM - 32.5°)	Inlet	63	70	75	81	85	84	88	80	91
HCF 80 T4/T8 3/0,55kW (A5:6) F400 (1500 RPM - 30°)	Inlet	64	71	76	83	87	86	90	83	94
HCF 80 T4/T8 3/0,55kW (A5:6) F400 (750 RPM - 30°)	Inlet	49	56	61	68	72	71	74	68	79
HCF 80 T4/T8 4/0,75kW (A5:6) F400 (750 RPM - 37.5°)	Inlet	49	56	61	65	68	68	71	61	75
HCF 80 T4/T8 4/0,75kW (A5:6) F400 (1500 RPM - 37.5°)	Inlet	64	71	76	80	83	83	86	76	90
HCF 80 T4/T8 4/0,75kW (A5:6) F400 (750 RPM - 40°)	Inlet	51	58	63	67	69	69	70	61	76
HCF 80 T4/T8 4/0,75kW (A5:6) F400 (1500 RPM - 40°)	Inlet	66	73	78	82	84	84	86	76	91
HCF 90 T4/T8 2,8/0,7kW (A3:4) F400 (1420 RPM - 22°)	Inlet	61	69	74	83	87	87	86	77	92
HCF 90 T4/T8 2,8/0,7kW (A3:4) F400 (1420 RPM - 20°)	Inlet	57	68	73	84	88	88	86	78	93
HCF 90 T4/T8 2,8/0,7kW (A3:4) F400 (720 RPM - 22°)	Inlet	45	53	58	67	71	71	70	62	76
HCF 90 T4/T8 2,8/0,7kW (A3:4) F400 (720 RPM - 20°)	Inlet	41	52	57	68	72	72	70	62	77
HCF 90 T4/T8 4/0,75kW (A3:4) F400 (1420 RPM - 26°)	Inlet	64	71	76	83	85	85	84	76	91
HCF 90 T4/T8 4/0,75kW (A3:4) F400 (1420 RPM - 24°)	Inlet	63	70	75	83	86	86	85	77	91
HCF 90 T4/T8 4/0,75kW (A3:4) F400 (720 RPM - 26°)	Inlet	48	55	60	67	69	69	68	60	75
HCF 90 T4/T8 4/0,75kW (A3:4) F400 (720 RPM - 24°)	Inlet	47	54	59	67	70	70	69	61	75
HCF 90 T4/T8 5,5/1,1kW (A3:4) F400 (1420 RPM - 30°)	Inlet	66	73	78	83	83	83	83	75	89
HCF 90 T4/T8 5,5/1,1kW (A3:4) F400 (1420 RPM - 28°)	Inlet	65	72	77	83	84	84	84	76	90
HCF 90 T4/T8 5,5/1,1kW (A3:4) F400 (1420 RPM - 32°)	Inlet	66	73	78	82	83	83	83	75	89
HCF 90 T4/T8 5,5/1,1kW (A3:4) F400 (720 RPM - 32°)	Inlet	50	57	62	66	67	67	67	59	73
HCF 90 T4/T8 5,5/1,1kW (A3:4) F400 (720 RPM - 30°)	Inlet	51	58	63	67	67	67	67	59	74
HCF 90 T4/T8 5,5/1,1kW (A3:4) F400 (720 RPM - 28°)	Inlet	49	56	61	67	68	68	68	60	74
HCF 90 T4/T8 5,5/1,1kW (A3:8) F400 (1420 RPM - 22°)	Inlet	69	80	88	90	92	87	88	78	97



		Sound power Lw dB (A)								
Model		63 Hz	125 Hz	250 Hz	500 Hz	1000 Hz	2000 Hz	4000 Hz	8000 Hz	Total
HCF 90 T4/T8 5,5/1,1kW (A3:8) F400 (1420 RPM - 20°)	Inlet	69	81	90	91	93	87	88	78	98
HCF 90 T4/T8 5,5/1,1kW (A3:8) F400 (720 RPM - 22°)	Inlet	53	64	72	74	76	72	72	62	81
HCF 90 T4/T8 5,5/1,1kW (A3:8) F400 (720 RPM - 20°)	Inlet	53	65	74	75	77	71	72	62	82
HCF 90 T4/T8 7,5/1,5kW (A3:4) F400 (1420 RPM - 34°)	Inlet	65	72	77	81	83	84	82	74	89
HCF 90 T4/T8 7,5/1,5kW (A3:4) F400 (1420 RPM - 38°)	Inlet	67	74	79	82	85	84	83	76	91
HCF 90 T4/T8 7,5/1,5kW (A3:4) F400 (1420 RPM - 36°)	Inlet	66	73	78	81	84	84	82	74	90
HCF 90 T4/T8 7,5/1,5kW (A3:4) F400 (1420 RPM - 32°)	Inlet	66	73	78	82	83	83	83	75	89
HCF 90 T4/T8 7,5/1,5kW (A3:4) F400 (720 RPM - 38°)	Inlet	51	58	63	66	69	69	67	60	75
HCF 90 T4/T8 7,5/1,5kW (A3:4) F400 (720 RPM - 36°)	Inlet	50	57	62	66	68	68	67	58	74
HCF 90 T4/T8 7,5/1,5kW (A3:4) F400 (720 RPM - 34°)	Inlet	50	57	62	66	67	68	66	58	73
HCF 90 T4/T8 7,5/1,5kW (A3:4) F400 (720 RPM - 32°)	Inlet	50	57	62	66	67	67	67	59	73
HCF 90 T4/T8 7,5/1,5kW (A3:8) F400 (1420 RPM - 28°)	Inlet	70	76	82	87	89	88	87	79	94
HCF 90 T4/T8 7,5/1,5kW (A3:8) F400 (1420 RPM - 26°)	Inlet	70	78	84	88	90	88	88	79	95
HCF 90 T4/T8 7,5/1,5kW (A3:8) F400 (1420 RPM - 24°)	Inlet	69	79	86	89	91	88	88	78	96
HCF 90 T4/T8 7,5/1,5kW (A3:8) F400 (720 RPM - 28°)	Inlet	54	60	66	71	73	72	71	63	79
HCF 90 T4/T8 7,5/1,5kW (A3:8) F400 (720 RPM - 26°)	Inlet	54	62	68	72	74	72	72	63	79
HCF 90 T4/T8 7,5/1,5kW (A3:8) F400 (720 RPM - 24°)	Inlet	54	63	70	73	75	72	72	63	80
HCF 90 T4/T8 11/3kW (A3:4) F400 (1420 RPM - 40°)	Inlet	68	75	80	83	87	85	84	77	91
HCF 90 T4/T8 11/3kW (A3:4) F400 (720 RPM - 40°)	Inlet	52	59	64	67	71	69	68	61	75
HCF 90 T4/T8 11/3kW (A3:8) F400 (1420 RPM - 36°)	Inlet	67	74	79	83	87	87	85	77	92
HCF 90 T4/T8 11/3kW (A3:8) F400 (1420 RPM - 34°)	Inlet	67	74	79	84	87	87	85	77	92
HCF 90 T4/T8 11/3kW (A3:8) F400 (1420 RPM - 32°)	Inlet	67	74	79	85	87	87	86	78	93
HCF 90 T4/T8 11/3kW (A3:8) F400 (1420 RPM - 30°)	Inlet	68	75	80	86	88	88	87	79	94

		Sound power Lw dB (A)								
Model		63 Hz	125 Hz	250 Hz	500 Hz	1000 Hz	2000 Hz	4000 Hz	8000 Hz	Total
HCF 90 T4/T8 11/3kW (A3:8) F400 (720 RPM - 36°)	Inlet	51	58	63	67	71	71	69	61	76
HCF 90 T4/T8 11/3kW (A3:8) F400 (720 RPM - 34°)	Inlet	51	58	63	68	71	71	69	61	76
HCF 90 T4/T8 11/3kW (A3:8) F400 (720 RPM - 32°)	Inlet	52	59	64	69	71	72	70	62	77
HCF 90 T4/T8 11/3kW (A3:8) F400 (720 RPM - 30°)	Inlet	52	59	64	70	72	72	71	63	78
HCF 90 T4/T8 14/3,5kW (A3:8) F400 (1420 RPM - 40°)	Inlet	71	78	83	84	88	87	84	78	93
HCF 90 T4/T8 14/3,5kW (A3:8) F400 (1420 RPM - 38°)	Inlet	69	76	81	84	87	87	84	77	92
HCF 90 T4/T8 14/3,5kW (A3:8) F400 (720 RPM - 40°)	Inlet	55	62	67	68	72	71	68	62	77
HCF 90 T4/T8 14/3,5kW (A3:8) F400 (720 RPM - 38°)	Inlet	53	60	65	68	71	71	69	61	77
HCF 100 T4/T8 5,5/1,1kW (A3:4) F400 (1420 RPM - 26°)	Inlet	67	75	81	87	90	91	93	88	97
HCF 100 T4/T8 5,5/1,1kW (A3:4) F400 (1420 RPM - 24°)	Inlet	67	76	81	87	91	92	93	89	98
HCF 100 T4/T8 5,5/1,1kW (A3:4) F400 (1420 RPM - 22°)	Inlet	66	76	82	88	91	92	93	90	98
HCF 100 T4/T8 5,5/1,1kW (A3:4) F400 (1420 RPM - 20°)	Inlet	66	76	81	88	91	92	93	90	98
HCF 100 T4/T8 5,5/1,1kW (A3:4) F400 (720 RPM - 26°)	Inlet	51	59	65	71	74	75	77	72	82
HCF 100 T4/T8 5,5/1,1kW (A3:4) F400 (720 RPM - 24°)	Inlet	51	60	66	72	75	76	77	73	82
HCF 100 T4/T8 5,5/1,1kW (A3:4) F400 (720 RPM - 22°)	Inlet	50	60	66	72	76	76	77	74	82
HCF 100 T4/T8 5,5/1,1kW (A3:4) F400 (720 RPM - 20°)	Inlet	50	60	66	72	76	76	77	74	82
HCF 100 T4/T8 7,5/1,5kW (A3:4) F400 (1420 RPM - 30°)	Inlet	68	74	81	86	90	91	93	86	97
HCF 100 T4/T8 7,5/1,5kW (A3:4) F400 (1420 RPM - 28°)	Inlet	67	75	81	86	90	91	93	87	97
HCF 100 T4/T8 7,5/1,5kW (A3:4) F400 (720 RPM - 30°)	Inlet	52	59	65	70	74	75	77	70	81
HCF 100 T4/T8 7,5/1,5kW (A3:4) F400 (720 RPM - 28°)	Inlet	51	59	65	71	74	75	77	71	81
HCF 100 T4/T8 7,5/1,5kW (A3:8) F400 (1420 RPM - 20°)	Inlet	72	81	92	102	100	99	100	95	107
HCF 100 T4/T8 7,5/1,5kW (A3:8) F400 (720 RPM - 20°)	Inlet	56	65	76	86	84	83	84	79	91
HCF 100 T4/T8 11/3kW (A3:4) F400 (1420 RPM - 38°)	Inlet	68	74	81	86	89	90	92	85	96

		Sound power Lw dB (A)								
Model		63 Hz	125 Hz	250 Hz	500 Hz	1000 Hz	2000 Hz	4000 Hz	8000 Hz	Total
HCF 100 T4/T8 11/3kW (A3:4) F400 (1420 RPM - 36°)	Inlet	69	73	81	86	88	90	91	85	96
HCF 100 T4/T8 11/3kW (A3:4) F400 (1420 RPM - 34°)	Inlet	69	73	81	85	88	90	91	85	96
HCF 100 T4/T8 11/3kW (A3:4) F400 (1420 RPM - 32°)	Inlet	68	74	81	86	89	90	92	86	96
HCF 100 T4/T8 11/3kW (A3:4) F400 (720 RPM - 38°)	Inlet	52	58	65	70	73	74	76	69	80
HCF 100 T4/T8 11/3kW (A3:4) F400 (720 RPM - 36°)	Inlet	53	57	65	70	72	74	75	69	80
HCF 100 T4/T8 11/3kW (A3:4) F400 (720 RPM - 34°)	Inlet	53	57	65	69	72	74	76	69	80
HCF 100 T4/T8 11/3kW (A3:4) F400 (720 RPM - 32°)	Inlet	52	58	65	70	73	74	76	70	80
HCF 100 T4/T8 11/3kW (A3:8) F400 (1420 RPM - 28°)	Inlet	72	79	87	93	96	95	96	91	102
HCF 100 T4/T8 11/3kW (A3:8) F400 (1420 RPM - 24°)	Inlet	72	79	89	97	97	97	98	93	104
HCF 100 T4/T8 11/3kW (A3:8) F400 (1420 RPM - 22°)	Inlet	72	80	91	100	99	98	99	94	106
HCF 100 T4/T8 11/3kW (A3:8) F400 (1420 RPM - 26°)	Inlet	72	79	88	95	96	96	97	92	103
HCF 100 T4/T8 11/3kW (A3:8) F400 (720 RPM - 28°)	Inlet	56	63	71	77	80	80	80	75	86
HCF 100 T4/T8 11/3kW (A3:8) F400 (720 RPM - 26°)	Inlet	56	63	72	79	80	80	81	76	87
HCF 100 T4/T8 11/3kW (A3:8) F400 (720 RPM - 24°)	Inlet	56	64	73	81	82	81	82	77	88
HCF 100 T4/T8 11/3kW (A3:8) F400 (720 RPM - 22°)	Inlet	56	64	75	84	83	82	83	78	90
HCF 100 T4/T8 14/3,5kW (A3:4) F400 (1420 RPM - 40°)	Inlet	68	75	81	87	90	91	92	86	97
HCF 100 T4/T8 14/3,5kW (A3:4) F400 (720 RPM - 40°)	Inlet	52	59	66	71	75	75	76	70	81
HCF 100 T4/T8 14/3,5kW (A3:8) F400 (1420 RPM - 32°)	Inlet	71	79	84	90	93	94	95	89	100
HCF 100 T4/T8 14/3,5kW (A3:8) F400 (1420 RPM - 30°)	Inlet	72	79	86	91	95	95	96	90	101
HCF 100 T4/T8 14/3,5kW (A3:8) F400 (720 RPM - 32°)	Inlet	55	63	68	74	77	78	79	73	84
HCF 100 T4/T8 14/3,5kW (A3:8) F400 (720 RPM - 30°)	Inlet	56	63	70	75	79	79	80	74	85
HCF 100 T4/T8 17/4,3kW (A3:8) F400 (1420 RPM - 36°)	Inlet	70	77	82	87	91	93	94	87	99
HCF 100 T4/T8 17/4,3kW (A3:8) F400 (1420 RPM - 34°)	Inlet	71	78	83	88	92	93	94	88	99

		Sound power Lw dB (A)								
Model		63 Hz	125 Hz	250 Hz	500 Hz	1000 Hz	2000 Hz	4000 Hz	8000 Hz	Total
HCF 100 T4/T8 17/4,3kW (A3:8) F400 (720 RPM - 36°)	Inlet	54	61	66	71	75	77	78	72	83
HCF 100 T4/T8 17/4,3kW (A3:8) F400 (720 RPM - 34°)	Inlet	55	62	67	72	76	77	78	72	83
HCF 100 T4/T8 20/5kW (A3:8) F400 (1420 RPM - 38°)	Inlet	71	78	83	88	92	94	94	88	99
HCF 100 T4/T8 20/5kW (A3:8) F400 (1420 RPM - 40°)	Inlet	71	79	84	89	92	94	95	89	100
HCF 100 T4/T8 20/5kW (A3:8) F400 (720 RPM - 40°)	Inlet	56	63	68	73	76	78	79	73	84
HCF 100 T4/T8 20/5kW (A3:8) F400 (720 RPM - 38°)	Inlet	55	62	67	72	76	78	78	72	83
HCF 112 T4/T8 5,5/1,1kW (A3:4) F400 (1420 RPM - 20°)	Inlet	66	78	83	90	94	94	96	92	101
HCF 112 T4/T8 5,5/1,1kW (A3:4) F400 (720 RPM - 20°)	Inlet	50	62	67	74	78	78	80	76	85
HCF 112 T4/T8 7,5/1,5kW (A3:4) F400 (1420 RPM - 22°)	Inlet	68	79	84	90	94	95	96	92	102
HCF 112 T4/T8 7,5/1,5kW (A3:4) F400 (1420 RPM - 24°)	Inlet	69	78	83	90	93	94	96	91	101
HCF 112 T4/T8 7,5/1,5kW (A3:4) F400 (720 RPM - 24°)	Inlet	53	62	67	74	77	78	80	75	85
HCF 112 T4/T8 7,5/1,5kW (A3:4) F400 (720 RPM - 22°)	Inlet	52	63	68	74	78	79	81	76	86
HCF 112 T4/T8 11/3kW (A3:4) F400 (1420 RPM - 32°)	Inlet	70	77	82	87	91	92	94	87	98
HCF 112 T4/T8 11/3kW (A3:4) F400 (1420 RPM - 30°)	Inlet	71	78	83	88	92	93	94	88	99
HCF 112 T4/T8 11/3kW (A3:4) F400 (1420 RPM - 28°)	Inlet	71	78	83	89	92	93	95	89	99
HCF 112 T4/T8 11/3kW (A3:4) F400 (1420 RPM - 26°)	Inlet	70	78	83	89	93	94	95	90	100
HCF 112 T4/T8 11/3kW (A3:4) F400 (720 RPM - 32°)	Inlet	55	61	67	72	75	76	78	71	82
HCF 112 T4/T8 11/3kW (A3:4) F400 (720 RPM - 30°)	Inlet	55	62	67	72	76	77	78	72	83
HCF 112 T4/T8 11/3kW (A3:4) F400 (720 RPM - 28°)	Inlet	55	62	67	73	76	77	79	73	83
HCF 112 T4/T8 11/3kW (A3:4) F400 (720 RPM - 26°)	Inlet	54	62	67	73	77	78	79	74	84
HCF 112 T4/T8 11/3kW (A3:8) F400 (1420 RPM - 20°)	Inlet	73	82	92	101	101	103	103	97	109
HCF 112 T4/T8 11/3kW (A3:8) F400 (720 RPM - 20°)	Inlet	57	66	76	85	85	87	87	81	93
HCF 112 T4/T8 14/3,5kW (A3:4) F400 (1420 RPM - 34°)	Inlet	70	76	82	87	90	92	93	86	98

		Sound power Lw dB (A)								
Model		63 Hz	125 Hz	250 Hz	500 Hz	1000 Hz	2000 Hz	4000 Hz	8000 Hz	Total
HCF 112 T4/T8 14/3,5kW (A3:4) F400 (1420 RPM - 36°)	Inlet	71	76	83	87	90	92	93	86	98
HCF 112 T4/T8 14/3,5kW (A3:4) F400 (720 RPM - 36°)	Inlet	55	60	67	71	74	76	77	70	82
HCF 112 T4/T8 14/3,5kW (A3:4) F400 (720 RPM - 34°)	Inlet	54	60	66	71	74	76	77	70	82
HCF 112 T4/T8 14/3,5kW (A3:8) F400 (1420 RPM - 26°)	Inlet	74	81	89	96	98	100	100	94	106
HCF 112 T4/T8 14/3,5kW (A3:8) F400 (1420 RPM - 24°)	Inlet	73	81	90	97	99	101	101	95	106
HCF 112 T4/T8 14/3,5kW (A3:8) F400 (1420 RPM - 22°)	Inlet	73	81	91	99	100	102	102	96	107
HCF 112 T4/T8 14/3,5kW (A3:8) F400 (720 RPM - 26°)	Inlet	58	65	73	80	83	84	84	78	90
HCF 112 T4/T8 14/3,5kW (A3:8) F400 (720 RPM - 24°)	Inlet	57	65	74	81	83	85	85	79	90
HCF 112 T4/T8 14/3,5kW (A3:8) F400 (720 RPM - 22°)	Inlet	57	65	75	83	84	86	86	80	91
HCF 112 T4/T8 17/4,3kW (A3:4) F400 (1420 RPM - 40°)	Inlet	72	79	84	89	91	93	94	87	99
HCF 112 T4/T8 17/4,3kW (A3:4) F400 (1420 RPM - 38°)	Inlet	71	77	83	88	91	92	93	87	98
HCF 112 T4/T8 17/4,3kW (A3:4) F400 (720 RPM - 40°)	Inlet	56	63	68	73	76	77	78	71	83
HCF 112 T4/T8 17/4,3kW (A3:4) F400 (720 RPM - 38°)	Inlet	55	61	67	72	75	76	78	71	82
HCF 112 T4/T8 17/4,3kW (A3:8) F400 (1420 RPM - 30°)	Inlet	74	80	87	93	97	99	99	93	104
HCF 112 T4/T8 17/4,3kW (A3:8) F400 (1420 RPM - 28°)	Inlet	74	81	88	94	98	99	99	94	105
HCF 112 T4/T8 17/4,3kW (A3:8) F400 (720 RPM - 30°)	Inlet	58	65	72	77	81	83	83	77	88
HCF 112 T4/T8 17/4,3kW (A3:8) F400 (720 RPM - 28°)	Inlet	58	65	72	78	82	83	83	78	89
HCF 112 T4/T8 20/5kW (A3:8) F400 (1420 RPM - 32°)	Inlet	74	81	86	91	96	97	97	91	103
HCF 112 T4/T8 20/5kW (A3:8) F400 (720 RPM - 32°)	Inlet	58	65	70	76	80	81	81	75	87
HCF 112 T4/T8 28/6,5kW (A3:8) F400 (1420 RPM - 34°)	Inlet	73	80	85	90	94	96	96	89	101
HCF 112 T4/T8 28/6,5kW (A3:8) F400 (1420 RPM - 40°)	Inlet	74	81	86	90	94	96	95	90	101
HCF 112 T4/T8 28/6,5kW (A3:8) F400 (1420 RPM - 38°)	Inlet	73	80	85	90	94	96	95	89	101
HCF 112 T4/T8 28/6,5kW (A3:8) F400 (1420 RPM - 36°)	Inlet	73	80	85	90	93	95	95	89	101

		Sound power Lw dB (A)								
Model		63 Hz	125 Hz	250 Hz	500 Hz	1000 Hz	2000 Hz	4000 Hz	8000 Hz	Total
HCF 112 T4/T8 28/6,5kW (A3:8) F400 (720 RPM - 40°)	Inlet	58	65	70	74	78	80	80	74	85
HCF 112 T4/T8 28/6,5kW (A3:8) F400 (720 RPM - 38°)	Inlet	57	64	69	74	78	80	80	73	85
HCF 112 T4/T8 28/6,5kW (A3:8) F400 (720 RPM - 36°)	Inlet	57	64	69	74	77	79	80	73	85
HCF 112 T4/T8 28/6,5kW (A3:8) F400 (720 RPM - 34°)	Inlet	57	64	69	74	78	80	80	73	85
HCF 125 T4/T8 11/3kW (A3:4) F400 (1420 RPM - 22°)	Inlet	75	86	91	98	102	103	105	101	109
HCF 125 T4/T8 11/3kW (A3:4) F400 (1420 RPM - 20°)	Inlet	72	85	90	98	102	102	104	101	109
HCF 125 T4/T8 11/3kW (A3:4) F400 (720 RPM - 22°)	Inlet	59	70	75	82	86	87	89	85	93
HCF 125 T4/T8 11/3kW (A3:4) F400 (720 RPM - 20°)	Inlet	56	69	74	82	86	86	88	85	93
HCF 125 T4/T8 14/3,5kW (A3:4) F400 (1420 RPM - 26°)	Inlet	76	84	89	94	98	99	101	95	106
HCF 125 T4/T8 14/3,5kW (A3:4) F400 (1420 RPM - 24°)	Inlet	75	85	90	96	100	101	103	98	107
HCF 125 T4/T8 14/3,5kW (A3:4) F400 (720 RPM - 26°)	Inlet	60	68	73	78	82	83	85	80	90
HCF 125 T4/T8 14/3,5kW (A3:4) F400 (720 RPM - 24°)	Inlet	59	69	74	80	84	85	87	82	91
HCF 125 T4/T8 17/4,3kW (A3:4) F400 (1420 RPM - 28°)	Inlet	75	82	87	93	96	98	99	93	104
HCF 125 T4/T8 17/4,3kW (A3:4) F400 (1420 RPM - 30°)	Inlet	74	81	86	91	95	96	97	91	102
HCF 125 T4/T8 17/4,3kW (A3:4) F400 (720 RPM - 30°)	Inlet	58	65	70	75	79	80	81	75	86
HCF 125 T4/T8 17/4,3kW (A3:4) F400 (720 RPM - 28°)	Inlet	60	67	72	77	80	82	83	77	88
HCF 125 T4/T8 20/5kW (A3:4) F400 (1420 RPM - 34°)	Inlet	73	80	85	90	93	95	96	88	101
HCF 125 T4/T8 20/5kW (A3:4) F400 (1420 RPM - 32°)	Inlet	74	81	86	90	94	96	96	90	102
HCF 125 T4/T8 20/5kW (A3:4) F400 (720 RPM - 34°)	Inlet	58	65	70	74	77	79	80	72	85
HCF 125 T4/T8 20/5kW (A3:4) F400 (720 RPM - 32°)	Inlet	58	65	70	75	78	80	81	74	86
HCF 125 T4/T8 20/5kW (A3:8) F400 (1420 RPM - 24°)	Inlet	78	85	92	100	106	108	108	102	113
HCF 125 T4/T8 20/5kW (A3:8) F400 (1420 RPM - 22°)	Inlet	79	86	93	102	107	110	109	104	114
HCF 125 T4/T8 20/5kW (A3:8) F400 (1420 RPM - 20°)	Inlet	78	86	93	103	108	111	110	105	115

		Sound power Lw dB (A)								
Model		63 Hz	125 Hz	250 Hz	500 Hz	1000 Hz	2000 Hz	4000 Hz	8000 Hz	Total
HCF 125 T4/T8 20/5kW (A3:8) F400 (720 RPM - 24°)	Inlet	62	70	76	84	90	92	92	86	97
HCF 125 T4/T8 20/5kW (A3:8) F400 (720 RPM - 22°)	Inlet	63	70	77	86	91	94	93	88	98
HCF 125 T4/T8 20/5kW (A3:8) F400 (720 RPM - 20°)	Inlet	62	71	78	87	92	95	94	89	99
HCF 125 T4/T8 28/6,5kW (A3:4) F400 (1420 RPM - 40°)	Inlet	75	82	87	91	93	96	96	89	102
HCF 125 T4/T8 28/6,5kW (A3:4) F400 (1420 RPM - 38°)	Inlet	74	81	86	91	93	95	96	89	101
HCF 125 T4/T8 28/6,5kW (A3:4) F400 (1420 RPM - 36°)	Inlet	74	81	86	90	93	95	96	88	101
HCF 125 T4/T8 28/6,5kW (A3:4) F400 (720 RPM - 40°)	Inlet	59	66	71	75	78	80	80	73	86
HCF 125 T4/T8 28/6,5kW (A3:4) F400 (720 RPM - 38°)	Inlet	58	65	70	75	77	79	80	73	85
HCF 125 T4/T8 28/6,5kW (A3:4) F400 (720 RPM - 36°)	Inlet	58	65	70	74	77	79	80	72	85
HCF 125 T4/T8 28/6,5kW (A3:8) F400 (1420 RPM - 30°)	Inlet	77	83	90	96	101	103	104	97	108
HCF 125 T4/T8 28/6,5kW (A3:8) F400 (1420 RPM - 28°)	Inlet	78	84	91	97	102	105	105	98	110
HCF 125 T4/T8 28/6,5kW (A3:8) F400 (1420 RPM - 26°)	Inlet	78	85	91	98	104	106	106	100	111
HCF 125 T4/T8 28/6,5kW (A3:8) F400 (720 RPM - 30°)	Inlet	62	67	74	80	85	87	88	81	92
HCF 125 T4/T8 28/6,5kW (A3:8) F400 (720 RPM - 28°)	Inlet	62	68	75	81	86	89	89	82	94
HCF 125 T4/T8 28/6,5kW (A3:8) F400 (720 RPM - 26°)	Inlet	62	69	75	82	88	90	90	84	95
HCF 125 T4/T8 37/9,2kW (A3:8) F400 (1420 RPM - 36°)	Inlet	77	83	89	93	96	98	98	91	104
HCF 125 T4/T8 37/9,2kW (A3:8) F400 (1420 RPM - 34°)	Inlet	77	83	89	94	97	99	100	92	105
HCF 125 T4/T8 37/9,2kW (A3:8) F400 (1420 RPM - 32°)	Inlet	77	83	89	95	99	102	102	94	107
HCF 125 T4/T8 37/9,2kW (A3:8) F400 (720 RPM - 36°)	Inlet	61	68	73	77	81	83	82	75	88
HCF 125 T4/T8 37/9,2kW (A3:8) F400 (720 RPM - 34°)	Inlet	61	68	73	78	81	84	84	76	89
HCF 125 T4/T8 37/9,2kW (A3:8) F400 (720 RPM - 32°)	Inlet	61	67	73	79	83	86	86	79	91
HCF 125 T4/T8 44/11kW (A3:8) F400 (1420 RPM - 40°)	Inlet	76	83	88	93	96	98	97	90	103
HCF 125 T4/T8 44/11kW (A3:8) F400 (1420 RPM - 38°)	Inlet	76	83	88	93	96	98	97	91	104

Sound power Lw dB (A)										
Model		63 Hz	125 Hz	250 Hz	500 Hz	1000 Hz	2000 Hz	4000 Hz	8000 Hz	Total
HCF 125 T4/T8 44/11kW (A3:8) F400 (720 RPM - 40°)	Inlet	60	67	72	77	80	82	81	74	87
HCF 125 T4/T8 44/11kW (A3:8) F400 (720 RPM - 38°)	Inlet	60	67	72	77	80	82	82	75	88

erp data

ERP	
Fan type	Axial fan
Instalation catgory	A
Efficency catgory	Static
The fan has to be installed with FSC	No

ERP / 4 poles

Model	Motor power (kW)	Maximum efficiency point data						
		Max. efficiency (%)	Efficiency grade (N) (N)	Air Flow (m3/h)	Ps (Pa)	Pabs (kW)	speed (rpm)	Specific ratio
HCF 45 T4 0,75kW (A5:6) F400 (°)	0,75	25,22	34,25	3.938,40	91,48	0,37	1404	1,00
HCF 50 T4 0,75kW (A5:6) F400 (°)	0,75	33,75	41,93	5.631,13	108,38	0,51	1404	1,00
HCF 56 T4 0,75kW (A5:6) F400 (°)	0,75	38,49	46,08	5.286,46	156,65	0,63	1404	1,00
HCF 56 T4 0,75kW (A5:6) F400 (°)	0,75	38,91	45,71	6.799,71	163,76	0,84	1404	1,00
HCF 56 T4 0,75kW (A5:6) F400 (°)	0,75	40,36	47,48	6.377,29	162,70	0,75	1404	1,00
HCF 56 T4 1,1kW (A5:6) F400 (°)	1,1	35,94	41,99	7.864,11	175,27	1,11	1392	1,00
HCF 56 T4 1,1kW (A5:6) F400 (°)	1,1	37,33	43,85	7.198,19	163,79	0,93	1392	1,00
HCF 56 T4 1,5kW (A5:6) F400 (°)	1,5	35,35	41	8.575,19	185,04	1,28	1410	1,00
HCF 56 T4 1,5kW (A5:6) F400 (°)	1,5	35,43	40,72	9.299,95	193,09	1,46	1410	1,00
HCF 63 T4 0,75kW (A5:6) F400 (°)	0,75	46,63	53,25	7.384,78	192,08	0,90	1404	1,00
HCF 63 T4 1,1kW (A5:6) F400 (°)	1,1	46,52	52,17	9.056,31	221,36	1,28	1392	1,00
HCF 63 T4 1,5kW (A5:6) F400 (°)	1,5	42,12	47,20	10.066,20	229,21	1,58	1410	1,00
HCF 63 T4 1,5kW (A5:6) F400 (°)	1,5	44,39	49,74	9.588,71	224,77	1,43	1410	1,00
HCF 63 T4 2,2kW (A5:6) F400 (°)	2,2	38,35	42,73	11.588,88	230,37	2,03	1420	1,00
HCF 63 T4 2,2kW (A5:6) F400 (°)	2,2	40,03	44,74	10.830,65	229,31	1,81	1420	1,00
HCF 71 T4 0,75kW (A5:6) F400 (°)	0,75	47,01	53,39	7.908,74	201,69	0,98	1404	1,00
HCF 71 T4 1,1kW (A5:6) F400 (°)	1,1	45,67	51,11	9.865,86	221,15	1,39	1392	1,00
HCF 71 T4 1,5kW (A5:6) F400 (°)	1,5	46,22	50,95	11.855,32	240,58	1,80	1410	1,00
HCF 71 T4 2,2kW (A5:6) F400 (°)	2,2	42,32	46,19	14.007,05	256,86	2,46	1420	1,00
HCF 71 T4 2,2kW (A5:6) F400 (°)	2,2	43,85	48,11	12.922	248,26	2,13	1420	1,00
HCF 71 T4 3kW (A5:6) F400 (°)	3	39,37	42,79	15.295,05	255,96	2,89	1420	1,00
HCF 71 T4 3kW (A5:6) F400 (°)	3	40,72	44,36	14.637,66	255,51	2,67	1420	1,00
HCF 80 T4 3kW (A5:6) F400 (°)	3	47,47	50,44	18.603,39	298,09	3,41	1420	1,00
HCF 80 T4 3kW (A5:6) F400 (°)	3	49,89	53,19	17.421,07	297,07	3,02	1420	1,00
HCF 80 T4 3kW (A5:6) F400 (°)	3	53,27	56,95	16.269,95	295,38	2,63	1420	1,00
HCF 80 T4 4kW (A5:6) F400 (°)	4	46,01	48,67	20.008,80	305,30	3,81	1428	1,00
HCF 80 T4 4kW (A5:6) F400 (°)	4	45,44	47,83	21.569,23	310,17	4,22	1428	1,00
HCF 90 T4 3kW (A3:4) F400 (°)	3	48,40	51,64	16.269,79	312,06	3,09	1420	1,00



Model	Motor power (kW)	Maximum efficiency point data						
		Max. efficiency (%)	Efficiency grade (N) (N)	Air Flow (m3/h)	Ps (Pa)	Pabs (kW)	speed (rpm)	Specific ratio
HCF 90 T4 3kW (A3:4) F400 (°)	3	49,88	53,58	14.806,82	298,15	2,61	1420	1,00
HCF 90 T4 4kW (A3:4) F400 (°)	4	46,06	48,49	19.259,13	340,14	4,15	1428	1,00
HCF 90 T4 4kW (A3:4) F400 (°)	4	47,50	50,34	17.768,06	326,89	3,58	1428	1,00
HCF 90 T4 5,5kW (A3:4) F400 (°)	5,5	43,92	45,63	22.345,93	367,81	5,41	1450	1,00
HCF 90 T4 5,5kW (A3:4) F400 (°)	5,5	45,22	47,29	20.822,29	353,92	4,73	1450	1,00
HCF 90 T4 5,5kW (A3:4) F400 (°)	5,5	42,44	43,93	23.455,15	367,14	5,86	1450	1,00
HCF 90 T4 5,5kW (A3:8) F400 (°)	5,5	47,68	49,45	17.497,66	461,40	5,27	1450	1,00
HCF 90 T4 5,5kW (A3:8) F400 (°)	5,5	48,67	50,84	15.786,74	450,04	4,57	1450	1,00
HCF 90 T4 5,5kW (A3:8) F400 (°)	5,5	46,56	47,96	19.242,52	472,46	6,05	1450	1,00
HCF 90 T4 7,5kW (A3:4) F400 (°)	7,5	41,38	42,67	24.607,17	366,35	6,30	1453	1,00
HCF 90 T4 7,5kW (A3:4) F400 (°)	7,5	37,31	38,09	27.009,72	360,41	7,58	1453	1,00
HCF 90 T4 7,5kW (A3:4) F400 (°)	7,5	39,50	40,55	25.787,41	364,05	6,88	1453	1,00
HCF 90 T4 7,5kW (A3:8) F400 (°)	7,5	45,05	45,76	22.907,92	496,52	7,76	1453	1,00
HCF 90 T4 7,5kW (A3:8) F400 (°)	7,5	46,06	47,13	21.070,55	483,55	6,84	1453	1,00
HCF 90 T4 11kW (A3:4) F400 (°)	11	35,47	36,01	28.252,71	356,23	8,28	1470	1,00
HCF 90 T4 11kW (A3:8) F400 (°)	11	40,70	40,69	29.199,51	527,28	11,30	1470	1,00
HCF 90 T4 11kW (A3:8) F400 (°)	11	41,82	41,88	27.753,29	520,19	10,39	1470	1,00
HCF 90 T4 11kW (A3:8) F400 (°)	11	43,24	43,40	26.309,90	515,21	9,50	1470	1,00
HCF 90 T4 11kW (A3:8) F400 (°)	11	44,52	44,93	24.798,94	510,53	8,67	1470	1,00
HCF 90 T4 15kW (A3:8) F400 (°)	15	38,50	38,36	32.064,08	543,37	13,28	1465	1,00
HCF 90 T4 15kW (A3:8) F400 (°)	15	39,99	39,92	30.693,75	535,39	12,16	1465	1,00
HCF 100 T4 5,5kW (A3:4) F400 (°)	5,5	51,87	53,30	26.551,96	401	5,98	1450	1,00
HCF 100 T4 5,5kW (A3:4) F400 (°)	5,5	53,50	55,28	24.581,71	393,08	5,28	1450	1,00
HCF 100 T4 5,5kW (A3:4) F400 (°)	5,5	55,29	57,42	22.619,79	386,25	4,64	1450	1,00
HCF 100 T4 5,5kW (A3:4) F400 (°)	5,5	56,41	58,86	20.842,55	377,22	4,11	1450	1,00
HCF 100 T4 7,5kW (A3:4) F400 (°)	7,5	49,06	49,88	30.676,32	415,55	7,49	1453	1,00
HCF 100 T4 7,5kW (A3:4) F400 (°)	7,5	50,77	51,90	28.592,36	409,27	6,67	1453	1,00
HCF 100 T4 7,5kW (A3:8) F400 (°)	7,5	55,47	56,16	23.417,68	607,83	7,82	1453	1,00
HCF 100 T4 11kW (A3:4) F400 (°)	11	41,52	41,52	37.883,88	424,19	11,15	1470	1,00
HCF 100 T4 11kW (A3:4) F400 (°)	11	43,81	43,89	35.974,38	428,43	10,10	1470	1,00
HCF 100 T4 11kW (A3:4) F400 (°)	11	45,92	46,20	34.144,20	427,62	9,11	1470	1,00
HCF 100 T4 11kW (A3:4) F400 (°)	11	47,76	48,32	32.382,92	421,97	8,22	1470	1,00
HCF 100 T4 11kW (A3:8) F400 (°)	11	51,03	51,01	31.641,86	617,34	11,55	1470	1,00
HCF 100 T4 11kW (A3:8) F400 (°)	11	53,94	54,11	27.456,87	612,59	9,47	1470	1,00
HCF 100 T4 11kW (A3:8) F400 (°)	11	55,20	55,65	25.420,36	610,20	8,56	1470	1,00
HCF 100 T4 11kW (A3:8) F400 (°)	11	52,54	52,58	29.528,86	615,77	10,48	1470	1,00
HCF 100 T4 15kW (A3:4) F400 (°)	15	39,45	39,38	39.773,65	420,72	12,24	1465	1,00
HCF 100 T4 15kW (A3:8) F400 (°)	15	47,09	46,83	38.099,12	641,83	15,45	1465	1,00

Model	Motor power (kW)	Maximum efficiency point data						
		Max. efficiency (%)	Efficiency grade (N) (N)	Air Flow (m3/h)	Ps (Pa)	Pabs (kW)	speed (rpm)	Specific ratio
HCF 100 T4 15kW (A3:8) F400 (°)	15	48,58	48,41	35.858,39	631,14	13,92	1465	1,00
HCF 100 T4 15kW (A3:8) F400 (°)	15	50,05	49,95	33.667,23	620,57	12,57	1465	1,00
HCF 100 T4 18,5kW (A3:8) F400 (°)	18,5	43,92	43,51	42.881,99	657,50	18,71	1465	1,00
HCF 100 T4 18,5kW (A3:8) F400 (°)	18,5	45,47	45,14	40.435,64	650,15	17,04	1465	1,00
HCF 100 T4 22kW (A3:8) F400 (°)	22	42,42	41,94	45.506,86	663,64	20,54	1465	1,00
HCF 112 T4 5,5kW (A3:4) F400 (°)	5,5	58,57	60,07	25.650,99	454,24	5,82	1450	1,00
HCF 112 T4 7,5kW (A3:4) F400 (°)	7,5	57,62	58,79	28.722,21	445,68	6,56	1453	1,00
HCF 112 T4 7,5kW (A3:4) F400 (°)	7,5	56,18	57,03	31.958,45	439,65	7,40	1453	1,00
HCF 112 T4 11kW (A3:4) F400 (°)	11	50,77	50,76	45.167,47	447,36	11,30	1470	1,00
HCF 112 T4 11kW (A3:4) F400 (°)	11	52,52	52,59	42.650,78	440,51	10,20	1470	1,00
HCF 112 T4 11kW (A3:4) F400 (°)	11	54,03	54,29	38.950,75	437	9,18	1470	1,00
HCF 112 T4 11kW (A3:4) F400 (°)	11	55,47	56,03	35.408,75	436,25	8,21	1470	1,00
HCF 112 T4 11kW (A3:8) F400 (°)	11	59,52	59,49	33.497,64	695,11	11,64	1470	1,00
HCF 112 T4 11kW (A3:8) F400 (°)	11	59,41	59,44	30.195,59	708	10,66	1470	1,00
HCF 112 T4 15kW (A3:8) F400 (°)	15	57,78	57,60	40.666,11	670,97	14,07	1465	1,00
HCF 112 T4 15kW (A3:8) F400 (°)	15	59,10	58,99	37.062,48	681,23	12,72	1465	1,00
HCF 112 T4 15kW (A3:8) F400 (°)	15	56,50	56,24	44.285,27	663,23	15,50	1465	1,00
HCF 112 T4 18,5kW (A3:8) F400 (°)	18,5	53,40	52,98	51.076,20	674,33	18,96	1465	1,00
HCF 112 T4 18,5kW (A3:8) F400 (°)	18,5	55,48	55,15	47.984,32	657,81	16,90	1465	1,00
HCF 112 T4 22kW (A3:8) F400 (°)	22	51,62	51,12	54.223,31	690,24	21,10	1465	1,00
HCF 112 T4 22kW (A3:8) F400 (°)	22	49,77	49,20	57.042,61	699,22	23,14	1465	1,00
HCF 112 T4 30kW (A3:8) F400 (°)	30	46,45	45,76	62.509,16	704,62	27,06	1470	1,00
HCF 112 T4 30kW (A3:8) F400 (°)	30	48,48	47,85	59.738,16	701,78	24,86	1470	1,00
HCF 125 T4 11kW (A3:4) F400 (°)	11	58,21	58,24	38.867,01	544,20	10,72	1470	1,00
HCF 125 T4 11kW (A3:4) F400 (°)	11	59,70	59,89	34.627,57	555,89	9,43	1470	1,00
HCF 125 T4 15kW (A3:4) F400 (°)	15	54,41	54,17	52.641,94	533,79	15,06	1465	1,00
HCF 125 T4 15kW (A3:4) F400 (°)	15	55,99	55,85	47.908,39	532,86	13,44	1465	1,00
HCF 125 T4 15kW (A3:4) F400 (°)	15	57,13	57,08	43.235,32	536,37	12,01	1465	1,00
HCF 125 T4 18,5kW (A3:4) F400 (°)	18,5	51,38	50,99	60.950,03	546,90	18,40	1465	1,00
HCF 125 T4 18,5kW (A3:4) F400 (°)	18,5	53,14	52,83	57.616,06	538,43	16,65	1465	1,00
HCF 125 T4 18,5kW (A3:8) F400 (°)	18,5	60,33	59,91	45.513,87	844,37	18,92	1465	1,00
HCF 125 T4 18,5kW (A3:8) F400 (°)	18,5	60,17	59,82	40.816,50	865,45	17,39	1465	1,00
HCF 125 T4 22kW (A3:4) F400 (°)	22	46,40	45,84	67.695,79	552,09	22,74	1465	1,00
HCF 125 T4 22kW (A3:4) F400 (°)	22	49,42	48,94	64.631,14	554,34	20,49	1465	1,00
HCF 125 T4 22kW (A3:8) F400 (°)	22	59,65	59,16	50.101,18	832,37	20,84	1465	1,00
HCF 125 T4 22kW (A3:8) F400 (°)	22	58,26	57,69	54.888,01	820,52	23,04	1465	1,00
HCF 125 T4 30kW (A3:8) F400 (°)	30	55,98	55,28	64.842,17	805,03	27,60	1470	1,00
HCF 125 T4 30kW (A3:8) F400 (°)	30	57,49	56,85	59.887,35	810,69	25,16	1470	1,00



Model	Motor power (kW)	Maximum efficiency point data						
		Max. efficiency (%)	Efficiency grade (N) (N)	Air Flow (m3/h)	Ps (Pa)	Pabs (kW)	speed (rpm)	Specific ratio
HCF 125 T4 30kW (A3:8) F400 (°)	30	53,89	53,09	68.709,09	827,35	30,96	1470	1,00
HCF 125 T4 37kW (A3:8) F400 (°)	37	50,51	49,55	77.349,10	853,45	37,87	1475	1,00
HCF 125 T4 37kW (A3:8) F400 (°)	37	52,01	51,13	73.025,87	843,98	34,43	1475	1,00
HCF 125 T4 45kW (A3:8) F400 (°)	45	46,52	45,44	84.191,86	861,51	44,34	1475	1,00
HCF 125 T4 45kW (A3:8) F400 (°)	45	48,98	47,97	80.875,45	856,90	40,79	1475	1,00

ERP / 6 poles

Model	Motor power (kW)	Maximum efficiency point data						
		Max. efficiency (%)	Efficiency grade (N) (N)	Air Flow (m3/h)	Ps (Pa)	Pabs (kW)	speed (rpm)	Specific ratio
HCF 50 T6 0,75kW (A5:6) F400 (°)	0,75	26,51	37,89	3.801,51	49,14	0,16	923	1,00
HCF 56 T6 0,75kW (A5:6) F400 (°)	0,55	30,33	38,94	5.459,45	84,52	0,44	923	1,00
HCF 63 T6 0,75kW (A5:6) F400 (°)	0,55	34,06	41,69	7.615,85	94,49	0,62	923	1,00
HCF 71 T6 0,75kW (A5:6) F400 (°)	0,75	30,27	36,76	9.801,75	101,01	0,94	923	1,00
HCF 71 T6 0,75kW (A5:6) F400 (°)	0,75	31,83	38,57	9.342,20	101,35	0,86	923	1,00
HCF 71 T6 0,75kW (A5:6) F400 (°)	0,75	33,76	40,76	8.892	102,10	0,78	923	1,00
HCF 80 T6 0,75kW (A5:6) F400 (°)	0,75	46,42	53,13	10.781,95	130,20	0,87	923	1,00
HCF 80 T6 1,1kW (A5:6) F400 (°)	1,1	45,75	52,11	11.564,61	135,49	0,99	920	1,00
HCF 80 T6 1,1kW (A5:6) F400 (°)	1,1	45,38	51,44	12.346,06	140,98	1,11	920	1,00
HCF 80 T6 1,5kW (A5:6) F400 (°)	1,5	43,39	49,15	13.270,90	139,67	1,23	933	1,00
HCF 80 T6 1,5kW (A5:6) F400 (°)	1,5	42,03	47,52	14.230,04	138,45	1,36	933	1,00
HCF 80 T6 2,2kW (A5:6) F400 (°)	2,2	35,88	40,81	15.634,47	132,64	1,67	948	1,00
HCF 90 T6 1,5kW (A3:4) F400 (°)	1,5	44,99	51,97	9.583,78	124,98	0,79	933	1,00
HCF 90 T6 1,5kW (A3:4) F400 (°)	1,5	42,25	48,02	12.493,84	142,68	1,23	933	1,00
HCF 90 T6 1,5kW (A3:4) F400 (°)	1,5	44,95	51,55	10.556,97	131,26	0,91	933	1,00
HCF 90 T6 1,5kW (A3:4) F400 (°)	1,5	40,51	45,57	14.458,45	154,42	1,59	933	1,00
HCF 90 T6 1,5kW (A3:4) F400 (°)	1,5	43,62	49,78	11.508,58	137,15	1,06	933	1,00
HCF 90 T6 1,5kW (A3:4) F400 (°)	1,5	39,16	44	15.175,88	153,82	1,73	933	1,00
HCF 90 T6 1,5kW (A3:4) F400 (°)	1,5	41,76	47,18	13.448,72	148,79	1,39	933	1,00
HCF 90 T6 1,5kW (A3:8) F400 (°)	1,5	43,13	47,88	12.501,64	197,85	1,78	933	1,00
HCF 90 T6 1,5kW (A3:8) F400 (°)	1,5	44,11	49,24	11.328,69	193,42	1,55	933	1,00
HCF 90 T6 1,5kW (A3:8) F400 (°)	1,5	44,93	50,45	10.229,46	188,94	1,34	933	1,00
HCF 90 T6 2,2kW (A3:4) F400 (°)	2,2	36,98	41,41	16.731,31	152,65	2	948	1,00
HCF 90 T6 2,2kW (A3:4) F400 (°)	2,2	32,98	36,88	18.362,87	149,62	2,43	948	1,00
HCF 90 T6 2,2kW (A3:4) F400 (°)	2,2	34,92	39,08	17.489,63	151,36	2,20	948	1,00
HCF 90 T6 2,2kW (A3:4) F400 (°)	2,2	38,76	43,43	15.956,21	153,67	1,83	948	1,00

Model	Motor power (kW)	Maximum efficiency point data						
		Max. efficiency (%)	Efficiency grade (N) (N)	Air Flow (m3/h)	Ps (Pa)	Pabs (kW)	speed (rpm)	Specific ratio
HCF 90 T6 2,2kW (A3:8) F400 (°)	2,2	41,21	44,98	16.064,98	214,09	2,54	948	1,00
HCF 90 T6 2,2kW (A3:8) F400 (°)	2,2	42,13	46,22	14.838,62	208,75	2,26	948	1,00
HCF 90 T6 2,2kW (A3:8) F400 (°)	2,2	43,04	47,49	13.628,47	203,46	1,99	948	1,00
HCF 90 T6 3kW (A3:8) F400 (°)	3	38,31	41,40	18.908,19	221,14	3,26	965	1,00
HCF 90 T6 3kW (A3:8) F400 (°)	3	39,43	42,75	18.011,07	218,50	3	965	1,00
HCF 90 T6 3kW (A3:8) F400 (°)	3	40,73	44,29	17.055,17	216,34	2,75	965	1,00
HCF 90 T6 4kW (A3:8) F400 (°)	4	36,47	39,13	20.775,85	228	3,81	963	1,00
HCF 90 T6 4kW (A3:8) F400 (°)	4	37,78	40,68	19.832,49	224,67	3,50	963	1,00
HCF 100 T6 1,5kW (A3:4) F400 (°)	1,5	48	52,79	17.179,76	168,57	1,76	933	1,00
HCF 100 T6 1,5kW (A3:4) F400 (°)	1,5	51,69	57,48	13.485,58	158,21	1,22	933	1,00
HCF 100 T6 1,5kW (A3:4) F400 (°)	1,5	49,51	54,63	15.922,72	165,18	1,55	933	1,00
HCF 100 T6 1,5kW (A3:4) F400 (°)	1,5	51,08	56,56	14.653,56	161,73	1,36	933	1,00
HCF 100 T6 2,2kW (A3:4) F400 (°)	1,5	48	52,79	17.179,76	168,57	1,76	948	1,00
HCF 100 T6 2,2kW (A3:4) F400 (°)	1,5	51,69	57,48	13.485,58	158,21	1,22	948	1,00
HCF 100 T6 2,2kW (A3:4) F400 (°)	2,2	44,23	48,15	20.995,57	176,96	2,42	948	1,00
HCF 100 T6 2,2kW (A3:4) F400 (°)	2,2	45,96	50,16	19.862,23	174,86	2,18	948	1,00
HCF 100 T6 2,2kW (A3:4) F400 (°)	2,2	47,55	52,06	18.545,55	171,45	1,94	948	1,00
HCF 100 T6 2,2kW (A3:4) F400 (°)	1,5	49,51	54,63	15.922,72	165,18	1,55	948	1,00
HCF 100 T6 2,2kW (A3:4) F400 (°)	1,5	51,08	56,56	14.653,56	161,73	1,36	948	1,00
HCF 100 T6 2,2kW (A3:8) F400 (°)	2,2	51,21	55,01	16.476,91	256,68	2,51	948	1,00
HCF 100 T6 2,2kW (A3:8) F400 (°)	2,2	51,92	55,99	15.169,13	255,11	2,28	948	1,00
HCF 100 T6 3kW (A3:4) F400 (°)	3	38,98	42,10	24.548,30	178	3,23	965	1,00
HCF 100 T6 3kW (A3:4) F400 (°)	3	43,18	46,85	22.123,26	179,46	2,64	965	1,00
HCF 100 T6 3kW (A3:4) F400 (°)	3	41,08	44,48	23.289,51	179,45	2,92	965	1,00
HCF 100 T6 3kW (A3:8) F400 (°)	3	50,84	54,42	17.792,04	257,31	2,74	965	1,00
HCF 100 T6 3kW (A3:8) F400 (°)	3	47,99	51,02	20.468,71	259,15	3,34	965	1,00
HCF 100 T6 3kW (A3:8) F400 (°)	3	49,37	52,67	19.128,02	258,39	3,03	965	1,00
HCF 100 T6 4kW (A3:4) F400 (°)	4	37,30	40,18	25.772,81	176,56	3,52	963	1,00
HCF 100 T6 4kW (A3:8) F400 (°)	4	44,50	46,75	24.680,80	269,11	4,44	963	1,00
HCF 100 T6 4kW (A3:8) F400 (°)	4	45,88	48,41	23.240,09	265,30	4,01	963	1,00
HCF 100 T6 4kW (A3:8) F400 (°)	4	47,24	50,05	21.823,06	259,99	3,61	963	1,00
HCF 100 T6 5,5kW (A3:8) F400 (°)	5,5	43,47	45,48	26.154,22	273,04	4,85	960	1,00
HCF 100 T6 5,5kW (A3:8) F400 (°)	5,5	40,35	41,83	29.503,31	278,58	5,88	960	1,00
HCF 100 T6 5,5kW (A3:8) F400 (°)	5,5	41,89	43,63	27.803,89	275,54	5,34	960	1,00
HCF 112 T6 2,2kW (A3:4) F400 (°)	2,2	51,44	55,36	22.980,29	183,02	2,41	948	1,00
HCF 112 T6 2,2kW (A3:4) F400 (°)	2,2	52,53	56,76	20.748,94	183,87	2,15	948	1,00
HCF 112 T6 2,2kW (A3:4) F400 (°)	2,2	53,88	58,45	18.574,72	187,51	1,91	948	1,00
HCF 112 T6 2,2kW (A3:4) F400 (°)	2,2	54,23	59,09	16.623,41	190,80	1,71	948	1,00

Model	Motor power (kW)	Maximum efficiency point data						
		Max. efficiency (%)	Efficiency grade (N) (N)	Air Flow (m3/h)	Ps (Pa)	Pabs (kW)	speed (rpm)	Specific ratio
HCF 112 T6 3kW (A3:4) F400 (°)	3	50,81	54,47	25.245,67	183,08	2,66	965	1,00
HCF 112 T6 3kW (A3:4) F400 (°)	3	47,73	50,82	29.265,33	187,47	3,26	965	1,00
HCF 112 T6 3kW (A3:4) F400 (°)	3	49,40	52,76	27.623,78	184,84	2,95	965	1,00
HCF 112 T6 3kW (A3:8) F400 (°)	3	56	59,01	21.778,10	290,64	3,36	965	1,00
HCF 112 T6 3kW (A3:8) F400 (°)	3	55,92	59,16	19.608,60	296,90	3,08	965	1,00
HCF 112 T6 4kW (A3:4) F400 (°)	4	40,84	43,13	33.937,50	184,85	4,37	963	1,00
HCF 112 T6 4kW (A3:4) F400 (°)	4	43,64	46,18	32.509,70	189,55	3,99	963	1,00
HCF 112 T6 4kW (A3:4) F400 (°)	4	46,20	49,02	30.958,51	190,42	3,60	963	1,00
HCF 112 T6 4kW (A3:8) F400 (°)	4	53,43	55,66	28.677,77	278,34	4,46	963	1,00
HCF 112 T6 4kW (A3:8) F400 (°)	4	54,62	57,12	26.316,98	281,58	4,05	963	1,00
HCF 112 T6 4kW (A3:8) F400 (°)	4	55,86	58,64	24.040,42	285,48	3,66	963	1,00
HCF 112 T6 5,5kW (A3:4) F400 (°)	5,5	38,56	40,63	35.410,86	180,06	4,74	960	1,00
HCF 112 T6 5,5kW (A3:8) F400 (°)	5,5	52,93	54,95	31.076,68	276,36	4,82	960	1,00
HCF 112 T6 5,5kW (A3:8) F400 (°)	5,5	49,03	50,43	35.104,47	289,64	6,04	960	1,00
HCF 112 T6 5,5kW (A3:8) F400 (°)	5,5	50,96	52,67	33.100,89	283,06	5,40	960	1,00
HCF 112 T6 7,5kW (A3:8) F400 (°)	7,5	46,28	47,24	38.694,32	294,24	7,08	970	1,00
HCF 112 T6 7,5kW (A3:8) F400 (°)	7,5	47,84	49,02	36.964,24	293,63	6,55	970	1,00
HCF 112 T6 7,5kW (A3:8) F400 (°)	7,5	44,41	45,14	40.492,81	295,56	7,70	970	1,00
HCF 125 T6 3kW (A3:4) F400 (°)	3	53,40	56,30	28.018,57	225,20	3,50	965	1,00
HCF 125 T6 3kW (A3:4) F400 (°)	3	54,75	57,98	25.151,44	228,34	3,10	965	1,00
HCF 125 T6 3kW (A3:4) F400 (°)	3	56,19	59,78	22.380,14	234,07	2,72	965	1,00
HCF 125 T6 4kW (A3:4) F400 (°)	4	52,93	55,56	31.002,15	223,93	3,87	963	1,00
HCF 125 T6 4kW (A3:4) F400 (°)	4	51,57	53,88	34.126,02	224,01	4,32	963	1,00
HCF 125 T6 5,5kW (A3:4) F400 (°)	5,5	46,86	48,34	41.817,50	232,85	5,87	960	1,00
HCF 125 T6 5,5kW (A3:4) F400 (°)	5,5	49,08	50,87	39.514,98	229,55	5,24	960	1,00
HCF 125 T6 5,5kW (A3:4) F400 (°)	5,5	50,80	52,87	37.300,23	226,18	4,74	960	1,00
HCF 125 T6 5,5kW (A3:8) F400 (°)	5,5	56,65	58,09	32.472,13	349,36	5,96	960	1,00
HCF 125 T6 5,5kW (A3:8) F400 (°)	5,5	57,62	59,33	29.427,43	355,11	5,39	960	1,00
HCF 125 T6 5,5kW (A3:8) F400 (°)	5,5	57,44	59,39	26.471,98	362,86	4,95	960	1,00
HCF 125 T6 7,5kW (A3:8) F400 (°)	7,5	53,64	54,32	42.032,28	337,28	7,86	970	1,00
HCF 125 T6 7,5kW (A3:8) F400 (°)	7,5	54,83	55,77	38.760,28	340,40	7,17	970	1,00
HCF 125 T6 7,5kW (A3:8) F400 (°)	7,5	56,09	57,28	35.571,49	344,23	6,51	970	1,00
HCF 125 T6 11kW (A3:8) F400 (°)	11	46,87	46,84	52.275,06	360,26	11,53	970	1,00
HCF 125 T6 11kW (A3:8) F400 (°)	11	48,44	48,48	49.919,01	358,48	10,67	970	1,00
HCF 125 T6 11kW (A3:8) F400 (°)	11	50,25	50,35	47.408,37	353,84	9,71	970	1,00
HCF 125 T6 11kW (A3:8) F400 (°)	11	52,34	52,75	44.711,09	346,17	8,69	970	1,00
HCF 125 T6 15kW (A3:8) F400 (°)	15	45,55	45,47	54.803,88	361,22	12,43	970	1,00



ERP / 4/8 poles

Model	Motor power (kW)	Maximum efficiency point data						
		Max. efficiency (%)	Efficiency grade (N) (N)	Air Flow (m3/h)	Ps (Pa)	Pabs (kW)	speed (rpm)	Specific ratio
HCF 45 T4/T8 0,8/0,2kW (A5:6) F400 (°)	0,8/0,2	25,22	34,25	3.938,40	91,48	0,37	1500	1,00
HCF 50 T4/T8 0,8/0,2kW (A5:6) F400 (°)	0,8/0,2	33,75	41,93	5.631,13	108,38	0,51	1500	1,00
HCF 56 T4/T8 0,8/0,2kW (A5:6) F400 (°)	0,8/0,2	38,49	46,08	5.286,46	156,65	0,63	1500	1,00
HCF 56 T4/T8 0,8/0,2kW (A5:6) F400 (°)	0,8/0,2	38,91	45,71	6.799,71	163,76	0,84	1500	1,00
HCF 56 T4/T8 0,8/0,2kW (A5:6) F400 (°)	0,8/0,2	40,36	47,48	6.377,29	162,70	0,75	1500	1,00
HCF 56 T4/T8 1,2/0,3kW (A5:6) F400 (°)	1,2/0,3	35,94	41,99	7.864,11	175,27	1,11	1500	1,00
HCF 56 T4/T8 1,2/0,3kW (A5:6) F400 (°)	1,2/0,3	37,33	43,85	7.198,19	163,79	0,93	1500	1,00
HCF 56 T4/T8 1,6/0,4kW (A5:6) F400 (°)	1,6/0,4	35,35	41	8.575,19	185,04	1,28	1500	1,00
HCF 56 T4/T8 1,6/0,4kW (A5:6) F400 (°)	1,6/0,4	35,43	40,72	9.299,95	193,09	1,46	1500	1,00
HCF 63 T4/T8 0,8/0,2kW (A5:6) F400 (°)	0,8/0,2	46,63	53,25	7.384,78	192,08	0,90	1500	1,00
HCF 63 T4/T8 1,2/0,3kW (A5:6) F400 (°)	1,2/0,3	46,52	52,17	9.056,31	221,36	1,28	1500	1,00
HCF 63 T4/T8 1,6/0,4kW (A5:6) F400 (°)	1,6/0,4	42,12	47,20	10.066,20	229,21	1,58	1500	1,00
HCF 63 T4/T8 1,6/0,4kW (A5:6) F400 (°)	1,6/0,4	44,39	49,74	9.588,71	224,77	1,43	1500	1,00
HCF 63 T4/T8 2,2/0,37kW (A5:6) F400 (°)	2,2/0,37	38,35	42,73	11.588,88	230,37	2,03	1500	1,00
HCF 63 T4/T8 2,2/0,37kW (A5:6) F400 (°)	2,2/0,37	40,03	44,74	10.830,65	229,31	1,81	1500	1,00
HCF 71 T4/T8 0,8/0,2kW (A5:6) F400 (°)	0,8/0,2	47,01	53,39	7.908,74	201,69	0,98	1500	1,00
HCF 71 T4/T8 1,2/0,3kW (A5:6) F400 (°)	1,2/0,3	45,67	51,11	9.865,86	221,15	1,39	1500	1,00
HCF 71 T4/T8 1,6/0,4kW (A5:6) F400 (°)	1,6/0,4	46,22	50,95	11.855,32	240,58	1,80	1500	1,00
HCF 71 T4/T8 2,2/0,37kW (A5:6) F400 (°)	2,2/0,37	42,32	46,19	14.007,05	256,86	2,46	1500	1,00
HCF 71 T4/T8 2,2/0,37kW (A5:6) F400 (°)	2,2/0,37	43,85	48,11	12.922	248,26	2,13	1500	1,00
HCF 71 T4/T8 3/0,55kW (A5:6) F400 (°)	3/0,55	39,37	42,79	15.295,05	255,96	2,89	1500	1,00
HCF 71 T4/T8 3/0,55kW (A5:6) F400 (°)	3/0,55	40,72	44,36	14.637,66	255,51	2,67	1500	1,00
HCF 80 T4/T8 3/0,55kW (A5:6) F400 (°)	3/0,55	47,47	50,44	18.603,39	298,09	3,41	1500	1,00
HCF 80 T4/T8 3/0,55kW (A5:6) F400 (°)	3/0,55	49,89	53,19	17.421,07	297,07	3,02	1500	1,00
HCF 80 T4/T8 3/0,55kW (A5:6) F400 (°)	3/0,55	53,27	56,95	16.269,95	295,38	2,63	1500	1,00
HCF 80 T4/T8 4/0,75kW (A5:6) F400 (°)	4/0,75	46,01	48,67	20.008,80	305,30	3,81	1500	1,00
HCF 80 T4/T8 4/0,75kW (A5:6) F400 (°)	4/0,75	45,44	47,83	21.569,23	310,17	4,22	1500	1,00
HCF 90 T4/T8 2,8/0,7kW (A3:4) F400 (°)	2,8/0,7	48,40	51,64	16.269,79	312,06	3,09	1420	1,00
HCF 90 T4/T8 2,8/0,7kW (A3:4) F400 (°)	2,8/0,7	49,88	53,58	14.806,82	298,15	2,61	1420	1,00
HCF 90 T4/T8 4/0,75kW (A3:4) F400 (°)	4/0,75	46,06	48,49	19.259,13	340,14	4,15	1420	1,00
HCF 90 T4/T8 4/0,75kW (A3:4) F400 (°)	4/0,75	47,50	50,34	17.768,06	326,89	3,58	1420	1,00
HCF 90 T4/T8 5,5/1,1kW (A3:4) F400 (°)	5,5/1,1	43,92	45,63	22.345,93	367,81	5,41	1420	1,00
HCF 90 T4/T8 5,5/1,1kW (A3:4) F400 (°)	5,5/1,1	45,22	47,29	20.822,29	353,92	4,73	1420	1,00
HCF 90 T4/T8 5,5/1,1kW (A3:4) F400 (°)	5,5/1,1	42,44	43,93	23.455,15	367,14	5,86	1420	1,00
HCF 90 T4/T8 5,5/1,1kW (A3:8) F400 (°)	5,5/1,1	47,68	49,45	17.497,66	461,40	5,27	1420	1,00
HCF 90 T4/T8 5,5/1,1kW (A3:8) F400 (°)	5,5/1,1	48,67	50,84	15.786,74	450,04	4,57	1420	1,00

Model	Motor power (kW)	Maximum efficiency point data						
		Max. efficiency (%)	Efficiency grade (N) (N)	Air Flow (m3/h)	Ps (Pa)	Pabs (kW)	speed (rpm)	Specific ratio
HCF 90 T4/T8 7,5/1,5kW (A3:4) F400 (°)	7,5/1,5	41,38	42,67	24.607,17	366,35	6,30	1420	1,00
HCF 90 T4/T8 7,5/1,5kW (A3:4) F400 (°)	7,5/1,5	37,31	38,09	27.009,72	360,41	7,58	1420	1,00
HCF 90 T4/T8 7,5/1,5kW (A3:4) F400 (°)	7,5/1,5	39,50	40,55	25.787,41	364,05	6,88	1420	1,00
HCF 90 T4/T8 7,5/1,5kW (A3:4) F400 (°)	7,5/1,5	42,44	43,93	23.455,15	367,14	5,86	1420	1,00
HCF 90 T4/T8 7,5/1,5kW (A3:8) F400 (°)	7,5/1,5	45,05	45,76	22.907,92	496,52	7,76	1420	1,00
HCF 90 T4/T8 7,5/1,5kW (A3:8) F400 (°)	7,5/1,5	46,06	47,13	21.070,55	483,55	6,84	1420	1,00
HCF 90 T4/T8 7,5/1,5kW (A3:8) F400 (°)	7,5/1,5	46,56	47,96	19.242,52	472,46	6,05	1420	1,00
HCF 90 T4/T8 11/3kW (A3:4) F400 (°)	11/3	35,47	36,01	28.252,71	356,23	8,28	1420	1,00
HCF 90 T4/T8 11/3kW (A3:8) F400 (°)	11/3	40,70	40,69	29.199,51	527,28	11,30	1420	1,00
HCF 90 T4/T8 11/3kW (A3:8) F400 (°)	11/3	41,82	41,88	27.753,29	520,19	10,39	1420	1,00
HCF 90 T4/T8 11/3kW (A3:8) F400 (°)	11/3	43,24	43,40	26.309,90	515,21	9,50	1420	1,00
HCF 90 T4/T8 11/3kW (A3:8) F400 (°)	11/3	44,52	44,93	24.798,94	510,53	8,67	1420	1,00
HCF 90 T4/T8 14/3,5kW (A3:8) F400 (°)	14/3,5	38,50	38,36	32.064,08	543,37	13,28	1420	1,00
HCF 90 T4/T8 14/3,5kW (A3:8) F400 (°)	14/3,5	39,99	39,92	30.693,75	535,39	12,16	1420	1,00
HCF 100 T4/T8 5,5/1,1kW (A3:4) F400 (°)	5,5/1,1	51,87	53,30	26.551,96	401	5,98	1420	1,00
HCF 100 T4/T8 5,5/1,1kW (A3:4) F400 (°)	5,5/1,1	53,50	55,28	24.581,71	393,08	5,28	1420	1,00
HCF 100 T4/T8 5,5/1,1kW (A3:4) F400 (°)	5,5/1,1	55,29	57,42	22.619,79	386,25	4,64	1420	1,00
HCF 100 T4/T8 5,5/1,1kW (A3:4) F400 (°)	5,5/1,1	56,41	58,86	20.842,55	377,22	4,11	1420	1,00
HCF 100 T4/T8 7,5/1,5kW (A3:4) F400 (°)	7,5/1,5	49,06	49,88	30.676,32	415,55	7,49	1420	1,00
HCF 100 T4/T8 7,5/1,5kW (A3:4) F400 (°)	7,5/1,5	50,77	51,90	28.592,36	409,27	6,67	1420	1,00
HCF 100 T4/T8 7,5/1,5kW (A3:8) F400 (°)	7,5/1,5	55,47	56,16	23.417,68	607,83	7,82	1420	1,00
HCF 100 T4/T8 11/3kW (A3:4) F400 (°)	11/3	41,52	41,52	37.883,88	424,19	11,15	1420	1,00
HCF 100 T4/T8 11/3kW (A3:4) F400 (°)	11/3	43,81	43,89	35.974,38	428,43	10,10	1420	1,00
HCF 100 T4/T8 11/3kW (A3:4) F400 (°)	11/3	45,92	46,20	34.144,20	427,62	9,11	1420	1,00
HCF 100 T4/T8 11/3kW (A3:4) F400 (°)	11/3	47,76	48,32	32.382,92	421,97	8,22	1420	1,00
HCF 100 T4/T8 11/3kW (A3:8) F400 (°)	11/3	51,03	51,01	31.641,86	617,34	11,55	1420	1,00
HCF 100 T4/T8 11/3kW (A3:8) F400 (°)	11/3	53,94	54,11	27.456,87	612,59	9,47	1420	1,00
HCF 100 T4/T8 11/3kW (A3:8) F400 (°)	11/3	55,20	55,65	25.420,36	610,20	8,56	1420	1,00
HCF 100 T4/T8 11/3kW (A3:8) F400 (°)	11/3	52,54	52,58	29.528,86	615,77	10,48	1420	1,00
HCF 100 T4/T8 14/3,5kW (A3:4) F400 (°)	14/3,5	39,45	39,38	39.773,65	420,72	12,24	1420	1,00
HCF 100 T4/T8 14/3,5kW (A3:8) F400 (°)	14/3,5	48,58	48,41	35.858,39	631,14	13,92	1420	1,00
HCF 100 T4/T8 14/3,5kW (A3:8) F400 (°)	14/3,5	50,05	49,95	33.667,23	620,57	12,57	1420	1,00
HCF 100 T4/T8 17/4,3kW (A3:8) F400 (°)	17/4,3	45,47	45,14	40.435,64	650,15	17,04	1420	1,00
HCF 100 T4/T8 17/4,3kW (A3:8) F400 (°)	17/4,3	47,09	46,83	38.099,12	641,83	15,45	1420	1,00
HCF 100 T4/T8 20/5kW (A3:8) F400 (°)	20/5	43,92	43,51	42.881,99	657,50	18,71	1420	1,00
HCF 100 T4/T8 20/5kW (A3:8) F400 (°)	20/5	42,42	41,94	45.506,86	663,64	20,54	1420	1,00
HCF 112 T4/T8 5,5/1,1kW (A3:4) F400 (°)	5,5/1,1	58,57	60,07	25.650,99	454,24	5,82	1420	1,00
HCF 112 T4/T8 7,5/1,5kW (A3:4) F400 (°)	7,5/1,5	57,62	58,79	28.722,21	445,68	6,56	1420	1,00



Model	Motor power (kW)	Maximum efficiency point data						
		Max. efficiency (%)	Efficiency grade (N) (N)	Air Flow (m3/h)	Ps (Pa)	Pabs (kW)	speed (rpm)	Specific ratio
HCF 112 T4/T8 7,5/1,5kW (A3:4) F400 (°)	7,5/1,5	56,18	57,03	31.958,45	439,65	7,40	1420	1,00
HCF 112 T4/T8 11/3kW (A3:4) F400 (°)	11/3	50,77	50,76	45.167,47	447,36	11,30	1420	1,00
HCF 112 T4/T8 11/3kW (A3:4) F400 (°)	11/3	52,52	52,59	42.650,78	440,51	10,20	1420	1,00
HCF 112 T4/T8 11/3kW (A3:4) F400 (°)	11/3	54,03	54,29	38.950,75	437	9,18	1420	1,00
HCF 112 T4/T8 11/3kW (A3:4) F400 (°)	11/3	55,47	56,03	35.408,75	436,25	8,21	1420	1,00
HCF 112 T4/T8 11/3kW (A3:8) F400 (°)	11/3	59,41	59,44	30.195,59	708	10,66	1420	1,00
HCF 112 T4/T8 14/3,5kW (A3:4) F400 (°)	14/3,5	48,91	48,82	47.787,36	454,15	12,54	1420	1,00
HCF 112 T4/T8 14/3,5kW (A3:4) F400 (°)	14/3,5	46,10	45,93	50.091,11	451,84	13,88	1420	1,00
HCF 112 T4/T8 14/3,5kW (A3:8) F400 (°)	14/3,5	57,78	57,60	40.666,11	670,97	14,07	1420	1,00
HCF 112 T4/T8 14/3,5kW (A3:8) F400 (°)	14/3,5	59,10	58,99	37.062,48	681,23	12,72	1420	1,00
HCF 112 T4/T8 14/3,5kW (A3:8) F400 (°)	14/3,5	59,52	59,49	33.497,64	695,11	11,64	1420	1,00
HCF 112 T4/T8 17/4,3kW (A3:8) F400 (°)	17/4,3	55,48	55,15	47.984,32	657,81	16,90	1420	1,00
HCF 112 T4/T8 17/4,3kW (A3:8) F400 (°)	17/4,3	56,50	56,24	44.285,27	663,23	15,50	1420	1,00
HCF 112 T4/T8 20/5kW (A3:8) F400 (°)	20/5	53,40	52,98	51.076,20	674,33	18,96	1420	1,00
HCF 112 T4/T8 28/6,5kW (A3:8) F400 (°)	28/6,5	51,62	51,12	54.223,31	690,24	21,10	1420	1,00
HCF 112 T4/T8 28/6,5kW (A3:8) F400 (°)	28/6,5	46,45	45,76	62.509,16	704,62	27,06	1420	1,00
HCF 112 T4/T8 28/6,5kW (A3:8) F400 (°)	28/6,5	48,48	47,85	59.738,16	701,78	24,86	1420	1,00
HCF 112 T4/T8 28/6,5kW (A3:8) F400 (°)	28/6,5	49,77	49,20	57.042,61	699,22	23,14	1420	1,00
HCF 125 T4/T8 11/3kW (A3:4) F400 (°)	11/3	58,21	58,24	38.867,01	544,20	10,72	1420	1,00
HCF 125 T4/T8 11/3kW (A3:4) F400 (°)	11/3	59,70	59,89	34.627,57	555,89	9,43	1420	1,00
HCF 125 T4/T8 14/3,5kW (A3:4) F400 (°)	14/3,5	55,99	55,85	47.908,39	532,86	13,44	1420	1,00
HCF 125 T4/T8 14/3,5kW (A3:4) F400 (°)	14/3,5	57,13	57,08	43.235,32	536,37	12,01	1420	1,00
HCF 125 T4/T8 17/4,3kW (A3:4) F400 (°)	17/4,3	54,41	54,17	52.641,94	533,79	15,06	1420	1,00
HCF 125 T4/T8 17/4,3kW (A3:4) F400 (°)	17/4,3	53,14	52,83	57.616,06	538,43	16,65	1420	1,00
HCF 125 T4/T8 20/5kW (A3:4) F400 (°)	20/5	49,42	48,94	64.631,14	554,34	20,49	1420	1,00
HCF 125 T4/T8 20/5kW (A3:4) F400 (°)	20/5	51,38	50,99	60.950,03	546,90	18,40	1420	1,00
HCF 125 T4/T8 20/5kW (A3:8) F400 (°)	20/5	59,65	59,16	50.101,18	832,37	20,84	1420	1,00
HCF 125 T4/T8 20/5kW (A3:8) F400 (°)	20/5	60,33	59,91	45.513,87	844,37	18,92	1420	1,00
HCF 125 T4/T8 20/5kW (A3:8) F400 (°)	20/5	60,17	59,82	40.816,50	865,45	17,39	1420	1,00
HCF 125 T4/T8 28/6,5kW (A3:8) F400 (°)	28/6,5	55,98	55,28	64.842,17	805,03	27,60	1420	1,00
HCF 125 T4/T8 28/6,5kW (A3:8) F400 (°)	28/6,5	57,49	56,85	59.887,35	810,69	25,16	1420	1,00
HCF 125 T4/T8 28/6,5kW (A3:8) F400 (°)	28/6,5	58,26	57,69	54.888,01	820,52	23,04	1420	1,00
HCF 125 T4/T8 37/9,2kW (A3:8) F400 (°)	37/9,2	50,51	49,55	77.349,10	853,45	37,87	1420	1,00
HCF 125 T4/T8 37/9,2kW (A3:8) F400 (°)	37/9,2	52,01	51,13	73.025,87	843,98	34,43	1420	1,00
HCF 125 T4/T8 37/9,2kW (A3:8) F400 (°)	37/9,2	53,89	53,09	68.709,09	827,35	30,96	1420	1,00
HCF 125 T4/T8 44/11kW (A3:8) F400 (°)	44/11	46,52	45,44	84.191,86	861,51	44,34	1420	1,00
HCF 125 T4/T8 44/11kW (A3:8) F400 (°)	44/11	48,98	47,97	80.875,45	856,90	40,79	1420	1,00

